



2021 Edition

Temporary Traffic Control Manual

Foreword

This Traffic Control Manual shall be utilized in conjunction with and is intended to supplement the latest version of Manual of Uniform Traffic Control Devices for Canada (MUTCDC), as published by the Transportation Association of Canada (TAC). The basic principles embodied in the MUTCDC have been adapted to urban conditions to provide a user's guide for work within The City of Calgary jurisdiction, under the authority of The City of Calgary Bylaws 20M88 and 26M96.

We intend to provide everyone who has to work in the street with the information necessary to carry out their tasks safely. It's our desire that all crews who work in the public right-of-way set-up safe work zones that consistently and clearly convey to pedestrians, cyclists and motorists that work is being performed. All users must receive a clear message from signs, cones, delineators and barricades indicating where to travel and slow down, creating a safer environment for them and the people working in the street.

Please use this manual to help make your work zones safer and encourage others to participate in a safe working environment. A special thanks to all who contributed to the 2021 edition, making this a manual that works for all.



Anthony El-araj, P.Eng.
Traffic Leader



Ravi Seera, P.Eng.
Manager of Traffic



2021-03-25

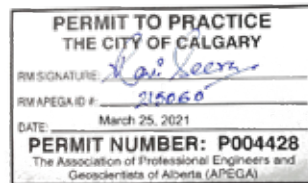

Table of contents

Telephone listings iv

Chapter 1 – Introduction

Purpose 1
 Scope 1
 Legal authority 1

Chapter 2 – Before you work on City ROW (right-of-way)

Temporary traffic control plans 2
 City of Calgary roadway classification map 3
 Worksite assessment and checklist 4
 Required permits/authorization 4
 Before the job 4
 During the job 5
 After the job 5
 Restricted areas 6
 Heavy rail ROWs (CN, CP) 6
 Light rail transit (LRT) ROWs 6
 Seventh Avenue transit corridor 6
 Provincial ROWs 6
 Stephen Avenue Mall/Barclay malls 6
 Accreditation and Personal Protective Equipment 7
 Alberta Temporary Traffic Control Accreditation 7
 Traffic Control Person (flagperson) Accreditation 7
 Field Applications Accreditation 7
 Personal Protective Equipment (PPE) 7

Chapter 3 – Performance guidelines

Pedestrian and cyclist safety	8
Standards of performance and responsibility	9
Plan	9
Communicate	10
Implement	11
Securing the worksite	12
During periods of activity	12
During periods of inactivity	12
Bridging	13
Installation, maintenance, record keeping and removal	13
Installation	13
Maintenance	13
Record keeping	14
Removal	14

Chapter 4 – Guidelines for traffic control

Fundamentals for application	15
Temporary workzone component areas	15
Basic temporary traffic control tapers and tangents criteria	17
Traffic control devices – Length and spacing guidelines	19
Duration of work	20
Traffic control devices and measures	21
Signs and specifications	21
Control of traffic using a traffic control person	30
Delineation (channelization) devices	31
Barricades	33
Traffic barriers	34
Arrow boards	35
Variable message boards	35
Impact attenuators	36
Intelligent Transportation Systems (ITS)	36
Speed fines double	37

Chapter 5 – Temporary traffic control (typical applications)

Drawing index	38
---------------------	----

Chapter 6 – Incident/emergency procedures

Guidelines for The City of Calgary personnel	117
Collisions.....	117
Roadway obstructions (i.e., debris)	118
Water pooling on roadway, sink hole or undermined pavement	118
Potential dangerous goods/hazardous materials incidents.....	119
Emergency work affecting Calgary Transit.....	119
Procedures for trained personnel assigned to emergency incidents	120
Emergency response set-up	120
Additional protective measures	120

Glossary	121
-----------------------	-----

Bibliography	126
---------------------------	-----

Appendices	127
-------------------------	-----

Appendix A – Street Use Permit	128
Appendix B – Hoarding Permit	130
Appendix C – Record of Temporary Traffic Control (Inspection Form).....	131
Appendix D – High Visibility Safety Apparel.....	132
Appendix E – Sign Sizing Guideline	136
Appendix F – Maximum Speed Ahead Sign Placement.....	144
Appendix G – Construction site contact info	145

Telephone listings

1. Utilities location system

- Alberta One Call – alberta1call.com. **1-800-242-3447**
 - Natural gas, phone, power, electric, traffic signals, street lights, water, sewer and some pipeline locations.
 - Some pipeline locations cannot be obtained from Alberta One Call. They must be obtained from the company involved.
- Shaw Cable – Dig Shaw Facility location service.
 - Local: **403-716-6035**
 - Toll free: **1-866-DigShaw (344-7429)**
- Rail companies control cable locations
 - Canadian Pacific **403-319-7000**
 - Canadian National **1-800-665-5662**

2. The City of Calgary Development & Building Approvals

- Permits – Building, Developments, Signs (private), Subdivision, Land Use and Licences. **311**

3. The City of Calgary Waste & Recycling Services

- Report work affecting garbage pickup. **311**

4. The City of Calgary Roadway Maintenance Division

- Excavation Permit Office, Manchester Building E (Bridging Authorization). **311**
- Road debris, holes, cave-ins, sanding, potholes.

-
- 5. The City of Calgary
Traffic Division** **311**
- Temporary pedestrian, bicycle and motorized traffic control set-ups and authorization.
 - Permanent signage (regulatory, warning, information and guide signs).
 - Roadmarking.
 - Pedestrian crosswalks.
 - On-street bicycle route signage.
 - Speed limits.
 - Permits (hoarding, street use, banner, over-dimensional, parade and special events, block party, special parking permits, commercial loading zone, rickshaw and pedicab, and Stampede bleacher). Apply at calgary.ca/epermits
 - Parking management (residential zones, handicap parking, loading zones).
 - Special event co-ordination.
 - School and playground zones.
 - Truck route/DGR issues.
 - Railway safety issues.
 - Local traffic bylaws and provincial legislation.
- 6. The City of Calgary
Roadway Construction and Materials** **311**
- Indemnification Agreements.
- 7. Emergency Use Only** **911**
- Police, Fire, ambulance and emergency.
- 8. Fire Department
Dispatch and Emergency Medical Services** **311**
- Report work on main thoroughfares that may affect response times.

9. Calgary Downtown Business Association

- Olympic Plaza/Stephen Avenue/Barclay Mall permits.

403-215-1570

10. The City of Calgary, Calgary Transit, Operations Section

- LRT emergency and permits.
- Report work affecting bus routes.
- Transit emergency/Transit radio control (24 hours).

403-268-1518

403-268-1570

403-268-1517

403-268-1517

403-268-1518

11. City of Calgary Parks Pathways

- Report work affecting multi-use pathways within and outside City road right-of-way.
- Multi-use pathway signage and pavement markings.

311

12. Alberta Transportation

Authorization for work on/or affecting provincial ROWs.

403-297-6311

Chapter 1 – Introduction

Purpose

The purpose of this manual is to set out standards and specifications for temporary traffic control in The City of Calgary designed for:

1. The safety of employees at the worksite.
2. The safety of all road users impacted by the temporary traffic control zone.
3. The protection of equipment used at the worksite.
4. Minimizing traffic disruption around the worksite and adjacent road network.

Scope

This manual is intended as a practical working reference to be used by private contractors, consultants, utility companies and City personnel. Uniform standards and procedures are set out in this manual and shall be adhered to when working on or adjacent to roadways under the jurisdiction of The City of Calgary.

All agencies and contractors shall observe and maintain these standards and procedures to ensure:

1. Uniform standards for design and quality of traffic control devices within The City of Calgary Right of Way (ROW).
2. Standardized procedure and placement of traffic control devices to minimize confusion for all users.
3. The promotion of uniform design and standards throughout Canada.

This manual shall be used in conjunction with the *Occupational Health and Safety Act* and *The Traffic Safety Act*, The Alberta Building Code, *Safety Codes Act* and associated regulations, all applicable bylaws and related contract documents.

Legal authority

All traffic signs, pavement markings, traffic control signals and other devices used for regulating, warning or guiding traffic are installed only under the authority, or delegated authority, of The City of Calgary. Work zone contractors and public utility companies may be permitted to install temporary conditions where they are designated by The City of Calgary. Work within Deerfoot Trail or Stoney Trail, including the west Calgary ring road and southwest Calgary ring road, ROW is provincial jurisdiction and requires approval from Alberta Transportation or its designate.

All work performed on City-owned ROW shall conform to the policies, standards and procedures set out by The City of Calgary including this Temporary Traffic Control Manual and the *Alberta Occupational Health and Safety Act*. The manager of the Traffic Division is appointed by Council under Bylaws 20M88 and 26M96 and by the Provincial Government under the *Traffic Safety Act*.

The Traffic Division manager is the final authority on temporary traffic control standards and sets the extent of traffic disruption allowed on all City-owned ROW. As such, the Traffic Division (311) must be notified before commencing work on, or adjacent to, all City-owned ROW.

Chapter 2 – Before you work on City ROW

Temporary traffic control plan

The following flow chart identifies the temporary traffic control plan requirements based on Road Classification and the posted speed of roadway. The roadway classification map can be referenced on page 3: this map defines the various roadway classifications. For the purpose of referencing between the below flow chart and the roadway classification map only, industrial arterial, urban boulevard, neighbourhood boulevard and parkway classifications presented in the map are considered under the arterial ≤ 60 km/h category in the flow chart unless the speed limit dictates otherwise. Please refer to the most recently available roadway classification map. The terms presented in the flow chart are defined below:

Single lane closure: Impacting only a single lane of traffic.

Multiple lane closure: Impacting more than one lane of traffic. i.e two-way traffic, full road closure, flagging.

Submit TCP (Traffic Control Plan) using manual: Applicant must submit TCP to traffic for approval referencing, TTC (Temporary Traffic Control) manual and obtain a street use permit.

Use traffic manual: Must obtain a street use permit or have a city wide annual street use permit. If transit stop is impacted, notify traffic.

Site specific TCP – authentication required: Applicant must submit site specific authenticated TCP to the Traffic Division for approval and obtain a street use permit. Authenticated TCP must follow standards issued by The Association of Professional Engineers and Geoscientists of Alberta.

Signalized intersection: Work impacting the operations of the traffic signal and/or its approaches.

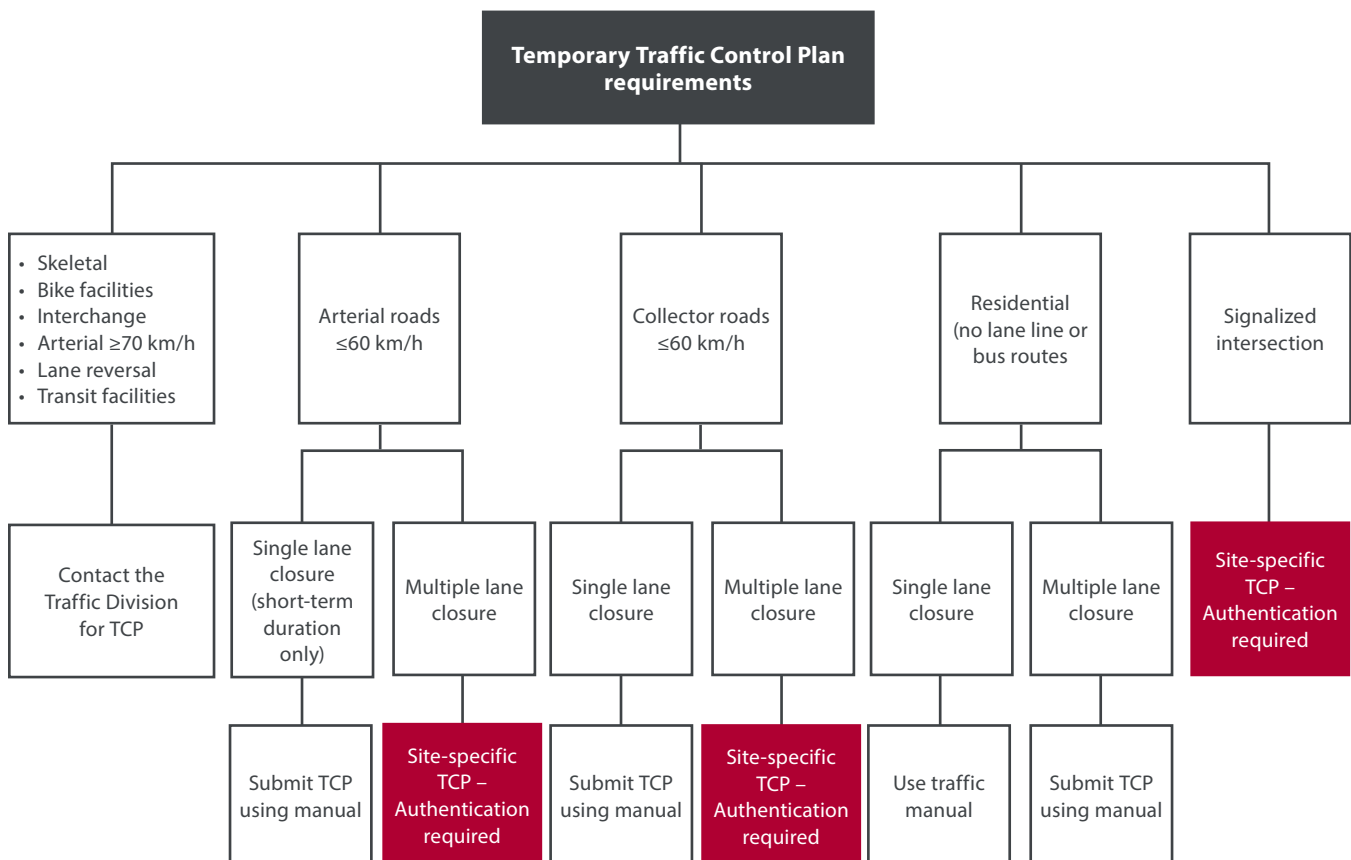

City of Calgary roadway classification map

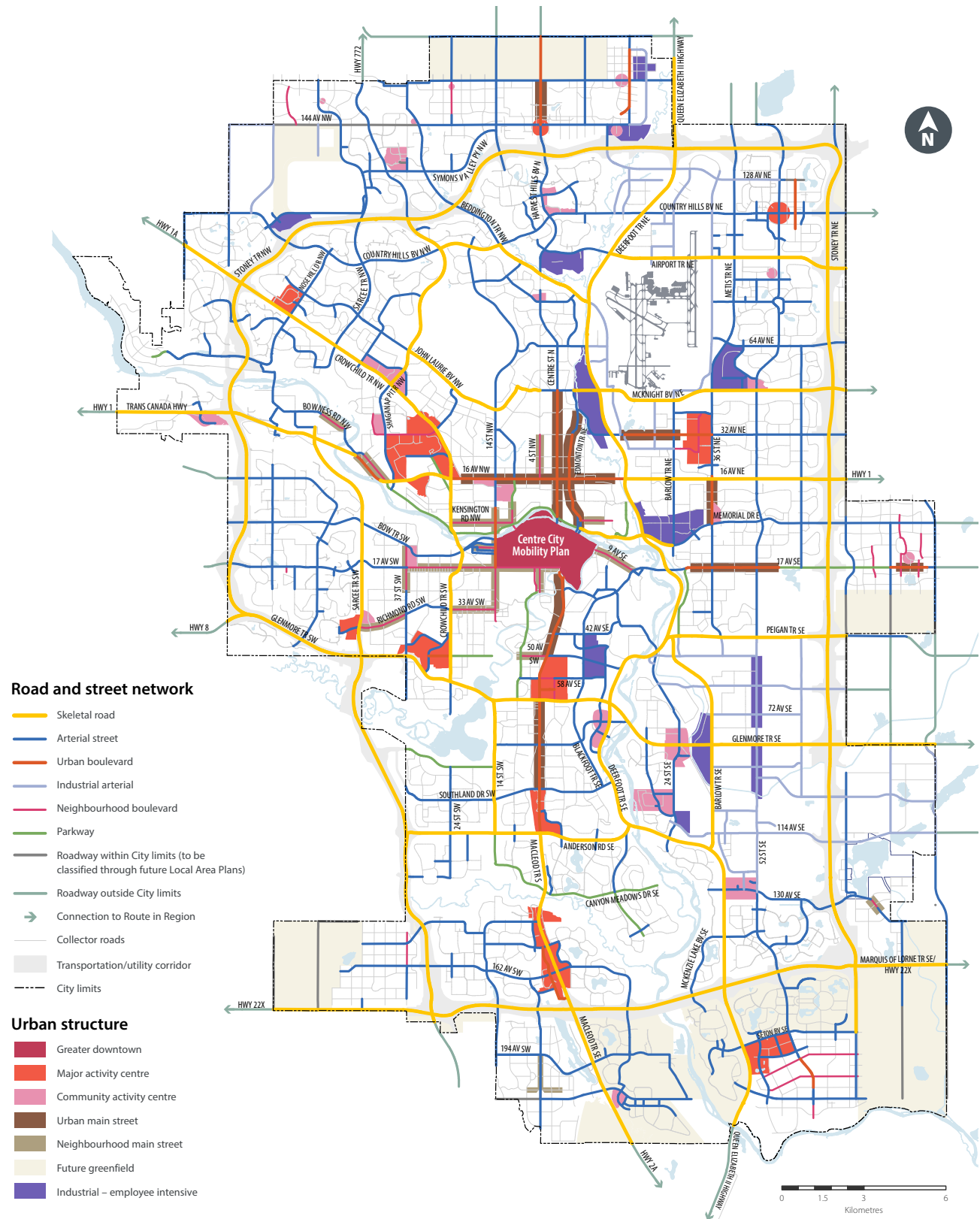

Road and street network

- Skeletal road
- Arterial street
- Urban boulevard
- Industrial arterial
- Neighbourhood boulevard
- Parkway
- Roadway within City limits (to be classified through future Local Area Plans)
- Roadway outside City limits
- ➔ Connection to Route in Region
- Collector roads
- Transportation/utility corridor
- City limits

Urban structure

- Greater downtown
- Major activity centre
- Community activity centre
- Urban main street
- Neighbourhood main street
- Future greenfield
- Industrial – employee intensive

Worksite assessment and checklist

Required permits/authorization

All work on City-owned ROW requires authorization and applicable permit(s). For information on required authorization and permits, contact Traffic Engineering by calling 311.

Before the job

1. Has Traffic approved your temporary control plan?
2. Do you need Traffic Division to provide your temporary traffic control?
3. Do you have the necessary permits (Street Use Permit, Hoarding Permit, Excavation Permit, Indemnification Agreement, etc.)? Refer to Appendix A and Appendix B for Street Use Permit and Hoarding Permit application requirements, respectively.
4. Is a tree protection plan required? (Contact Parks, Urban Forestry section at 311.)
5. Do you require a temporary no parking permit?
6. If you are working on a bus route, Bus Rapid Transit (BRT) right-of-way or Light Rail Transit (LRT) right-of-way, notify the Traffic Division so they can coordinate with Calgary Transit.
7. Have you given adequate advance notice to impacted businesses, utilities and residents (by means of a letter drop)? Has this letter been approved by the Traffic Division?
8. Are the proper temporary traffic control devices available at the worksite to accommodate traffic?
9. Are the pedestrians and motorists properly separated and protected from each other and the worksite?
10. Access for emergency vehicles shall be maintained at all times. Have you done everything to ensure emergency access?
11. Do you have a Record of Temporary Traffic Control form? Please refer to Appendix C.
12. Have you contacted the Canadian National Institute for the Blind (CNIB) if closing a sidewalk adjacent to collector or major roadways?
13. Are you removing any street lights? Temporary street lights (protocol). Contact The City of Calgary Traffic Street Lighting group by contacting 311.
14. Are you working at or near a traffic signal. If so, you may be impacting loops/camera detection. Contact The City of Calgary Signals group by contacting 311.

Refer to the appendices for further requirements and information.

Note: A reminder to contractors that any work within Deerfoot Trail or Stoney Trail, including the west Calgary ring road and southwest Calgary ring road, ROW is provincial jurisdiction and requires approval from Alberta Transportation

During the job

1. Is there enough proper equipment available to secure the worksite overnight if necessary? Remember, you will need reflective signs, markers, flashers and sandbags for your set-up. You may also need bridging materials, snow fence and barricades for the worksite. Are there any signs that need to be covered or removed during periods of inactivity (i.e., speed reduction signs)?
2. Are all temporary traffic control devices still in their proper places, aligned and standing upright? Do you need to secure signs with sandbags? Are the signs clean and legible (day and night)?
3. If a traffic control person is being used, are proper procedures being followed? Has the traffic control person(s) been trained by an accredited institution?
4. Does the traffic set-up continue to meet the needs of your job? If not, seek approval from the Traffic Division to modify and make changes.
5. Is the work zone being monitored, and are proper records collected using the form in Appendix C as specified?
6. Do you have an approved contingency plan in place to accommodate peak hour traffic if there is the possibility that the work may run into the peak hour?
7. Have arrangements been made for paving materials to bring the ROW back into service?

After the job

1. Have you obtained approval from the Traffic Division to re-open the roadway?
2. Have you cleaned up the worksite and rehabilitated the ROW in a condition equal to or better than it was prior to the start of the work?
3. Have arrangements been made to restore or rehabilitate the ROW?
4. Have you removed all temporary traffic control devices?

Restricted areas

Heavy rail ROWs (CN, CP)

All work that encroaches upon either the Canadian National (CN) or the Canadian Pacific (CP) rail ROWs shall be co-ordinated through the associated company. For approval and requirements regarding temporary traffic control, contact CN at 800-665-5662 and CP at 403-319-7000.

Light rail transit (LRT) ROWs

Traffic flow at any rail crossing is determined by the rail signals. Do not attempt to control movement of any LRT vehicles, except in an emergency.

These basic rules shall be followed when working on all LRT ROWs:

1. All necessary traffic lanes shall be closed before traffic enters the crossing. Traffic shall never be moved from one lane to another while crossing LRT ROWs.
2. Posting of traffic control persons is necessary whenever traffic is diverted across the centre line of the rail crossing. In this case the rail crossing arm does not extend far enough to stop the diverted traffic before entering the crossing.
3. Posting of traffic control persons may be necessary if motorists do not observe the stop lines at the LRT crossing.
4. Do not stop or park vehicles in LRT ROWs.
5. No traffic control devices are to be used on LRT ROWs.
6. Do not stockpile materials on LRT ROWs.
7. If you are experiencing difficulty, do not hesitate to contact Calgary Transit and/or the Traffic Division.

Calgary Transit shall be notified 48 hours in advance of work performed at or near an LRT crossing. Contact Calgary Transit Rail Control at 403-268-1518 to co-ordinate the necessary authorization and the required permits.

Seventh Avenue transit corridor

This area requires a special permit be obtained before proceeding with work. Contact Calgary Transit (311) to obtain the necessary permit. Traffic Division will supply and install all the necessary traffic control measures.

Traffic Division will instruct the foreman or supervisor on site as to maintaining this set-up.

All recommendations made by Calgary Transit shall be implemented. Calgary Transit will determine the type of traffic controls required and will set the extent of disruption allowed.

Provincial ROWs

For work located in or impacting the Deerfoot Trail and Stoney Trail, including the west Calgary ring road and southwest Calgary ring road, ROWs, phone Alberta Transportation 403-297-6311 and ask for the Operations Engineer. Note: In cases where lane closures and work are within the Deerfoot Trail ROW and Stoney Trail ROW, two weeks lead time will be required in order to obtain a permit.

Stephen Avenue Mall/Barclay malls

The City of Calgary and the Calgary Downtown Association have entered into a Management and Operating Agreement for the Stephen Avenue Mall and Barclay Mall. The Calgary Downtown Association is responsible for issuing parking and access permits, as well as permission for the use of the malls for patio, vending cart and busker purposes. For information regarding the above, please call the Calgary Downtown Association at 403-215-1570.

All other permits or permission for the use of the malls shall be obtained from The City. Contact the Traffic Division at 311.

Accreditation and Personal Protective Equipment

Alberta Temporary Traffic Control accreditation

It is recommended that all persons designing temporary traffic controls (TTCs) should be accredited by an appropriate agency. Accreditation will assist all parties involved in understanding and implementing temporary traffic control practices and procedures for construction worksites in the province of Alberta. For information regarding the Alberta Temporary Traffic Control Course, please contact the Alberta Construction Safety Association at (1-800-661-6090) or <http://www.acsa-safety.org>.

Traffic Control Person (flagperson) Accreditation

Any individual who will be acting as a traffic control person shall be properly trained in flagging. The Alberta Construction Safety Association offers a course to standardize traffic control training for the construction industry in Alberta. For additional information regarding this course, please contact the Alberta Construction Safety Association at (1-800-661-6090) or <http://www.acsa-safety.org>. A flag person is not authorized to control traffic at or near a traffic signal, a Calgary Police Services pay duty officer must be hired .

Alberta Temporary Traffic Control – Field Applications Accreditation

It is recommended that all persons involved in the implementation of TTC plans should be accredited by an appropriate agency. Again, the Alberta Construction Safety Association offers a course for those who are actively involved with the field implementation of temporary traffic control plans.

Personal Protective Equipment (PPE)

The City requires a minimum Class 2 vest, with higher levels as needed based on job site hazard assessment. Information regarding PPE is included, with the permission of the Canadian Standards Association (CSA), in Appendix D. To contact the CSA, visit csa.ca online.

Chapter 3 – Performance guidelines

Pedestrian and cyclist safety

The safety of pedestrians, cyclists and motorists must be considered in the design, set-up and operation of a temporary traffic control situation.

1. Pedestrian, cyclist and vehicular traffic must be physically separated.
2. Pedestrian and cyclist traffic must be physically separated from workers and equipment in the work area. Accommodations must be made for a safe passage through or around the work area.

This may require the use of barricades to separate the worksite from the walkway. It may be necessary to use bridges (complete with handrails) and sheltered walkways. In all cases, measures taken to protect the pedestrians are subject to approval by the Manager, Traffic.
3. A pedestrian detour route must provide a safe, continuous, accessible and convenient route with a smooth hard surface and accessible features consistent with the affected facility. Detectable warnings are required at temporary asphalt pedestrian curb ramps.

It is important to consider the wide-ranging needs of pedestrians. When necessary, all pedestrian detours need to be wheelchair accessible, with the inclusion of temporary ramps that have a firm, stable and non-slip surface. In addition, all barriers, signs and other obstructions must be detectable via a cane. No obstructions should protrude into the walk zone (at or below head height).

Best practice guidelines should be referred to for the provision of accessible ramps and pedestrian channelizing devices. Key principles are paraphrased below, for additional guidance refer to the document, *Applying the Americans with Disabilities Act in Work Zones: A Practitioners Guide*.

Pedestrian channelizing devices should have continuous bottom and top surfaces that share a common vertical plane and provide colour contrast. The lower edge of the bottom surface should be no higher than 2 inches (5 cm) above the walkway and the top edge of the bottom portion should be at least 8 inches (20 cm) above the walkway to promote detection for users of long canes or with low vision. The top of the top surface should be smooth to promote hand-trailing and be no lower than 32 inches (81.5 cm) above the walkway.

Curb ramps should ideally not be steeper than 8%. Colour contrasting marked edges of 2 inches (5 cm) height should be provided where a vertical drop of 3 inches (7.5 cm) or greater or a side apron slope of 33% or greater is in place. A landing at a maximum 2% slope dimensioning 48x48 inches (1.2x1.2 m) should be provided at the top and bottom of the curb ramps.

4. Depending on the balance of vehicle to pedestrian traffic, a parking or travel lane adjacent to the work site can be used to provide a temporary pedestrian detour, provided that the route is clearly defined and adequately separated from traffic. A pedestrian detour route must provide a safe, continuous, accessible and convenient route with a smooth hard surface and accessible features consistent with the affected facility. Detectable warnings are required at temporary asphalt pedestrian curb ramps.
5. Complete sidewalk or pathway closures that force pedestrians to use the other side of the street should only be done as a last resort. If it is necessary to direct pedestrians to the other side of the road, signage must be placed in advance of the intersections closest to either end of the construction zone. This will allow pedestrians to cross at the intersection, prior to entering the construction zone. Additional barricades and signage should also be placed directly adjacent to the work area, to reinforce that the sidewalk is closed in the work zone.
6. All full sidewalk closures must be approved by the Traffic Division.

Note: Signs should be clear of all pedestrian facilities (sidewalks) to maintain mobility

Standards of performance and responsibility

With the exception of emergency related work, all work on City-owned ROW shall:

1. Be approved by the Traffic Division under authority of the manager. They will set the extent of traffic disruption allowed. They will determine temporary traffic control necessary for the work proposed.
2. Be pre-authorized and reported to the Traffic Division seven business days in advance of expected start date. Traffic Engineering (311) is located in Manchester Building E.
3. Require authorization and/or a special permit when working in restricted areas.
4. Require an Excavation Permit from Roadway Maintenance division (Manchester Building E) before the excavation is started.
5. Require a Building or Demolition Permit from Development & Building Approvals (Municipal Building) before building or demolition is started.

In the case of emergency related work, contact the Traffic Division before work is started. Phone 101 Dispatch at 311. Notify Tri-Services at 311 (911 for life threatening situations) of the location of any detour or diversion on any arterials, skeletal, expressways or freeways. Always use qualified traffic control persons or City police to supplement an incomplete set-up under these circumstances.

In all cases:

Plan

1. Minimum lane width shall be 3 metres per lane. On roadways with fire or bus routes, a minimum width of 3.3 metres shall be maintained. Subject to approval by the Traffic Division, an authenticated engineering drawing is required to modify travel lane width.
2. In the city centre or other areas of high pedestrian volume, the minimum sidewalk width shall be 2 metres. In other parts of the city, the minimum sidewalk width shall be 1.5 metres. This width shall be increased if there is a likelihood of people using mobility aids or heavy pedestrian traffic. The path of travel shall be free from obstructions for the full width of the walk to a minimum height of 2.4 metres. This minimum width must be unobstructed and not impede the path of pedestrians.
3. Minimum bike lane width shall be 1.2 metres per lane. This width shall be increased under such circumstances as curves, heavy truck traffic or high-speed situations. Path of travel shall be free from obstructions for the full width of the lane to a minimum height of 2.5 metres.
4. Minimum multi-use pathway width shall be 2.0 metres clear width with no obstructions or encroachments. This width shall be increased in the event of a high likelihood of people using mobility aids or heavy pedestrian and cyclist traffic. Path of travel shall be free from obstructions for the full width of the pathway to a minimum height of 2.5 metres. Approval by Parks & Pathways.
5. Sidewalks shall be maintained smooth and free of tripping hazards. Functional drainage and adequate lighting shall be provided.
6. Channelized pedestrian detours in the city centre or high-pedestrian traffic areas (transit stops/stations) shall be illuminated for 24-hour use.
7. Multi-use pathways shall be smooth, free of tripping hazards and provide positive drainage.
8. Limit site access across the pedestrian route to controlled points and maintain the pedestrian route surface at the site access driveways (remove tracked earth, gravel, mud) to provide a smooth surface for pedestrians.

9. Street closures and/or detours may be preferable to using complicated traffic set-ups or traffic control persons. Approval shall be obtained from the Traffic Division four working days in advance of expected start date.
10. Obtain a temporary no parking permit and No Parking zones to be established require four working days advance notice. The requesting party or Traffic (under contract) shall place No Parking signs 12 to 24 hours prior to commencing work. Time/date decals are required on No Parking signs. In either case, the requesting party is responsible for sign maintenance. Parking control personnel will check the No Parking zone 12 hours in advance of the prescheduled work to ensure sufficient signing. This zone will only be enforced provided there is sufficient signage and adequate advanced notice.
11. Rush hour traffic in the city is typically from 6 to 9 a.m. and from 3 to 6 p.m., Monday to Friday. During these times, construction is not allowed on arterials, skeletal, expressways or freeways, except in cases of emergency or with prior approval of Traffic.
12. When traffic lanes within the worksite are required to be open to travel (i.e., during rush hours or at the end of a shift), trenches and small excavation sites may be bridged with steel plates. This should be used only if backfilling all or part of a trench is not practical. Bridging must meet City of Calgary standards and specifications. Traffic must be notified and an authenticated engineering drawing submitted for steel plates.

Communicate

1. Any disruption that may affect pathway operations outside of The City road right-of-way shall be co-ordinated with the Parks Pathway co-ordinator (311). Pathway detours within the road right-of-way shall be co-ordinated with the Parks Pathway co-ordinator and the Traffic Division.
2. Any disruption that may affect on-street bicycle route, cycle track operations shall be co-ordinated with the Traffic Division.
3. It's the responsibility of the permit holder to notify affected residents/businesses of road closures, parking restrictions and other work that impacts normal traffic flow. The recommended method to notify the public of parking restrictions is by advanced signage, resident/business letters and starbust boards.
4. Calgary Transit must be notified of work affecting a bus route or bus stops. For a traffic detour, notify Calgary Transit at least two full working days in advance. Traffic can assist in work affecting transit routes/stops. Avoid delaying transit operations whenever possible. If a problem arises, please contact Traffic.
5. Waste & Recycling Services (311) shall be notified 24 hours in advance of laneway or street closures affecting garbage pickup for longer than one day. Notify Waste & Recycling Services immediately of emergency work affecting garbage pickup.
6. The Traffic Division shall be notified if a permanent traffic sign has to be removed. This should be reported at the same time as approval for traffic set-up is sought. Traffic shall place a portable sign to replace the permanent sign. The permanent sign must be removed and replaced by Traffic.
7. Any disruption that may affect signal timing, signal display or signal operations shall be co-ordinated with the Traffic Division. In the event of a signal related emergency, contact the Traffic Management Centre at 311.

Implement

1. All necessary traffic control devices must be in place before work commences. These devices shall be maintained by the permit holder/contractor for the duration of work/temporary traffic control while any obstruction to traffic exists. These devices shall remain in place for the duration of work.
2. Store vehicles and equipment outside of the pedestrian route.
3. All temporary traffic control set-ups shall be to the satisfaction of the Traffic Division. The set-up shall be maintained satisfactory at all times until normal conditions are restored.
4. Contracting departments or agencies shall ensure that private contractors and other agencies working for them, maintain City of Calgary procedures and standards. Traffic may inspect any worksite at any time, and recommendations made by the Traffic shall be implemented.
5. The restoration of road surfaces, sidewalks and boulevards must be to the satisfaction of the Operational Services business unit.
6. Occasionally, an emergency vehicle (e.g., police cruiser, ambulance, fire truck) will approach the traffic control zone with sirens and lights flashing. Worksite employees are responsible for ensuring that traffic is stopped by accepted traffic control methods, so the emergency vehicle may safely drive through the zone.

Securing the worksite

Securing the worksite is necessary to protect the public from potential hazardous conditions within the work zone. It's necessary to secure the worksite when work is taking place, and during any periods of inactivity.

Some examples of inactivity are shutdowns due to weather conditions, end of shift, weekends, holidays and lunch/coffee breaks. The necessary steps to secure the worksite are outlined below:

During periods of activity

1. Ensure that all temporary traffic control devices are legible and properly positioned.
2. All devices must be retro-reflective.
3. Remove or securely cover any signs that are not required or are conflicting. For example, cover the gazette speed if the set-up requires a speed reduction.
4. Place barricades around all stockpiled material, soil piles and equipment that is stored on the road or the shoulder.
5. All temporary traffic control devices shall be properly secured.
6. Inspect the worksite as required and keep record of inspection. See Appendix C.
7. Once secured, drive and walk the worksite to ensure that the traffic control set-up provides motorists, cyclists and pedestrians with adequate advance warning, and provides positive guidance around the worksite. Ensure that safe, convenient and accessible pedestrian and cyclist movement is maintained, and pedestrian and vehicle movements are separated.
8. Arrange to have sidewalks and multi-use pathways within the traffic control zone cleared of snow, ice and debris. If required, sand during periods of icy conditions.

During periods of inactivity

1. Where possible, remove all equipment and materials from the roadway.
2. Establish a barrier around open excavations using physical barriers, such as concrete safety shaped barriers, suitable fencing, etc. The location and the nature of the excavation will dictate the method used to provide the necessary safety required.
3. Place barricades around all stockpiled material, soil piles and equipment that is stored on the road or the shoulder.
4. Retro-reflective chevrons or flashers shall be used to delineate the tapers. Flashers shall be used to separate the travel lane(s) and the worksite. They shall also be used to identify material and equipment storage on the road or the shoulder. Traffic Field Operations does not supply flashers with their temporary traffic control set-ups. It is therefore the responsibility of the permit holder to supply and maintain these.
5. All traffic control devices shall be secured during periods of inactivity.
6. Arrange to have roads within the traffic control zone sanded during periods of icy conditions.
7. Remove or cover any signage that is not required.
8. Inspect the worksite as required and keep a record of the inspections. See Appendix C.
9. Arrange to have sidewalks and multi-use pathways within the traffic control zone cleared of snow, ice and debris. If required, sand during periods of icy conditions.

Once secured, drive and walk the worksite to ensure that the traffic control set-up provides motorists, cyclists and pedestrians with adequate advance warning and provides positive guidance around the worksite. Ensure that safe, convenient and accessible pedestrian and cyclist movement is maintained and pedestrian and vehicle movements are separated.

Bridging

When steel plate bridging is required on city streets, the Traffic Division must be notified and an authenticated engineering drawing must be submitted prior to installing the steel plates/bridging. The following standards shall be maintained:

- Contact the Traffic Division to determine the necessary set-up required (for example, plating may require a speed reduction).
- Bump signs shall be provided for each traffic direction.
- All bridge edges must be smoothed out or feathered using hot or cold mix asphalt.
- All bridge plates must be adequately pinned to the road surface to prevent bridge movement.
- Temporary hazard markers shall be used to mark the location of bridging plates.
- Insulate the plates to prevent banging; especially in the vicinity of residential communities.
- Define/highlight the edges of the plating with high visibility material, such as fluorescent orange paint.

Installation, maintenance, record keeping and removal

Installation

All devices shall be placed in a manner so as not to interfere with existing applicable traffic control devices. It's important to survey the site before preparing a temporary traffic control plan. This ensures any conflicting signs are covered or removed. For example, if a speed reduction is required, the gazetted signs shall be covered or removed. Contact Traffic Division.

Maintenance

It is important to maintain all temporary traffic control devices. Some examples of maintenance include, but are not limited to:

- Cleaning all signs and devices.
- Ensuring all signs and devices are located as per plan.
- Ensuring all signs and devices are secured for adverse conditions.
- Cleanliness and operation of flashing lights for night use.

Record keeping

Record keeping is an important component of temporary traffic control to document and ensure the appropriate measures are in place at all times. The project supervisor is responsible for maintaining a record of the temporary traffic control used and taking the necessary steps to correct any deficiencies. This may include contacting Traffic, other providers of traffic control or, in the case where the contractor has been given the authority to provide its own traffic control, correcting the deficiency. A Record of Temporary Traffic Control is provided as a sample form for the purpose of record keeping. See Figure 1.

Figure 1: Record of Temporary Traffic Control

Record of Temporary Traffic Control (Inspection Form)

Site location			Work order/Street use permit			
Work order			Contact name			
Phone number			Company			
Inspected by						
Date/ Time	Type of Setup	Setup as per plan (Y/N)	Deficiencies (List)	Photo Taken (Y/N)	Traffic Signal Observation/ Traffic Impact	Action items

RLCA – Right lane closed ahead
 LLCA – Left lane closed ahead
 2RLCA – Right lanes closed ahead
 2LLCA – Left lanes closed ahead
 TWT or 2WT – Two way traffic
 SWC – Sidewalk closed
 HRDING – Hoarding Permit

NPAT – No parking anytime
 NTT – No through traffic
 LTO – Local traffic only
 RC – Road closed
 RCLA BD – Right lane closed ahead both directions
 LLCA BD – Left lane closed ahead both directions

Removal

Upon completion of work, the restoration of road surfaces, sidewalks and boulevards must satisfy the conditions of the excavation permit process (contact the excavation permit office). Removal of temporary work zone traffic control requires planning to identify procedures, order of removal and potential assistance for take-down such as shadow vehicles.

Chapter 4 – Guidelines for traffic control

Fundamentals for application

Temporary workzone component areas

A typical temporary traffic control set-up comprises of the entire length of the road from the first advance warning sign to the last traffic control device that returns vehicles to its normal conditions. A temporary traffic control setup can be divided into four distinct component areas as shown on Figure 2.

1. Advance warning area

This area is used to inform road users of the upcoming work zone and what action to take. The number traffic control devices in the advance warning area shall account for the required downstream conditions in the work zone such as reduced speeds, lane closures, etc. The spacing and number of devices is to allow for sufficient distance for drivers to interpret and react before reaching the work area.

2. Transition area

This area is used to move the road users out of the normal path such as lane closure(s) or shoulder work that may encroach into the adjacent travel lane and marks the location where delineation devices are typically introduced. The intended path must be clearly delineated so drivers do not follow the wrong path. It is important to note that vehicle parking, equipment or material storage should not be placed in the transition area.

3. Activity area

This is the area where the work takes place and contains the longitudinal and lateral buffer spaces, work space and traffic space.

The longitudinal buffer space provides protection for traffic and workers between the transition area and work space. This buffer space provides a recovery area for errant vehicles and should be free from parked vehicles, equipment or material storage.

The lateral buffer space provides separation between the traffic space and the work space. Engineering judgement should be applied for the lateral buffer space with consideration of speed, traffic volume, lane width, vehicle classification, time of day and work duration.

The work space is provided for workers, equipment and material storage. Measures should be considered to minimize hazards and distractions to road users and workers.

The traffic space allows traffic to pass through the activity area. Minimum lane widths of 3 m shall be maintained (3.3 m for fire and bus routes). Consideration of the lane geometry, off-tracking and shy offset distances should be made in the provision of lane widths.

4. Termination area

This area is used to allow the road users to return to their normal path. The area extends from the end of the work space to where traffic returns to its intended path of travel.

Figure 2: Components of a temporary Traffic Control Zone

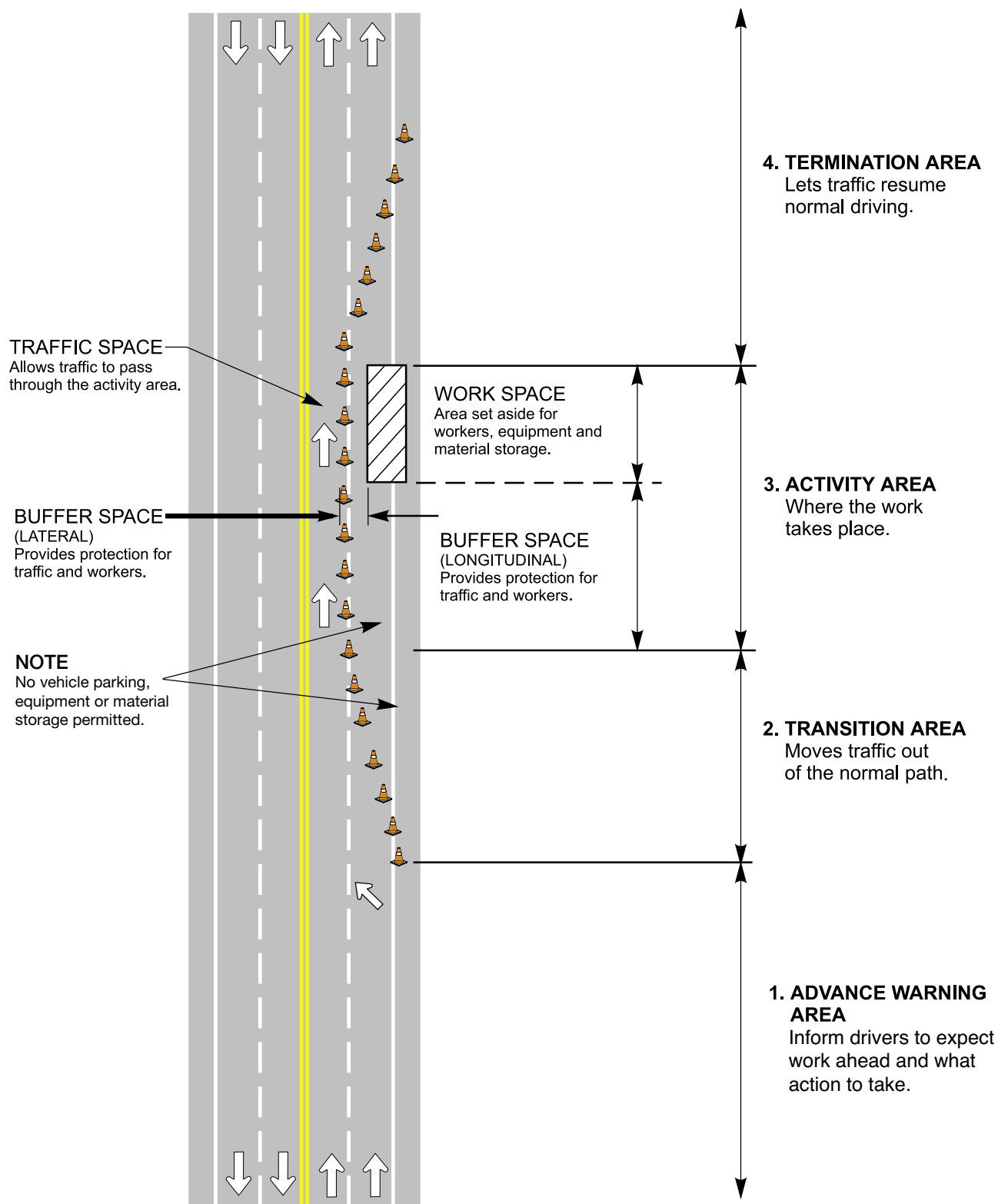

Basic temporary traffic control tapers and tangent criteria

The purpose for different taper types and other accompanying longitudinal elements is described in the following figure and table. Longitudinal distances for tapers, tangents between tapers, buffers and run-in-length on centerline differ based on the speed as described in the section following.



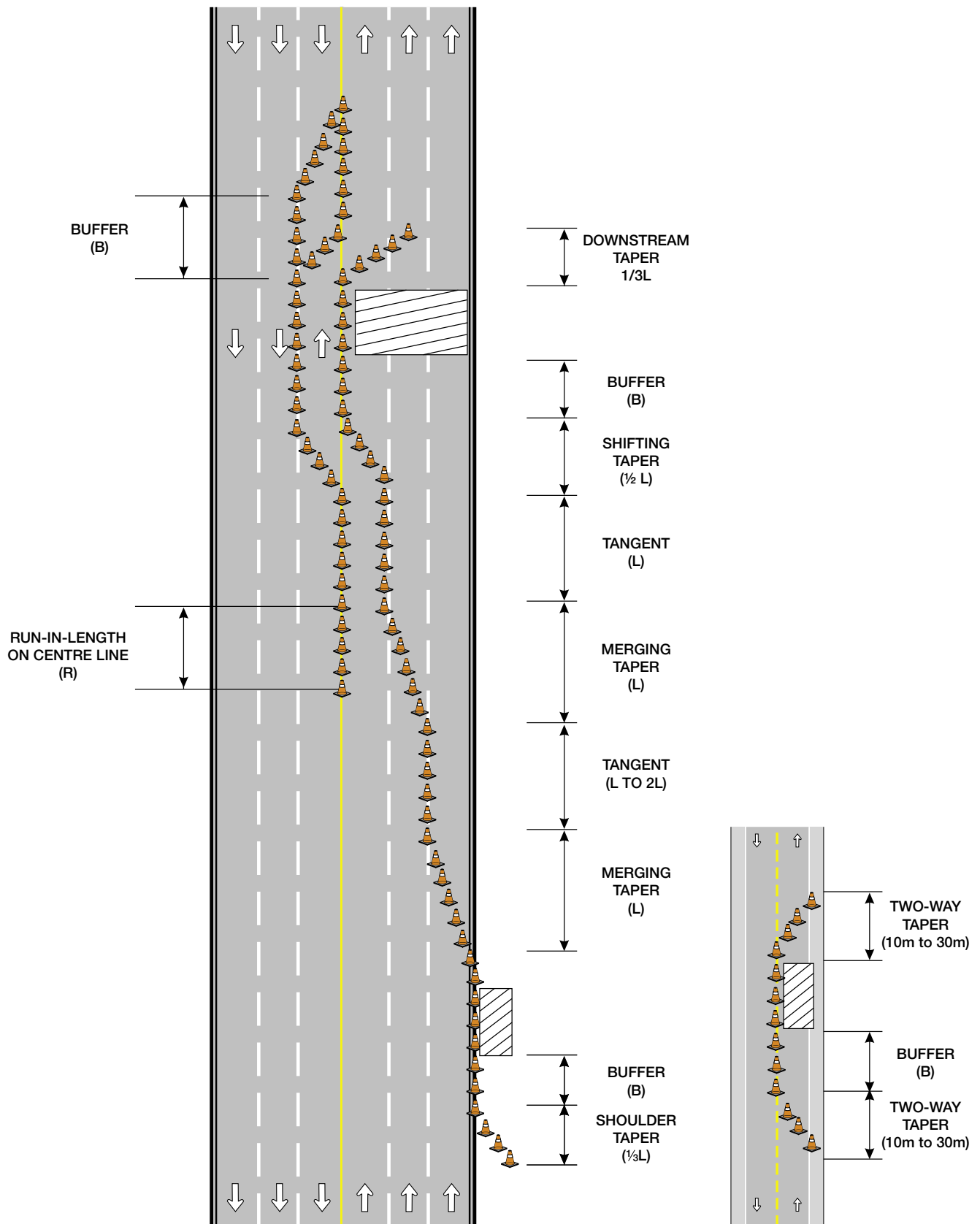

TAPERS	
DESCRIPTION	LENGTH
<p>Merging taper Where a lane closure taper is utilized to join traffic from a closing travel lane to an adjacent travel lane.</p>	L (min)
<p>Shifting taper Where a travel lane is shifted laterally by up to one lane width where drivers simply follow a path of travel and are not required to merge or diverge with adjacent travel lanes.</p>	L/2 (min)
<p>Shoulder taper Where a shoulder is closed to provide a work space on the shoulder for activity or storage. Shoulder tapers may be considered for full-time parking lanes; judgement should be exercised for part-time parking lanes where a merging taper may be more applicable.</p>	L/3 (min)
<p>Two-way taper Where a taper is utilized to close a travel lane for a work area along a two-way roadway and the remaining portion facilitates alternating traffic in each direction.</p>	10 m – 30 m
<p>Downstream taper Where a transition is provided within the termination area from the end of the activity area to where the normal path of travel is provided.</p>	L/3 (min)
TANGENTS	
DESCRIPTION	LENGTH
<p>Merge followed by merge The parallel distance between the end of one merge taper and the start of another merge taper. A minimum length of one merge taper length should be provided although twice the merge length may be considered for high speed or high volume roadways.</p>	L (min) 2L (desirable)
<p>Merge followed by shifting taper The parallel distance between the end of one merge taper and the start of a shifting taper. A minimum length of one merge taper length should be provided to allow the driver to observe and react to traffic control devices between consecutive maneuvers.</p>	L (min)
<p>Buffer Provides a recovery area for an errant vehicle by separating road users and work areas (or other road users where utilized between opposing traffic directions).</p>	B
<p>Run-in-length on centreline Utilized on the centerline as a tangent length before a lane shift or end of a merge.</p>	R

Figure 3: Taper types

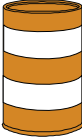

Traffic control devices – Length and spacing guidelines

The following table outlines guidelines for the length and spacing of traffic control devices as described in this section.

V (km/h)	A (m)	L (m)	B (m)	D (m)	R (m)	N		
30	25	10	20	6	30	5		
40	25	20	30	6	30			
50	50	30	35	8	40	5		
60	50	40	45	12	50			
70	75	60	50	15	65	8		
80	100	80	60	15	65			
90	100	105	65	18	80			
100	125	125	70	18	80			
110	125	145	75	20	90			

Where: **V** = Normal posted regulatory speed limit

A = Spacing between signs

L = Length of taper

B = Length of longitudinal buffer space

D = Spacing between delineation devices

R = Run-in-length on centre line

N = Number of delineation devices per taper

Note for speed limits effective May 31, 2021, the default unposted speed limit within city limits was changed to 40 km/h per The City of Calgary Standard Speed Limit Bylaw.

The sign/delineator spacings and taper/buffer lengths presented in this manual are based on the 2014 Transportation Association of Canada (TAC) Manual of Uniform Traffic Control Devices for Canada (MUTCDC): Fifth Edition. It is recognized that the sixth edition of the MUTCDC is anticipated to present values for these items which differ from the fifth edition. The following are rationale for the spacing and lengths presented as guidelines in this manual:

- **Sign spacing (A)**

The sign spacing from the 2014 MUTCDC has been maintained to allow for consistent setups in constrained urban environments. Note that the sixth edition of the MUTCDC presents an A1 value for signs warning of hazard/decision points versus an A value for information signs. The designer should exercise engineering judgement for the situation at hand where the application of alternate and greater sign spacings may provide drivers more distance to conduct maneuvers such as stopping or changing lanes.

- **Delineator spacing (D)**

The delineator spacing from the 2014 MUTCDC has been maintained to allow for consistent setups in urban environments. Note that the sixth edition of the MUTCDC presents different delineator spacings for along tapers/curves/adjacent to hazards versus tangents/areas not adjacent to hazards. The designer should again exercise judgement where delineator spacings could be modified in circumstances that may enhance conspicuity and clarity for drivers.

- **Taper length (L)**

The taper length from the 2014 MUTCDC has been maintained to allow tapers to be consistently applied in constrained in urban environments. The taper length in the 2014 MUTCDC accounts for the braking distance of an errant vehicle and is less than what the taper length accounts for in the sixth edition of the MUTCDC which is based on stopping sight distance for low speed roadways. Similar to other design elements, the designer should exercise judgement where alternate taper lengths may be beneficial for certain applications.

- **Buffer length (B)**

The buffer length from the 2014 MUTCDC has been maintained to allow for consistent setups in urban environments. The buffer length in the 2014 MUTCDC accounts for the brake reaction distance of 2.5 seconds perception/reaction time while the sixth edition of the MUTCDC equates the longitudinal buffer length to the braking distance of an errant vehicle (what is applied for L, above).

Following the 2014 MUTCDC, the summation of L and B equates to stopping sight distance. As identified by TAC, taper lengths should be compromised as a last resort; where needed, the buffer space may be reduced or eliminated after alternatives such as relocating the taper has been considered and identified as impractical. In these instances, additional advance warning or delineation devices should be considered.

Based on a review of current practices in other jurisdictions, the following items have also been presented as guidelines for applications in the City of Calgary:

- **Run-in-length on centre line (R)**

The sixth edition of the MUTCDC presents a run-in length on the centreline where an adjacent travel lane merges into the travel lane adjacent to the centerline. The length is defined by $0.8 \times$ the normal posted speed limit and is measured upstream from the end of the merging taper. For consistency in field setups, this value has been rounded and grouped for certain speed limits for simplicity.

- **Number of delineators on taper (N)**

A minimum number of delineation devices on tapers are presented to ensure the conspicuity of tapers by ensuring a sufficient number of delineation devices are provided. Although the number varies among jurisdictions, the values identified have been presented to maintain consistency in field setups.

Duration of work

Mobile

- Mobile operations are those that are typically performed on the move at low speed and may require periodic stopping for only a few minutes.
- Examples of mobile operations are: street sweeping, longitudinal pavement marking, watering of trees and hydro-seeding.

Very short duration

- Very short duration operations are those that can be completed in 30 minutes or less and may be stationary or mobile with frequent short stops.
- Examples of very short duration operations are: minor utility and roadwork, crack sealing, bus shelter washing, catch basin cleanout, pothole patching/repair, symbol and transverse road marking, minor sign maintenance, signal light replacement and emergency response (e.g., spills and vehicular accidents).

Short duration

- Short duration operations are stationary and range between 30 minutes and 24 hours.
- Examples of short duration operations are: maintenance, sidewalk/boulevard repair, utility work, asphalt patching, emergency water-main repairs and emergency response (e.g., spills and vehicular accidents).

Long duration

- Long duration operations are stationary and take longer than 24 hours.
- Examples of long duration operations are: manhole replacement, utility replacement, bridge rehabilitation, roadway upgrading (e.g., interchange construction), large paving operations and sidewalk/boulevard replacement.

Traffic control devices and measures

Signs and specifications

Below is a listing of common temporary traffic control signs. The sign sizes shown in the below list represent the minimum sizes as identified by TAC MUTCDC or The City of Calgary Sign Code Manual. Increases in sign sizes beyond the minimum is required in consideration of the normal posted speed limit, implications of the hazard, available space for signage and the existing roadway environment (roadway classification, competition from other signs, lighting, parking). Temporary signs should meet the requirements of standard sized signs applied in permanent signage applications so temporary signs do not de-emphasize the importance of standard sized signs or contrariwise.

The sign sizes shown in the below list and additional signs in Appendix E have been provided for reference purposes as the existing roadway environment must be considered. The table shown in Appendix E provides preliminary guidance for determining potential sign sizes for temporary conditions with three primary sign sizes and custom sized signs reserved for special circumstances:

- Regular – Typically applied for speed limits of 50 km/h or less
- Large – Typically applied for speed limits of 60 km/h or more
- Oversized – May be considered where oversized signs would respect the surrounding roadway environment
- Custom – Special reduced sign sizes in constrained locations

For other signs, sizes and types commonly used in the city of Calgary, please refer to The City of Calgary Sign Code Manual. Contact Traffic Engineering to obtain information on the Sign Code Manual.

Double signage, with one on each side of a divided roadway, should be provided where conditions permit, especially on roadways of 60 km/h or greater speed limit. All signs, unless otherwise specified, must be retro-reflective. High intensity material (Reflectivity Level 1) is the City standard.

Legend

Sign name (MUTCDC Code) (City of Calgary Sign Code Manual Code)

- Sign description
- Sign size (presented are minimum size per TAC or regular size per Appendix E – refer to references for additional guidance)
- Colour information

Regulatory signs

Regulatory signs are used to identify a traffic regulation that is applicable at a given time or place on a road and to identify the legal requirements. The following codes are used to categorize the various regulatory signs as below:

RA: Right-of-way control signs

RB: Road use control signs

RC: Miscellaneous regulatory signs



Stop sign (RA-1) (11-001)

- This sign indicates to drivers that they must come to a complete stop and must not proceed until it is safe to do so.
- 600 mm x 600 mm.
- White text and border on red background.



Multi-way Stop tab (RA-1S4) (11-008)

- This sign indicates there are more than two approaches controlled by stop signs.
- 400 mm x 250 mm.
- White text and border on red background.



Yield sign (RA-2) (11-002)

- This sign indicates that drivers must yield the ROW, stop if necessary and must not proceed until it is safe to do so.
- 600 mm height.
- Red symbol and border on white background.



Maximum Speed sign (RB-1) (41-0X0)

- This sign indicates the maximum legal speed.
- 450 mm x 600 mm
- Black text and border on white background.



Maximum Speed Ahead sign (WB-9 modified) (13-065)

- This sign provides advance warning of a speed reduction.
- 450 mm x 600 mm.
- Black text and border on yellow background.



Double Fine Area sign (19-031)

- This sign advises motorists that speed fines double in the work area.
- 750 mm x 750 mm.
- Black text and border on a white background.



Start/End of Double Fine Area signs (RB-80S1/RB-80S2) (19-033/19-032)

- These signs identify where the double fine area starts and ends.
- 750 mm x 450 mm.
- White text on a black background.
- Refer to Page 37, speed fine doubles application.





**Left/Right Turn Prohibited sign (RB-11R and RB11L)
(11-806 right prohibited; 11-804 left prohibited) (left shown)**

- This sign indicates that a right or left turn is prohibited.
- 600 mm x 600 mm.
- Black arrow and border, with red circle and bar on white background.



Entry Prohibited sign (RB-23) (11-240)

- This sign indicates that access to vehicular traffic is not permitted.
- 600 mm x 600 mm.
- Black border, red symbol on white background.

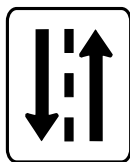

Two-way Traffic sign (RB-24) (11-789)

- This sign indicates that the section of road is a two-way road.
- 450 mm x 600 mm.
- Black symbol and border on white background.

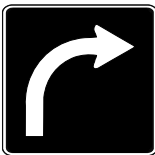

**Right (Left) Turn Only Lane sign (RB-41R and RB41L modified)
(11-645 left; 11-646 right)**

- Used on approach to an intersection, this sign indicates to drivers that they must turn from the designated lane at the intersection.
- 900 mm x 900 mm.
- White arrow and border on black background.



Parking Control sign (RB-51) (03-003)

- This sign indicates that parking is prohibited at all times on all days and on both sides of the sign. Various prohibitions to times, duration and coverage area can be specified.
- 300 mm x 300 mm.
- Black symbol and arrows with red circle and bar, and black border on white background.



Stopping Prohibited sign (RB-55) (04-003)

- This sign indicates that stopping is prohibited at all times on all days and on both sides of the sign. Various prohibitions to times, duration and coverage area can be specified.
- 300 mm x 300 mm.
- Black symbol and arrows with red circle and bar, and black border on white background.



Stop Line sign (RC-4) (11-800 left, 11-801 right)

- This sign indicates the point where drivers approaching a traffic control device must stop their vehicles; especially at locations where the stop line is non-standard or the stopping location may not be obvious.
- 450 mm x 600 mm.
- Black text, symbol and border on white background.

Temporary condition signs

Temporary condition signs are used for temporary traffic control and have an orange background with black symbol or text.



Sidewalk Closed sign (19-034)

- This sign indicates that the sidewalk is closed.
- 600 mm x 450 mm.
- Black text and border on white background with black symbol.



Construction Ahead sign (TC-1) (19-010)

- This sign indicates advance warning of a major work zone and are generally used for long-term construction projects.
- 750 mm x 750 mm.
- Black text, symbol and border on an orange background.



Road Work sign (TC-2) (19-016)

- This sign indicates that activities, such as minor maintenance or utility operations, are in progress on or adjacent to the road.
- 750 mm x 750 mm.
- Black symbol and border on an orange background.



Construction Ends sign (TC-4) (19-012)

- This sign indicates the end of the workzone.
- 750 mm x 750 mm.
- Black text and border on an orange background.



Temporary Lane Closed Ahead sign (TC-5) (19-027 left; 19-028 right)

- This sign indicates that a lane is closed ahead.
- 750 mm x 750 mm.
- Black symbol and border on an orange background.



Lane Closure Arrow sign (TC-7 modified)

- This sign indicates that traffic must proceed to the left or right of the closed lane.
- 600 mm x 450 mm.
- Black symbol and border on an orange background.



Detour Ahead sign (TC-10) (19-009)

- This sign indicates that traffic will be required to take another road to bypass the temporary road blockage.
- 750 mm x 750 mm.
- Black text, symbol and border on an orange background.



Detour Direction Markers (TC-11) (19-001 to 19-007)

- These signs indicate the alternate route to take as a result of a total road closure.
- 600 mm x 450 mm.
- Black text, symbol and border on an orange background.



Through Traffic Prohibited sign (19-014)

- This sign indicates a worksite ahead, but allows for local traffic up to the worksite.
- 600 mm x 600 mm.
- Black text and border on an orange background.



Road Closed sign (19-307)

- This sign indicates that access is prohibited to all traffic.
- 900 mm x 450 mm.
- Black text and border on an orange background.



Local Traffic Only sign (19-308)

- This sign indicates that local traffic is permitted.
- 900 mm x 450 mm.
- Black text and border on an orange background.



Road Diversion sign (TC13R and TC13L)(19-077)

- This sign indicates a deviation from the normal road.
- 750 mm x 750 mm.
- Black symbol and border on an orange background.



Road Realignment sign (TC-15)

- This sign indicates the road is realigned from normal.
- 600 mm x 600 mm.
- Black symbol and border on an orange background.



Road Closed Ahead sign (TC-88)

- The road closed advisory sign provides advance notice of a complete road closure or closure of a direction of travel ahead.
- 750 mm x 750 mm.
- Black text and border on an orange background.



Ramp Closed sign (TC-66)

- This sign is used when a ramp is temporarily closed.
- 750 mm x 750 mm.
- Black text and border on orange background.



Temporary Remote Control Device Ahead sign (TC-82)

- The Temporary Remote Control Device Ahead sign is used to provide advanced warning of a temporary traffic signal.
- 750 mm x 750 mm.
- Black symbol with red, yellow and green signal on an orange background.



Shared Lane sign (TC-73) (19-788)

- This sign is to be used where there is a need to warn motorists to watch for bicyclists traveling along the road.
- 600 mm x 600 mm.
- Black symbol and border on an orange background.



Lane Realignment sign (TC-16)

- This sign indicates the realignment of two lanes. If more than two lanes are realigned, a custom sign is required.
- 750 mm x 750 mm.
- Black symbol and border on an orange background.



Traffic Control Person Ahead sign (TC-21) (19-020)

- This sign indicates that traffic is controlled by a traffic control person.
- 600 mm x 600 mm.
- Black symbol and border on an orange background.



Be Prepared To Stop sign (19-021)

- This sign indicates that the motorist may be required to stop.
- 750 mm x 750 mm.
- Black text and border on an orange background.



Yield to Oncoming Traffic sign (19-036)

- This sign indicates that a condition of yield to oncoming traffic is ahead.
- 750 mm x- 750 mm.
- Black text and border on an orange background.



Chevron Alignment sign (TC-31) (19-043 right; 19-042 left)

- This sign indicates a change in the horizontal alignment of the road.
- 450 mm x 600 mm.
- Black symbol and border on an orange background.



Double Object Marker sign (WB-36) (13-429)

- This sign indicates an obstruction in the road which can be passed on either side.
- 450 mm x 600 mm.
- Black symbols and border on an yellow background.



Road Narrows sign (TC-34) (19-029)

- This sign indicates the narrowing of the road.
- 750 mm x 750 mm.
- Black symbol and border on an orange background.



Grooved Pavement sign (TC-47) (19-048)

- This sign indicates that the road surface requires attention by motorcycle or bicycle operators.
- 750 mm x 750 mm.
- Black symbol and border on an orange background.



Single-File sign (TC-72) (19-788)

- Bicycles may be used on roadways where no bicycle lanes or adjacent shoulders usable by bicyclists are present and where travel lanes are too narrow for bicyclists and motor vehicles to operate side by side.
- 600 mm x 600 mm.
- Black symbol and border on an orange background.



Pavement Drop-off sign (TC-49) (19-049)

- This sign indicates that on the approaching section of road, either or both the adjacent lane or shoulder are lower or higher than the driving lane.
- 750 mm x 750 mm.
- Black symbol and border on an orange background.



Bump sign (TC-51) (19-180)

- This sign warns of approaching bump in the road.
- 750 mm x 750 mm.
- Black symbol and border on an orange background.



Pavement Ends sign (TC-50)

- This sign indicates that the hard surface road is about to end.
- 750 mm x 750 mm.
- Black symbol and border on an orange background.



Low Clearance Ahead sign (TC-52)

- This sign indicates the maximum overhead clearance at bridges and other structures.
- 750 mm x 750 mm.
- Black dimension, arrows and border on an orange background.



Truck Entrance sign (TC-54) (19-050 left: 19-051 right)

- This sign indicates trucks entering the roadway.
- 750 mm x 750 mm.
- Black symbol and border on an orange background.



Construction marker (TC-62 modified) (19-209)

- This sign is used to separate the work area from the traffic area.
- 300 mm x 900 mm.
- Orange symbol on a black background.



Bicycle Lane Closed sign (TC-68) (19-400)

- This sign is used to warn cyclists that the bicycle lane is temporarily closed.
- 450 mm x 450 mm.
- Black symbol and border on an orange background.

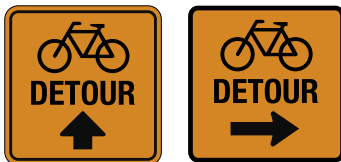

Bicycle Lane Detour markers (TC-70) (19-410 to 19-415)

- These signs are used to indicate an alternate route for cyclists to follow where zone activities require the total closure of a bicycle lane, and a signed detour route exclusively for bicycles is required.
- 450 mm x 450 mm each.
- Black symbol and border on an orange background.



Bicycle Lane Detour Ends markers (TC-71) (19-416)

- This sign is used to denote the end of a detour.
- 450 mm x 450 mm.
- Black symbol and border on an orange background.

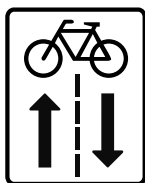

On Street Bicycle Route sign (special)

- This sign indicates that the section of road is a two-way road for cyclists.
- 300 mm x 450 mm.
- Black symbol and border on white background.



Except Bicycles sign (41-252)

- This sign indicates cyclists are only permitted.
- 450 mm x 300 mm.
- Black text and border on white background.

The following drawing shows an example of a typical portable sign stand.

Portable signs must be placed outside of the pedestrian and bicycle detour routes.

Figure 4: Typical portable sign stand

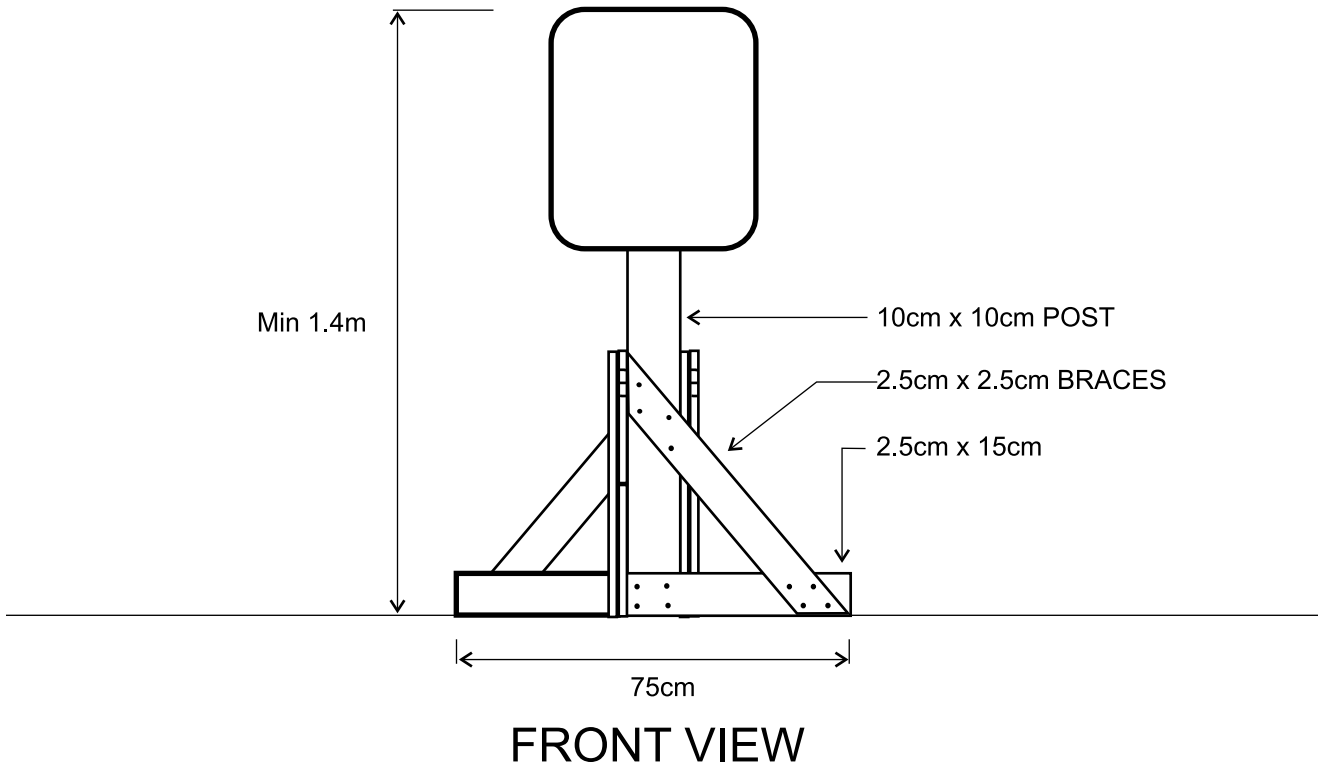

Control of traffic using a traffic control person

Traffic control persons are required:

1. When two-way traffic has to be guided through a single lane.
2. When materials or equipment are being moved across a sidewalk, multi-use pathway or travelled lane.
3. To assist pedestrians, cyclists and motorists through complex traffic control set-ups.
4. When required by the Traffic Division.

A traffic control person is responsible for the safety of motorists, cyclists, pedestrians, fellow workers and equipment used on the worksite. Workers in charge of traffic control must be selected based on the individual's experience, alertness and decisiveness. Traffic control persons shall be familiar with flagging standards and procedures as set out by the Alberta Construction Safety Association (ACSA). For more information on courses offered on flagging operations, please contact the ACSA at (1-800-661-6090) or visit <http://www.acsa-safety.org>.

A traffic control person is required to use a reflective Stop/Slow paddle as shown in figure 5. At night, a red lantern or flashlight must be used in addition to the paddle. the traffic control person must wear an approved hard hat (CSA Standard CAN/CSA Z96-15), eye protection, class three reflective coveralls (CSA Standard CAN/CSA Z96-15), and safety footwear with green triangle CSA marking as identified by "Part 18 Personal Protective Equipment" in the *Occupational Health and Safety Act*.

Illumination should be provided for traffic control persons required to be working in areas where normal street lighting is not available during hours of darkness. Always use a Traffic Control Person Ahead sign (TC-21) and a Be Prepared to Stop sign (19-036) in advance to alert motorists of a flagging operation. Traffic control persons shall stop traffic from the side of the traffic lane and shall never turn their back to traffic. Traffic control persons shall never leave their post until relieved by another traffic control person in full safety apparel.

Each traffic control person shall keep in visual contact with any other traffic control persons on the job. If visual contact cannot be maintained, there must be radio contact or a third traffic control person to relay signals. For example, a third traffic control person can relay signals from a position on the middle of a curve, or atop a hill (where visibility is obstructed by horizontal or vertical curves).

When more than one traffic control person is required at a non-signalized intersection, traffic shall be moved through the intersection one direction at a time. Use a predetermined clockwise or counter-clockwise rotation to accomplish this.

Traffic Control Person is not authorized to flag traffic at a signalized Intersection, contact Traffic to arrange for Pay Duty Officers. Certain situations may require the use of the Calgary Police Service (CPS). Contact the Traffic Division to discuss the need for police involvement and arrange for pay duty officers.

Figure 5: Traffic control paddles

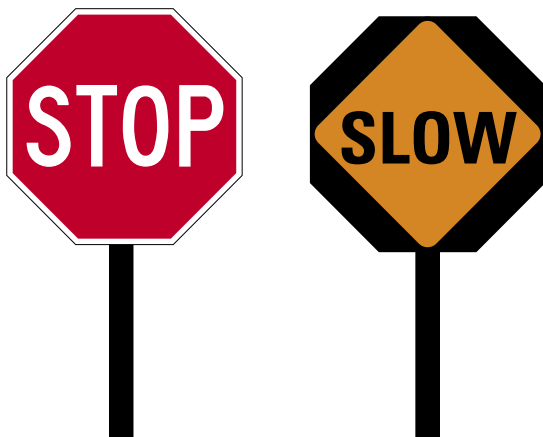

Delineation (channelization) devices

Delineation devices are used to form curves, lines or boundaries that guide motorized road users, cyclists and pedestrians to the intended path.

Delineation devices (such as barricades) **along pedestrian detour routes shall:**

1. Have continuous detectable edging at ground level for people with vision impairments.
2. Be continuous, stable and non-flexible (rigid).
3. Be placed continuously without gaps between sections.

Delineation devices include cones, construction markers, drums, tubular devices and chevron alignment signs. Delineation devices do not include barricades, concrete barriers or other types of signs.

Traffic cones shall be fluorescent orange and made of rubber or similar flexible material. The minimum height required for cones is 450 mm on roadways with a speed limit of 50 km/h or less, and 700 mm for speeds up to 60 km/h. For use on roadways where the speed is 70 km/h or greater, drums shall be used. Tubular markers may be used for tangent sections on roadways (70 km/h or greater) provided recommended spacing is adopted (refer to typical set-ups for required spacing).

Construction markers may be used for delineation devices; however, they are not recommended.

Drums for high volume/high speed roadways or cones for lower speed roadways are the preferred methods. Drums shall be constructed of a material that does not create a hazard to vehicles on impact and should be manufactured so as not to roll.

Retro reflective material, 100 mm in height, shall be affixed to traffic cones and drums, as show in Figure 6.

Chevron alignment signs may be used to provide additional guidance on the outside of curves or sharp turns. Amber flashers/warning lights shall be used to identify obstructions at night. There are three main types of lights for the purpose of temporary traffic control:

- a. Type A: Low intensity flashing lights for nighttime use.
- b. Type B: High intensity flashers are effective day and night.
- c. Type C: Steady burn, low-wattage lights are used at night for delineation.

Additional consideration should be given for nighttime work. Nighttime work can expedite the work, reducing the disruption of traffic. If floodlights are used for nighttime work, care should be taken so as not to impair the vision of approaching motorists.

Figure 6: Delineation devices

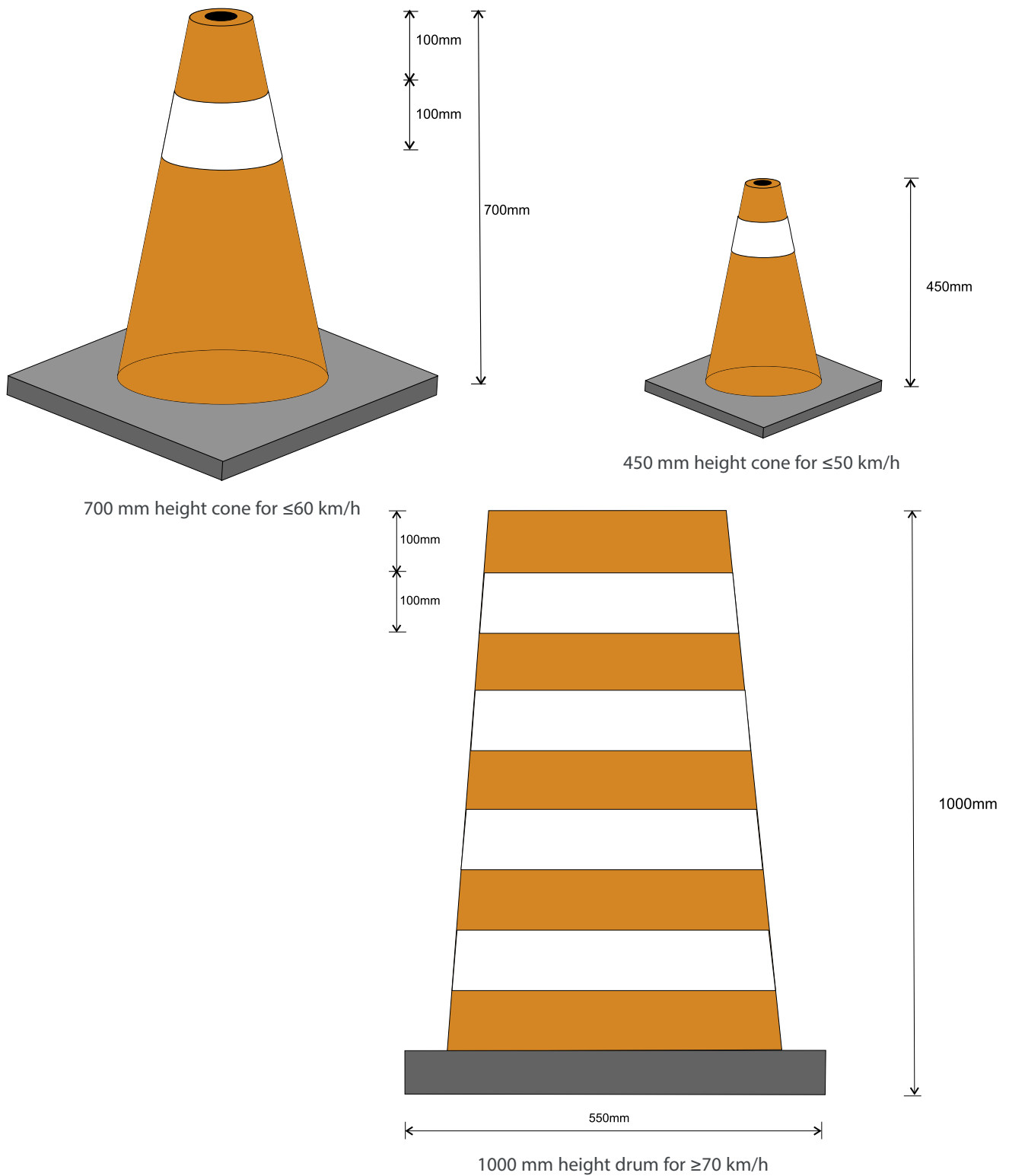

Barricades

Proper placement of barricades is necessary to ensure public safety. Barricades are a potential hazard. The following provides some examples of acceptable and non-acceptable use of barricades:

Barricades along pedestrian detour routes shall:

1. Have continuous detectable edging at ground level for people with vision impairments.
2. Be continuous, stable and non-flexible (rigid).
3. Be placed continuously without gaps between sections.

Acceptable use of barricades

- Barricades shall face oncoming vehicular traffic.
- Barricades are used to outline hazardous work areas and to prevent vehicles and pedestrians from entering the work area.
- Barricades are used to warn of an activity area and to obstruct entry into an activity area.
- Temporary signage may be placed on barricades only if necessary to accommodate modified Lane Closure arrow, Road Closed or No Through Traffic signs.
- Barricades shall be used to close a road.

Non-acceptable use of barricades

- Barricades shall **not** be used as a delineation device.
- Barricades shall **not** be placed parallel to the flow of traffic. (For example, they are not to be used to mark the boundary between a travel lane and the work area or separate adjacent lanes of traffic.)
- Barricades shall **not** be placed in oncoming traffic without necessary advance warning devices and signs.
- Barricades shall **not** be used instead of signposts.
- Barricades shall **not** be used for the placement of regulatory signs.
- Barricades shall **not** be located within the buffer area.

Light barricades

- A light barricade is a portable device that typically has one rail.
- Light barricades used along pedestrian routes must have continuous detectable edging at ground level for people with vision impairments. This edging can be provided in the form of a second rail at ground level.
- Light barricades may be used for road, street, lane or shoulder closures of short duration.
- Light barricades should be stabilized using sandbags placed on the lower section of the frame. Under no circumstances shall they be placed over the rail of the barricade.

Figure 7: Typical light barricade (temporary)

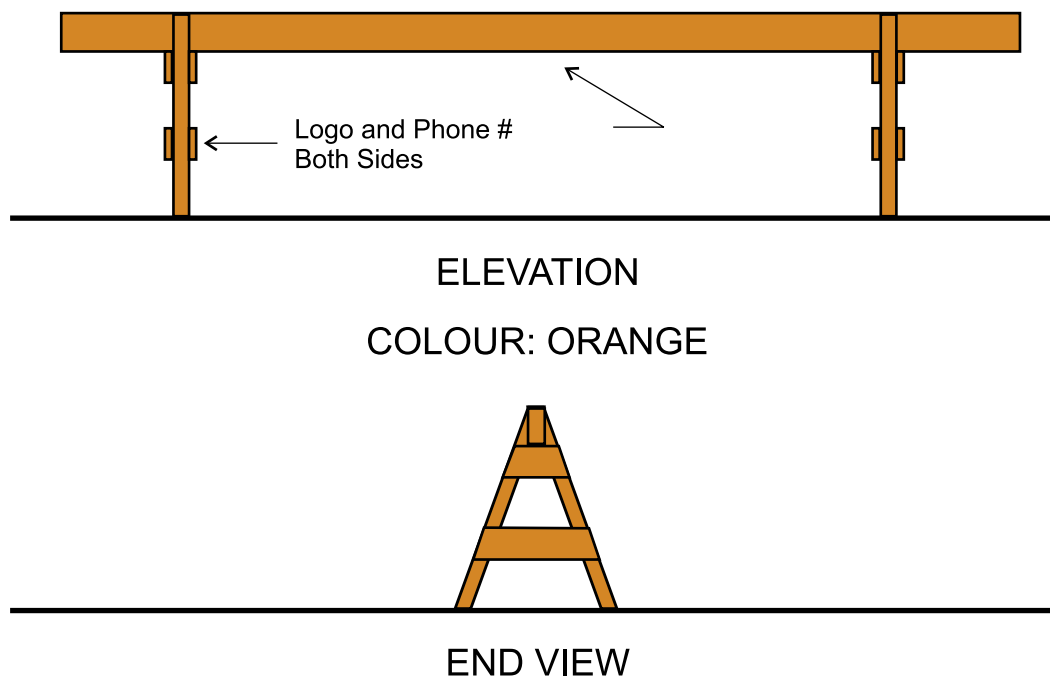

Traffic barriers

Longitudinal traffic barriers are used in work zones to:

- Limit the possibility of traffic entering the work area.
- Protect the workers.
- Separate traffic.
- Protect the construction site.
- Separate pedestrians from vehicular traffic.

Must submit an authenticated engineering drawing and obtain approval from traffic prior to installing traffic barriers on roads right-of-way. The use, placement and maintenance of longitudinal barriers should be based on acceptable engineering practices. Traffic barriers should:

- Be placed continuously without gaps between sections.
- Have acceptable flare rates on the leading edge or have appropriate end treatments (e.g., impact attenuators).
- Be equipped with glare screens where necessary.
- Be placed 0.6 m from the edge of the driving lane.
- Be used during periods of inactivity where excavations compromise public safety.

For information on temporary concrete barriers and acceptable barriers, refer to City of Calgary "Standard Specifications for Road Constructions".

For acceptable applications and installation requirements, please refer the current *Roadside Design Guide*, American Association of State Highway and Transportation Officials.

Arrow boards

Arrow boards are a safe and effective method of traffic control when used as intended. They are not to take the place of advance warning signs or delineation devices. When combined with the use of advance warning signs and delineation devices, arrow boards are very effective. They are especially useful in situations that require higher than normal visibility. It's important to note that arrow boards used for nighttime applications should be less bright than during daytime operations so as not to impair the vision of approaching motorists.

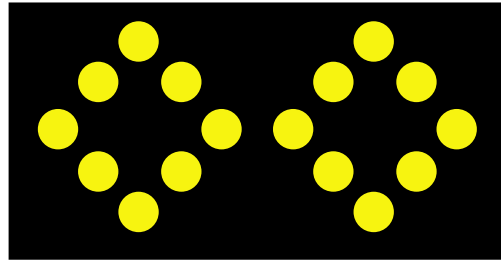
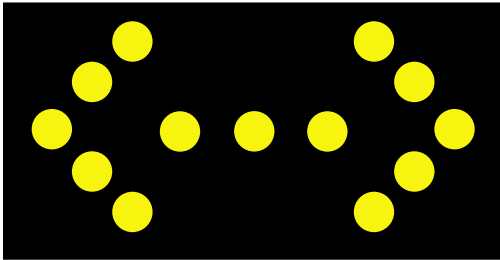
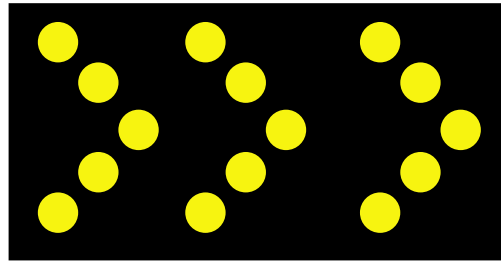
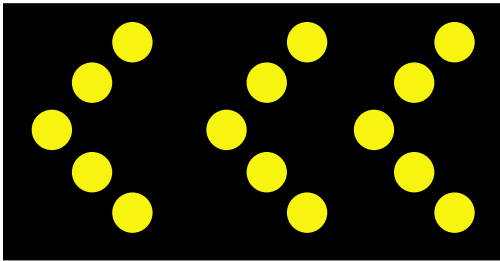

Variable message boards

Variable message boards (VMB) are typically used to provide road users with information of work zone conditions which are outside the road user expectation. Examples:

- To reiterate work zone speed limits where the speed of vehicular traffic is required to decrease.
- To advise when significant queuing and delays are expected.
- To warn of hazards or abnormal road conditions.
- To provide advance notification of ramp, lane or roadway closures.
- To inform road users of alternative routes.
- To assist with collision or incident management.

Messages on VMB typically communicate three pieces of information to the road user:

1. The problem (e.g., collision, lane closed),
2. The location (e.g., 200 metres, next exit), and
3. The action required (e.g., reduce speed, change lanes).

Placement and messaging of VMB must be approved by Traffic.



Impact attenuators

Impact attenuators (also known as crash cushions) are used to prevent an errant vehicle from impacting a fixed object by controlled deceleration. Impact attenuators in temporary traffic control zones protect the motorists from the exposed ends of barriers, fixed objects and other hazards. There are two types of attenuators commonly used for temporary traffic control: (1) stationary, and (2) truck mounted (or mobile). Truck mounted attenuators (TMAs) are mounted on the rear of a crash truck and deform on impact in a controlled manner.

Stationary attenuators are recommended for long-term situations, while TMAs are preferable for short-term or mobile operations. For more information on the use and types of these devices, refer to the current *Roadside Design Guide*, American Association of State Highway and Transportation Officials. An engineer authenticated drawing is required for the use of crash attenuators.

Intelligent Transportation Systems (ITS)

Intelligent transportation systems can improve the safety of the workers and the motorists, and reduce driver frustration through work zones. There are many products available to assist in achieving these goals. Below are some examples of ITS and some typical applications:

- **Over height vehicle detection systems**
These could be used in situations where bridge maintenance requires falsework, thereby reducing the normal clearance of a bridge. These systems typically use sensors to identify approaching over height vehicles and alert drivers of the restricted clearance. If possible, the alert to drivers should be provided at or before a decision point so drivers can divert to an alternative route.
- **Workzone intrusion sensors/alarms**
These systems are used to prevent crashes and injuries in workzones by alerting both the workers and the errant vehicle drivers of an intrusion into the workzone.
- **Advance Travellers Information System (ATIS)**
These can be used to inform drivers of expected delays, caution drivers to reduce speed, advise motorists of closures and provide information on alternate routes.
- **Dynamic workzone systems**
These systems promote smooth traffic flow leading into a workzone by creating a dynamic no passing zone upstream of the workzone. ITS monitoring systems detect speed and volume to adapt the length of the zone to changing traffic conditions. The dynamic system deters vehicles from attempting to get ahead in the line by changing lanes at the last possible opportunity.

These systems are just a few examples of intelligent information systems that are available for use for temporary traffic control.

Speed fines double

An amendment to Alberta's *Traffic Safety Act* was made to encourage motorists to adhere to the speed limit in active work areas. Active work areas must be kept as short as possible and only extend where actually needed to improve speed limit compliance.

If used, the active work area Speed Fines Double sign and Begins sign must be set up below or immediately in front of the Maximum Speed sign. The double fine area will terminate at the Speed Fines Double and Ends signs.

The Speed Fines Double, Begins and Ends signs must be used to mark the extent of active work areas in high speed situations (70 km/h or greater). Active work areas with lower speeds, such as residential areas, may not have these signs. In addition, work areas set up for five days or more must receive Speed Fines Double, Begins and Ends signs, but areas set up for temporary work may not receive the signs.

Speed Fines Double, Begins and Ends signs must be covered or removed when workers are not present. No double fines will be issued during these times. Motorists can be issued double fines regardless of whether or not Speed Fines Double signs are installed, provided that workers are present or it is anticipated that workers will be present, as it is an active work area. (See Section 7.7 in *AT TAWZ Guide*, 2018).





A construction zone can be composed of more than one active work area. In this situation, more than one double fine area may exist within a given construction zone. In this case, the extent of each double fine area will coincide with Maximum Speed signage used to mark the extent of each active work area.

Chapter 5 – Temporary traffic control (typical applications)

This chapter deals with how signs and devices are used for temporary conditions. Since they cannot cover all site-specific conditions, the examples provided here are labelled as typical applications. These typical applications provide the user with the minimum requirements for temporary traffic control. Signs and devices must be placed outside of the pedestrian and bicycle routes, such as sidewalks and multi-use pathways.

Annual city-wide permit holders are only authorized to perform setups shown in drawing index number: 1) roadside work, 2) mobiles, 3) single lane closure and 9) sidewalk closures.

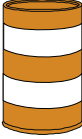
Please refer to the following table for minimum temporary traffic control length and spacing guidelines as presented in this Chapter’s drawings and defined in Chapter 4, page 19.

V (km/h)	A (m)	L (m)	B (m)	D (m)	R (m)	N		
30	25	10	20	6	30	5		
40	25	20	30	6	30			
50	50	30	35	8	40	5		
60	50	40	45	12	50			
70	75	60	50	15	65	8		
80	100	80	60	15	65			
90	100	105	65	18	80			
100	125	125	70	18	80			
110	125	145	75	20	90			

Where: **V** = Normal posted regulatory speed limit
A = Spacing between signs
L = Length of taper
B = Length of longitudinal buffer space

D = Spacing between delineation devices
R = Run-in-length on centre line
N = Number of delineation devices per taper

Drawing index

- 1. Roadside work**
 - 1.1. Work adjacent to a roadway 40
 - 1.2. Shoulder work 42
 - 1.3. Work on edge of roadway 44
- 2. Mobiles**
 - 2.1. Moving jobs 46
 - 2.2. Mobile operations on residential 48
 - 2.3. Mobile operations on collector or arterial (v≤60km/h)..... 50
 - 2.4. Mobile shoulder work..... 52
- 3. Single lane closure**
 - 3.1. Yield to oncoming traffic 54
 - 3.2. Single right lane closure 56
 - 3.3. Single left lane closure 58
 - 3.4. Speed reduction with right lane closure 60

4. Flagging operations	
4.1. Automated flagger operation.....	62
4.2. Two-way flagging operation.....	64
5. Multi-lane closures	
5.1. Two right lanes.....	66
5.2. Two left lanes.....	68
5.3. Left lane closed in each direction.....	70
5.4. Shoulder detour.....	72
5.5. Road diversion two directions.....	74
6. Crossovers	
6.1. Centre line crossover two-way traffic.....	76
6.2. Median crossover two-way traffic.....	78
6.3. Two-way left-turn lane closed.....	80
7. Intersections	
7.1. Intersection work – Example 1.....	82
7.2. Intersection work – Example 2.....	84
7.3. Intersection work – Example 3.....	86
7.4. Intersection work – Example 4.....	88
7.5. Intersection work – Example 5.....	90
7.6. Intersection work – Example 6.....	92
7.7. Intersection work – Example 7.....	94
8. Road closures	
8.1. Back lane closure.....	96
8.2. Road closure.....	98
8.3. Cul-de-sac closure.....	100
9. Sidewalks	
9.1. Sidewalk closure – Midblock (active site).....	102
9.2. Sidewalk closure – One-way midblock (idle site).....	104
9.3. Sidewalk work – Intersection corner (active site).....	106
9.4. Sidewalk work – Intersection corner (idle site).....	108
9.5. Sidewalk work – Right lane closure.....	110
9.6. Sidewalk work – Partial sidewalk closure.....	112
10. Road bridging.....	114
11. Cycle track closure, Bike lane, Shared use bike lane, Roundabouts, Lane reversal, Airport tunnel, Interchanges	116
Contact Traffic	

1.1 Work adjacent to a roadway

1. Example shown

Two-lane – two-way street without shoulder (residential).

No encroachment onto road.

2. Conditions

Worksite must be in the boulevard area, completely off the road.

Excavations require protection.

3. Observations

Note use of advance warning sign.

4. Set-up procedure

Set up advance warning sign and then cones.

Commence work.

1.1 Work adjacent to a roadway

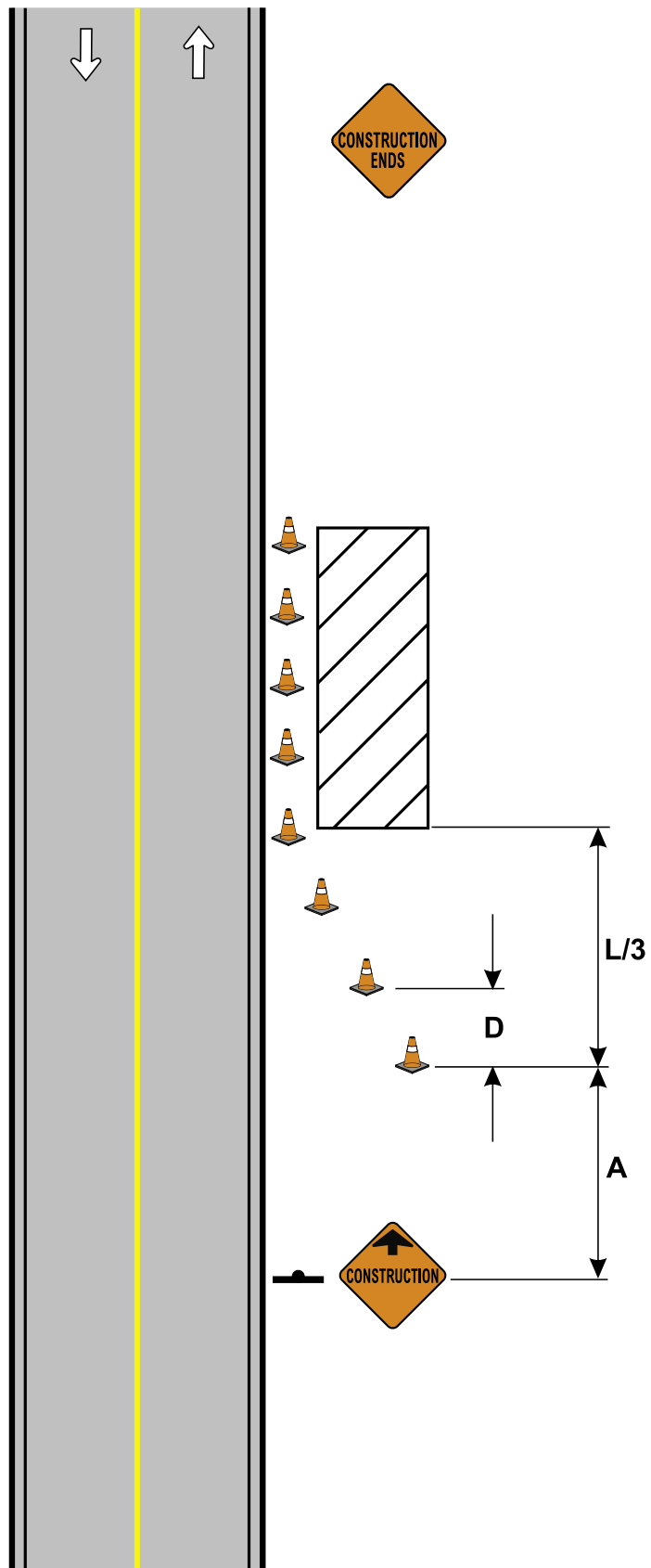

Note:
This drawing is a graphical representation of the detour set-up. It is **not** drawn to scale.

1.2 Shoulder work

1. Example shown

Two-lane – two-way street with parking lane/shoulder.

No encroachment in lane.

2. Conditions

Approaching traffic must be able to pass by worksite while remaining completely within their own lane.

3. Observations

Applies to sidewalk or curb and gutter repairs.

4. Set-up procedure

Set up advance warning sign.

Set up Lane Closure Arrow sign.

Set up taper and outline worksite with cones.

Commence work.

1.2 Shoulder work

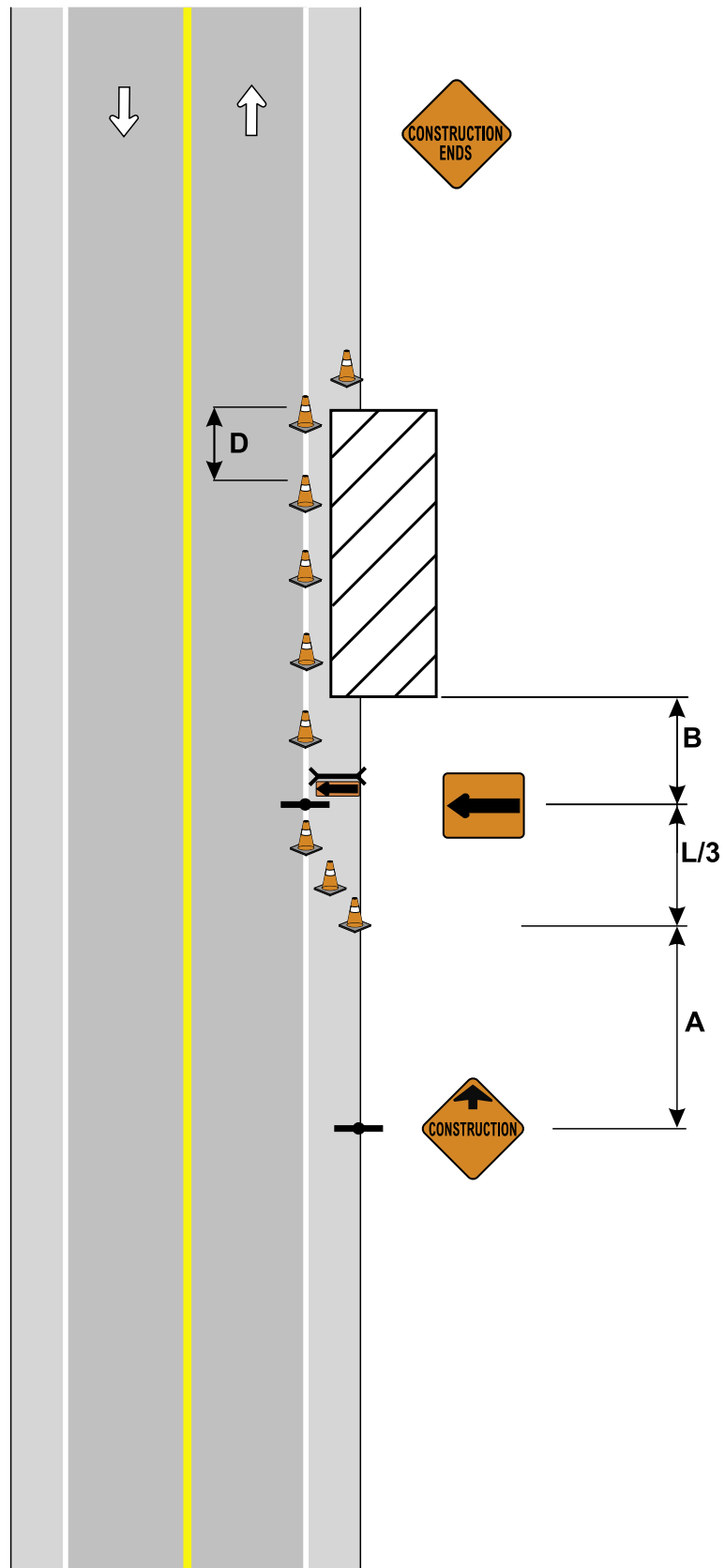

Note:
This drawing is a graphical representation of the detour set-up. It is **not** drawn to scale.

1.3 Work on edge of roadway

Note: Two-way traffic signs must face both directions of travel.

1. Example shown

Two-lane – two-way street parking lane.

Encroachment in right lane.

2. Conditions

Approaching traffic must be partially diverted into oncoming traffic.

3. Observations

Two lanes of 3 metre minimum width must be available, bus routes require minimum of 3.3 m width. If this condition cannot be met, refer to two-way flagging operation.

4. Set-up procedure

Set up No Parking zone first and have it inspected by the Calgary Parking Authority 12 hours prior to restriction.

Start at top of diagram. Set up advance warning signs for southbound lane in order shown.

Set up cones and two-way traffic signs separating the two lanes.

Start at bottom of diagram. Set up right northbound lane advance warning signs and taper in order shown.

Outline worksite with cones.

Commence work.

1.3 Work on edge of roadway

Note:
All two-way signs must face both directions of travel.

Note:
3.3m MIN
LANE WIDTH

Note:
This drawing is a graphical
representation of the detour set-up.
It is **not** drawn to scale.

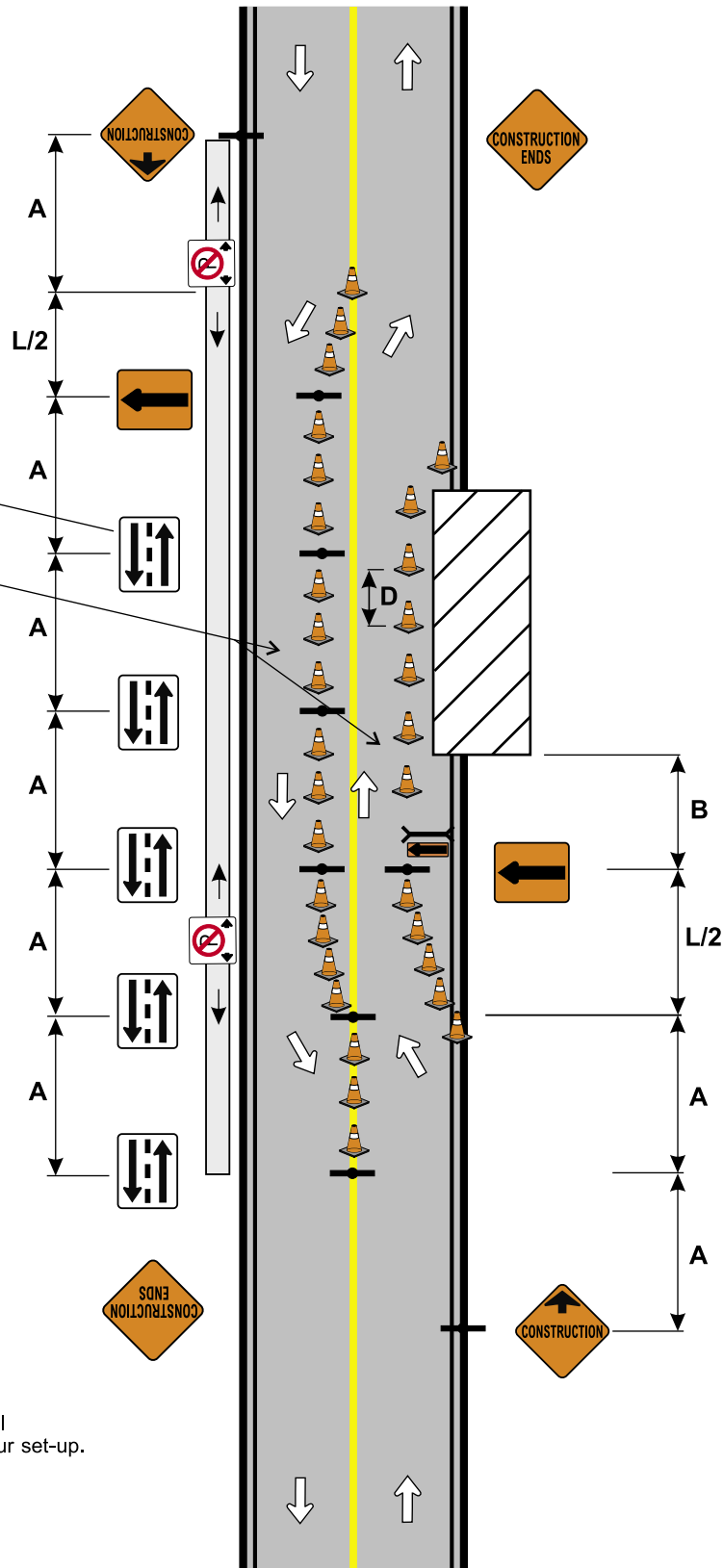

2.1 Moving jobs

1. Example shown

Two-lane – one-way street.

2. Conditions

Mobile/moving jobs are those that are typically done on the move at low speed and may require periodic stopping for only a few minutes duration.

3. Observations

Delineation devices are not required if the operation does not involve stopping.

4. Set-up procedure

Set up signage and devices as required.

Commence work.

2.1 Moving jobs

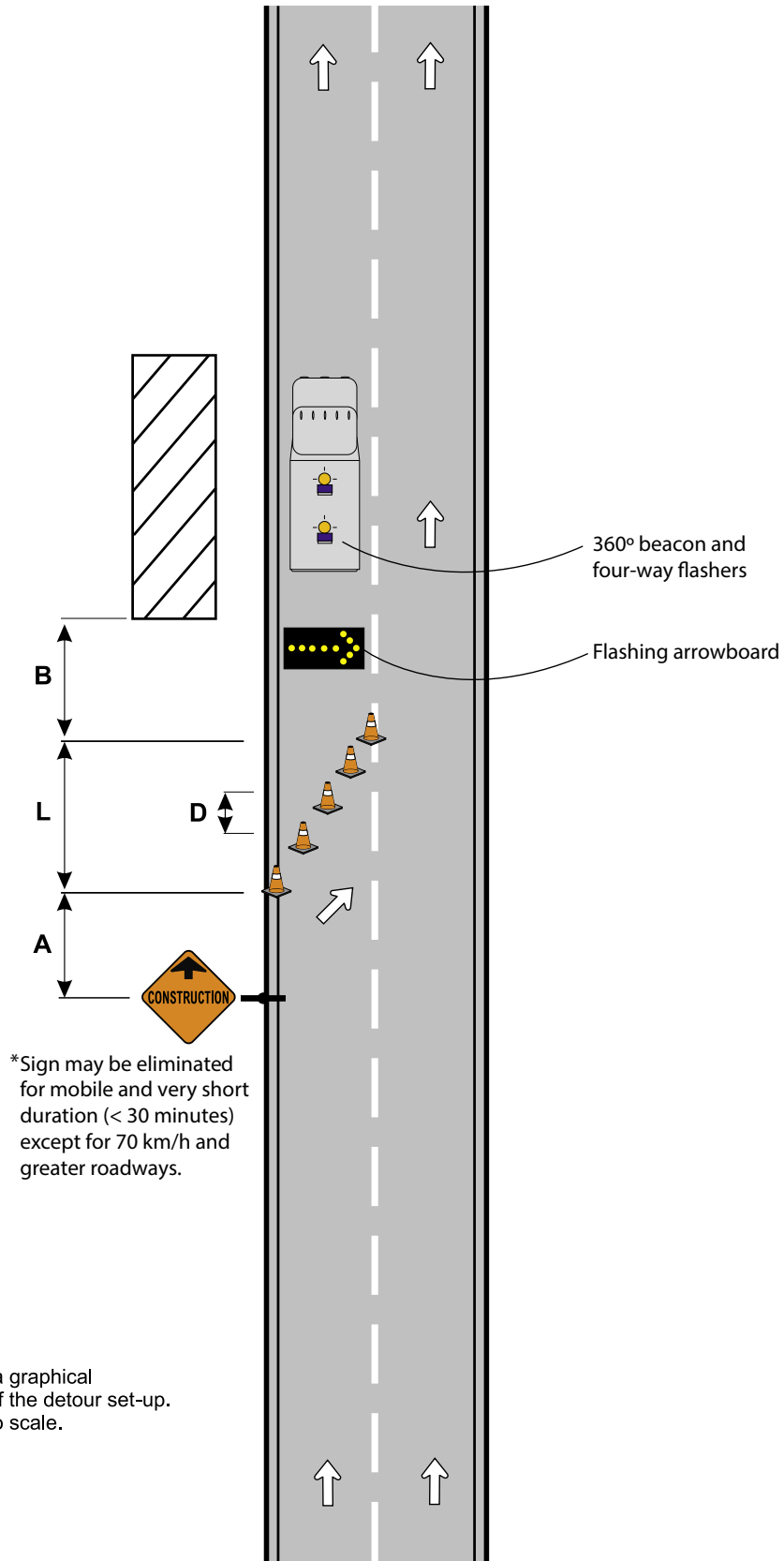

Note:
This drawing is a graphical representation of the detour set-up. It is **not** drawn to scale.

2.2 Mobile operations on residential

1. Example shown

Residential roadway

No encroachment on sidewalk. If sidewalk closure is needed, please use sidewalk closure example

2. Conditions

Duration of work: 30 minutes or less

Must maintain room for vehicles to pass. i.e. emergency vehicles

3. Observations

360° Beacon and 4-way Flashes or Flashing Arrow Board must be used to alert oncoming traffic of work ahead

4. Set-up procedure

After parking your work vehicle, setup cones around vehicles/site

2.2 Mobile operations on residential

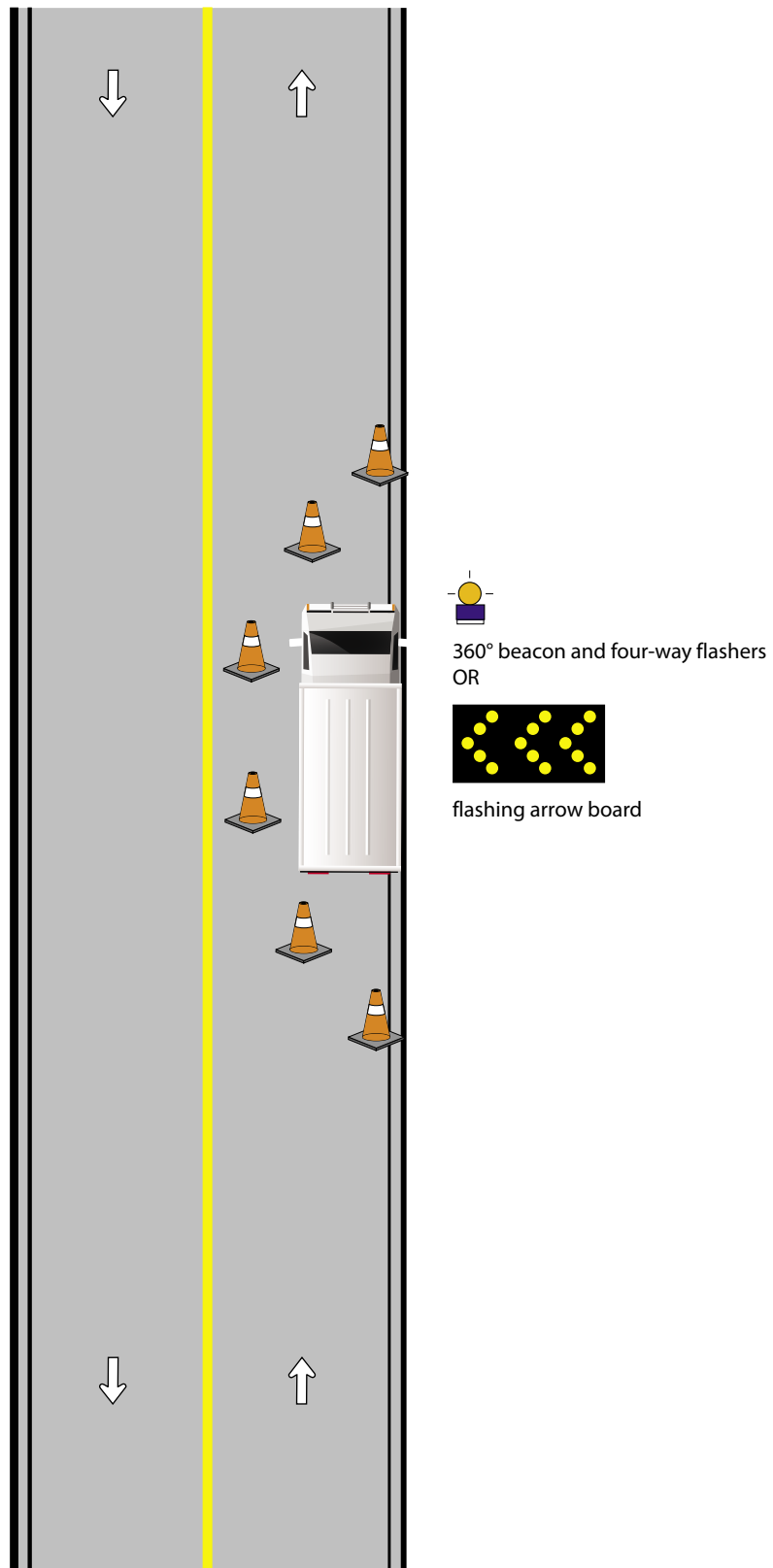

2.3 Mobile operations on collector or arterial $v \leq 60$ km/h

1. Example shown

Collector or arterial road.

2. Conditions

Duration of work: 30 minutes or less.

3. Observations

Flashing arrow board must be used to alert oncoming traffic of work ahead.

4. Set-up procedure

After parking your work vehicle, turn on flashing arrow board to alert oncoming traffic of work ahead.

2.3 Mobile operations on collector or arterial $v \leq 60$ km/h

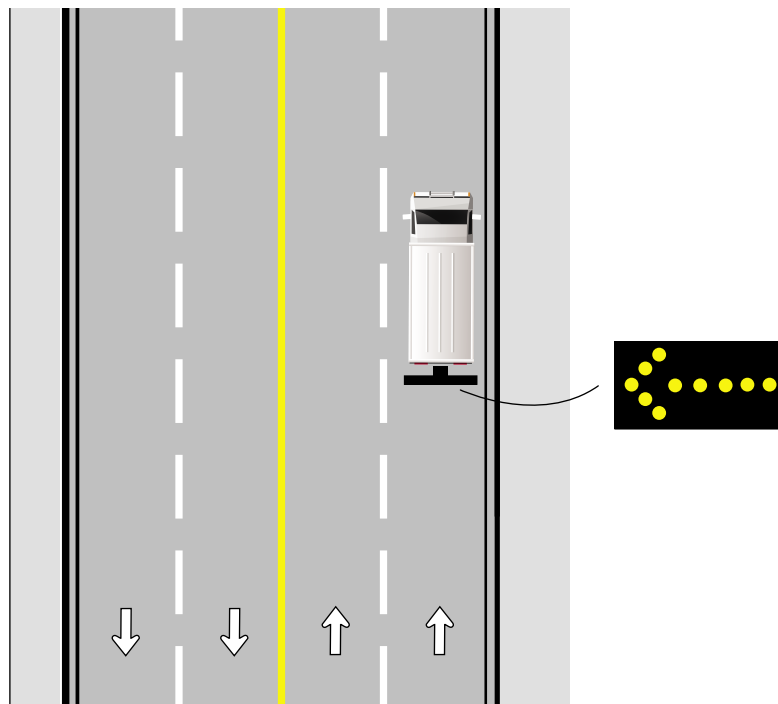
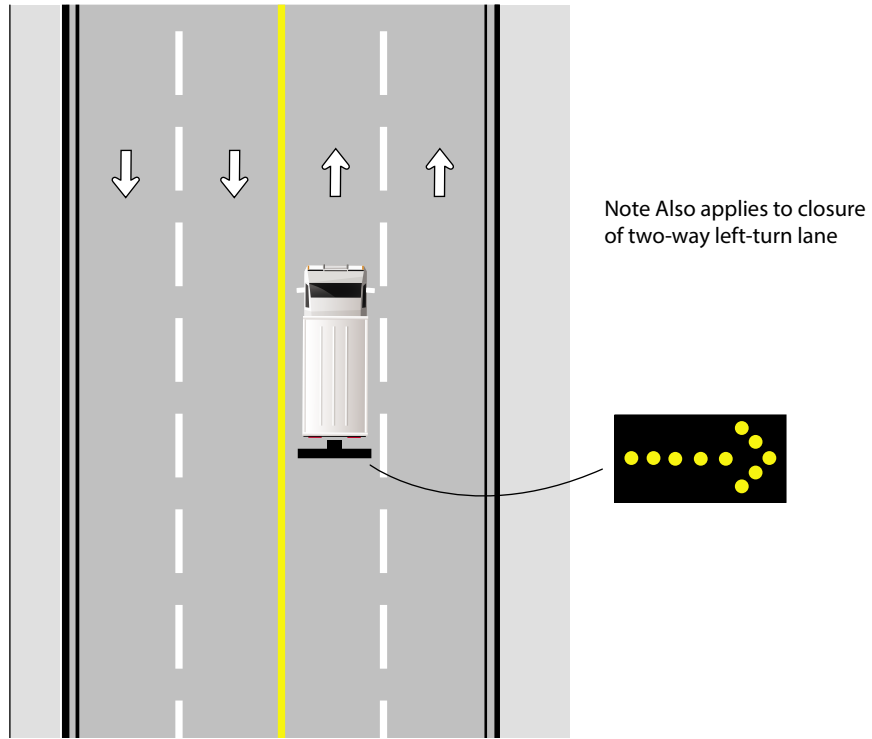

2.4 Mobile shoulder work

1. Example shown

Two-lane – two-way street with parking lane/shoulder.

No encroachment in lane.

2. Conditions

Approaching traffic must be able to pass by worksite while remaining completely within their own lane.

3. Observations

Applies to mobile work outside of the travel lanes.

4. Set-up procedure

After parking your vehicle, setup cones around vehicles/site.

2.4 Shoulder work

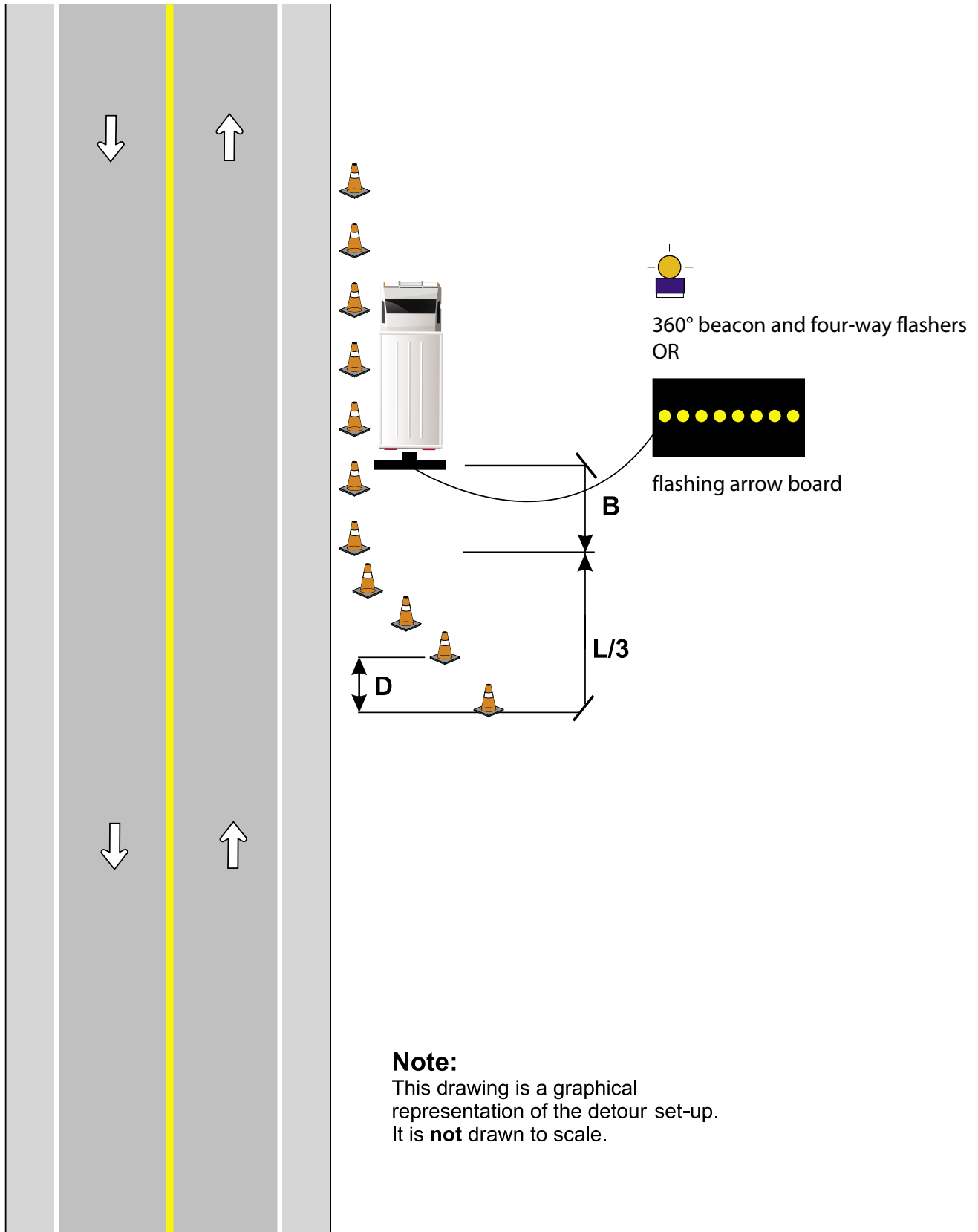

3.1 Yield to oncoming traffic

1. Example shown

Two-lane – two-way street.

2. Conditions

Single lane closure.

Residential street – low volume roads only.

3. Observations

Used for securing a worksite during periods of inactivity. During working hours, refer to two-way flagging operation.

Overnight set-up requires use of flashers. (Refer to Chapter 4; Delineation (Channelization) devices for flasher use.)

4. Set-up procedure

Set up No Parking zone and have inspected by the Calgary Parking Authority 12 hours (minimum) prior to restriction.

Start at top of diagram. Set up advance warning sign for the southbound lane.

Start at bottom of diagram. Set up advance warning signs in order shown. Set up taper and outline worksite with cones.

Commence work.

3.1 Yield to oncoming traffic

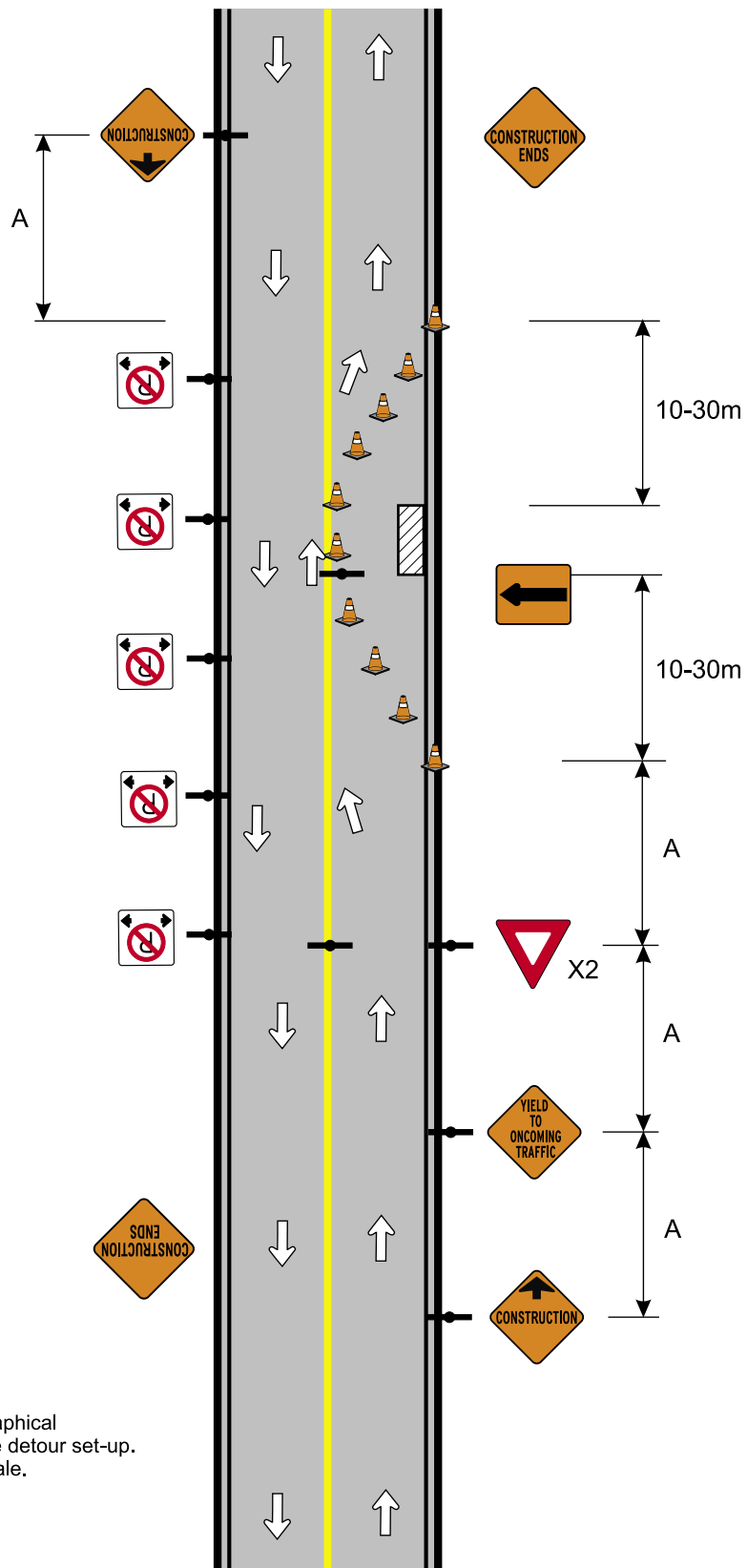

Note:
 This drawing is a graphical representation of the detour set-up. It is **not** drawn to scale.

3.2 Single right lane closure

1. Example shown

Two-way – four-lane street.

2. Conditions

Closure of single lane.

3. Observations

Right Lane Closed sign to allow reaction time for motorists to change lanes.

4. Set-up procedure

Start at bottom of diagram. Set up advance warning signs in order shown.

Set up taper and outline worksite with cones.

Commence work.

3.2 Single right lane closure

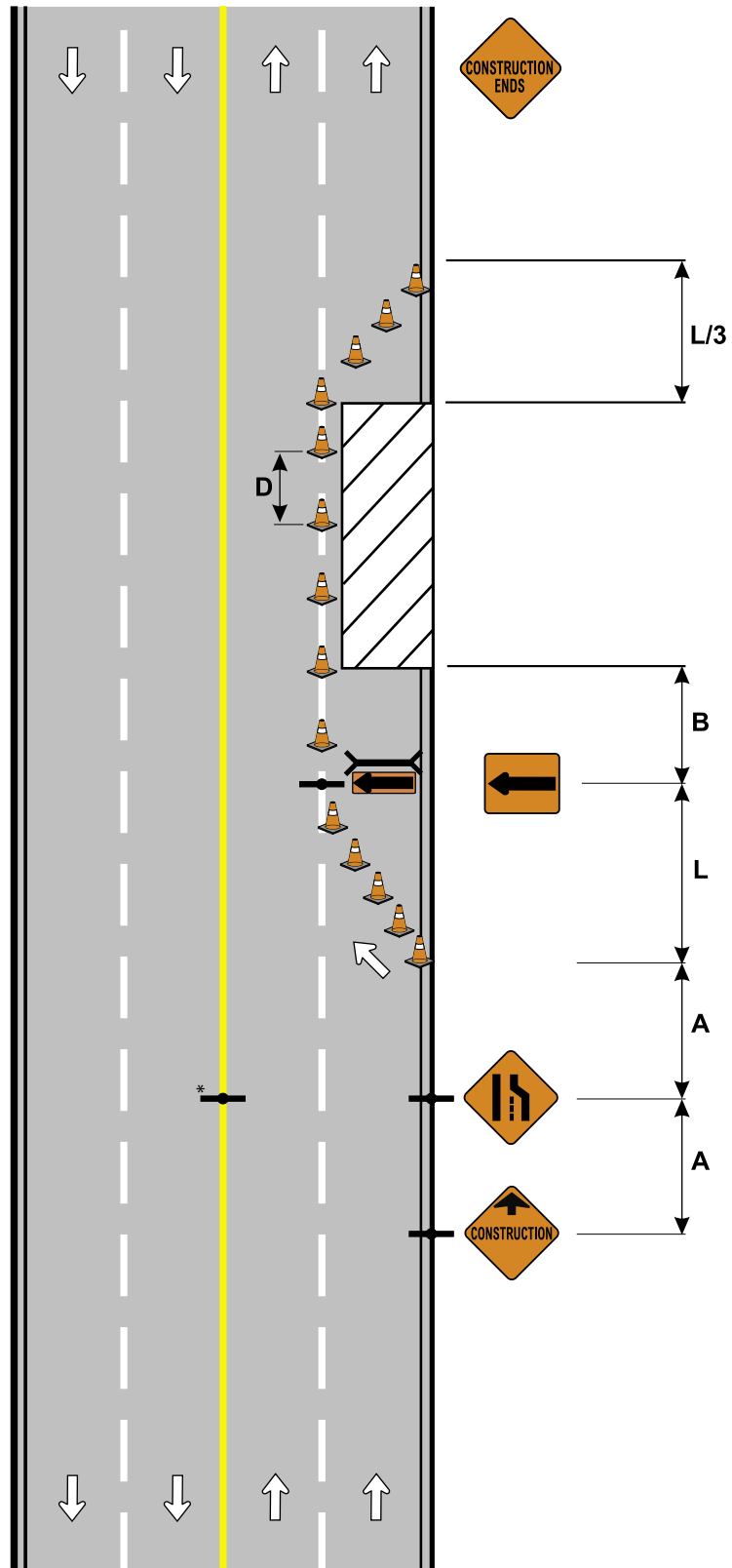

*An additional Temporary Lane Closed Ahead sign should be placed adjacent to the left lane where median space may permit sign placement.

Note:
This drawing is a graphical representation of the detour set-up. It is **not** drawn to scale.

3.3 Single left lane closure

1. Example shown

Two-way – four-lane street.

2. Conditions

Closure of single lane.

3. Observations

Note signing on centre line of road.

Rectangular “text” lane closure signs may be used where conditions do not allow for diamond-shaped signs.

4. Set-up procedure

Start at bottom of diagram. Set up advance warning signs in order shown.

Set up taper and outline worksite with cones. Set up sign at top of diagram.

Commence work.

3.3 Single left lane closure

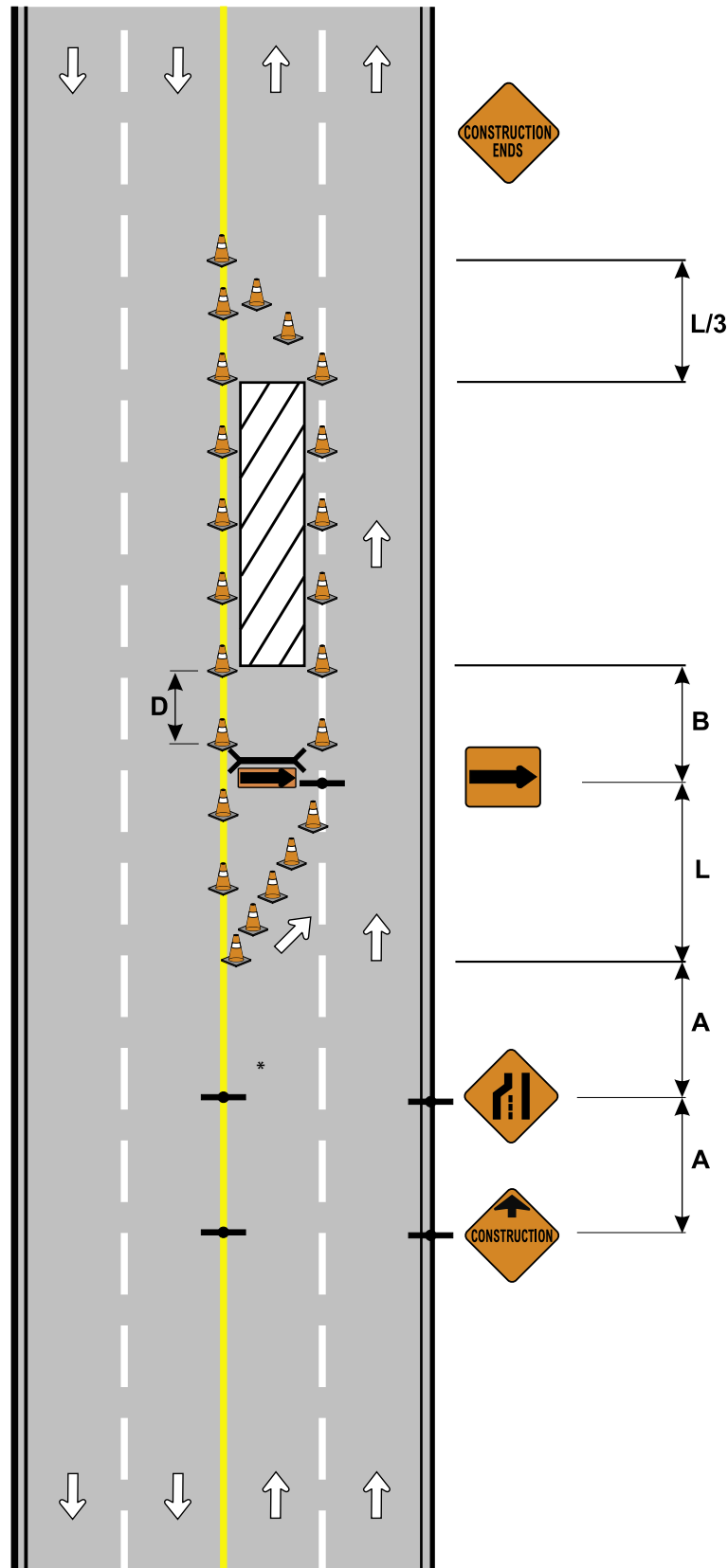

* An additional Temporary Lane Closed Ahead sign should be placed adjacent to the left lane where median space may permit sign placement.

Note:
This drawing is a graphical representation of the detour set-up. It is **not** drawn to scale.

3.4 Speed reduction with right lane closure

1. Example shown

Divided two-way, four-lane street.

2. Conditions

Closure of right lane.

3. Observations

Note: Use of arrow board signs to allow more reaction time for motorists to change lanes.

Note: Construction Ahead, 50 Ahead and Maximum 50 signs are used on both sides of the roadway.

4. Set-up procedure

Start at bottom of diagram.

Set up advance warning signs in order shown.

Set up taper and outline worksite with cones.

Commence work.

Please refer to Appendix F for "Maximum speed ahead" sign placement chart.

3.4 Speed reduction with right lane closure

Note:
This drawing is a graphical representation of the detour set-up. It is not drawn to scale.

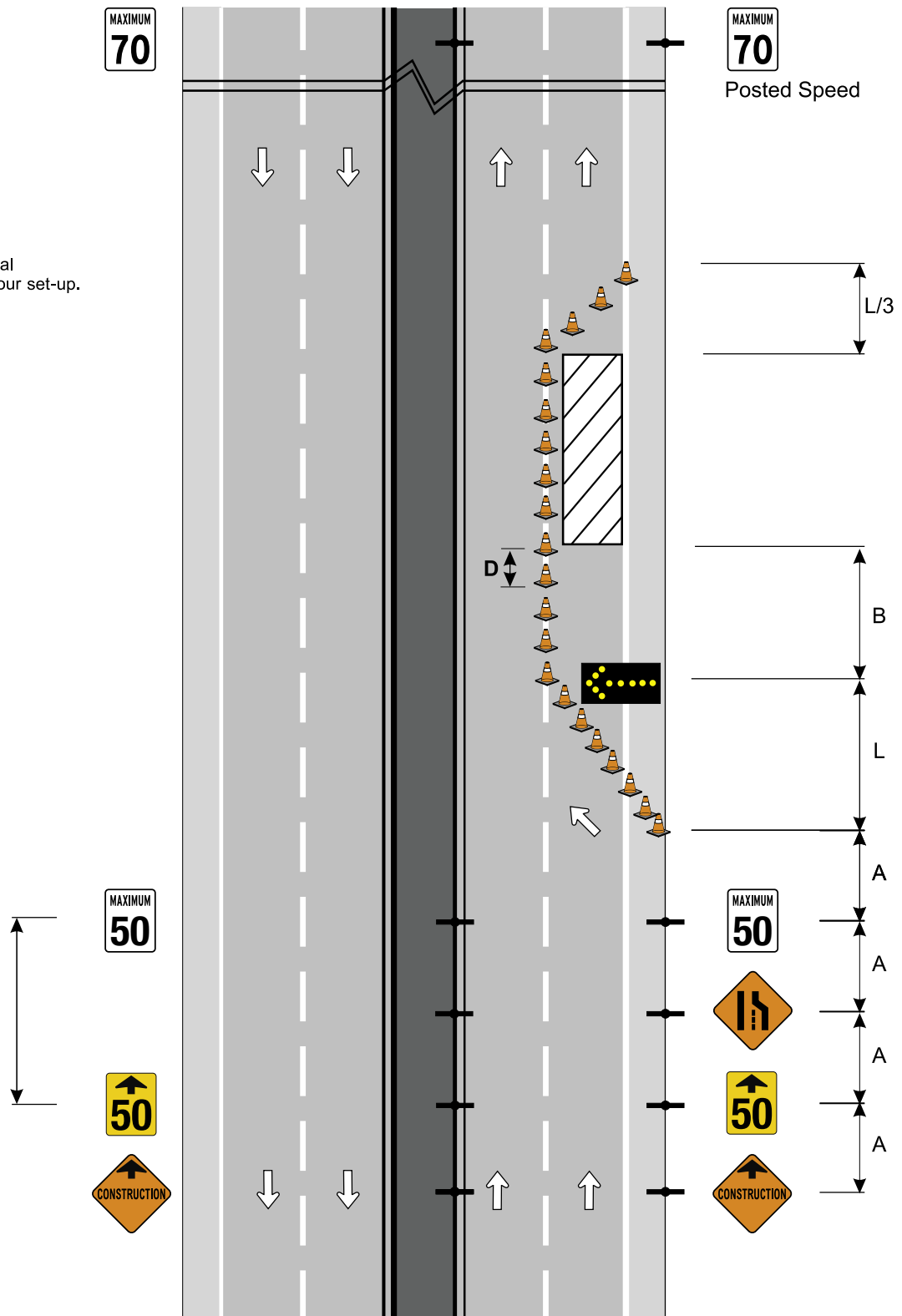

* Refer to chart for minimum distance

* Maximum speed ahead sign placement chart can be found in Appendix F.

4.1 Automated flagging operation

1. Example shown

Two-lane – Two way street.

2. Conditions

Long term work on a two way street with one lane completely blocked with an automated flagger assistance device.

3. Observations

For speed in excess of 50 km/h, a speed reduction set-up is required.

Authenticated engineering drawing required for temporary traffic control and signal design.

4. Set-up procedure

Set up advance warning signs on both sides in order shown.

Set up speed reduction if necessary.

Set up automated flagger assistance device and make sure it is working and the programming is correct.

Set up taper and outline worksite with cones.

Commence work.

3.1 Automated flagging operation

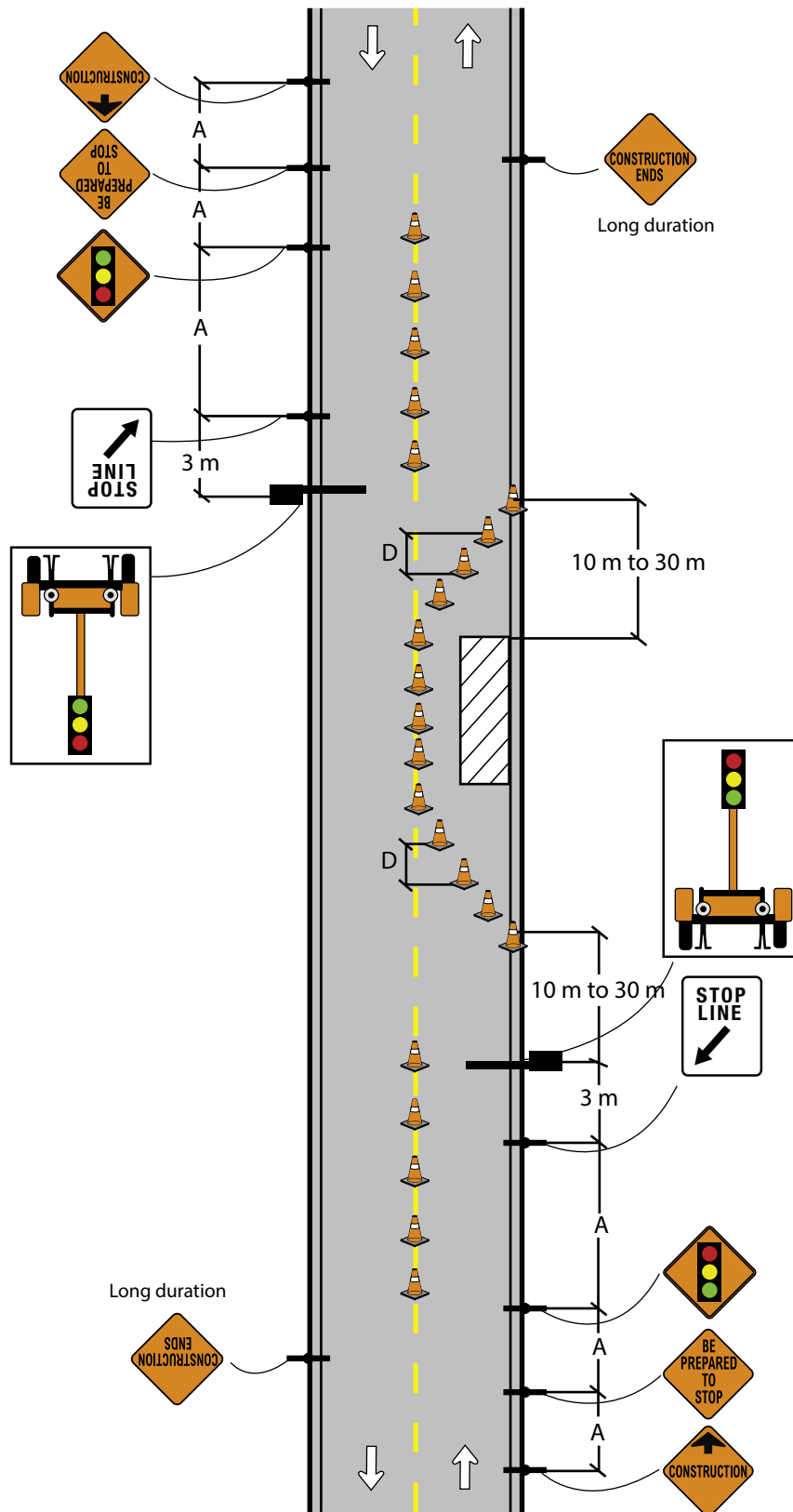

4.2 Two-way flagging operation

1. Example shown

Two-lane – two-way street.

2. Conditions

One lane of traffic will be completely blocked. May extend worksite into second lane, provided enough space for traffic to drive by worksite (min. 3 m). Minimum for emergency/transit access (3.3 m).

3. Observations

For speeds in excess of 50 km/h, a speed reduction set-up is required.

Flagger on upper left of diagram must stop traffic far enough back to allow oncoming traffic access to northbound lane.

Recommend installing No Parking zones on both sides of road.

4. Set-up procedure

Set up No Parking zone first. Have inspected by the Calgary Parking Authority 12 hours (minimum) prior to restriction.

Set up advance warning signs on both sides in order shown.

Post traffic control persons.

Set up taper and outline worksite with cones.

Commence work.

3.2 Two-way flagging operation

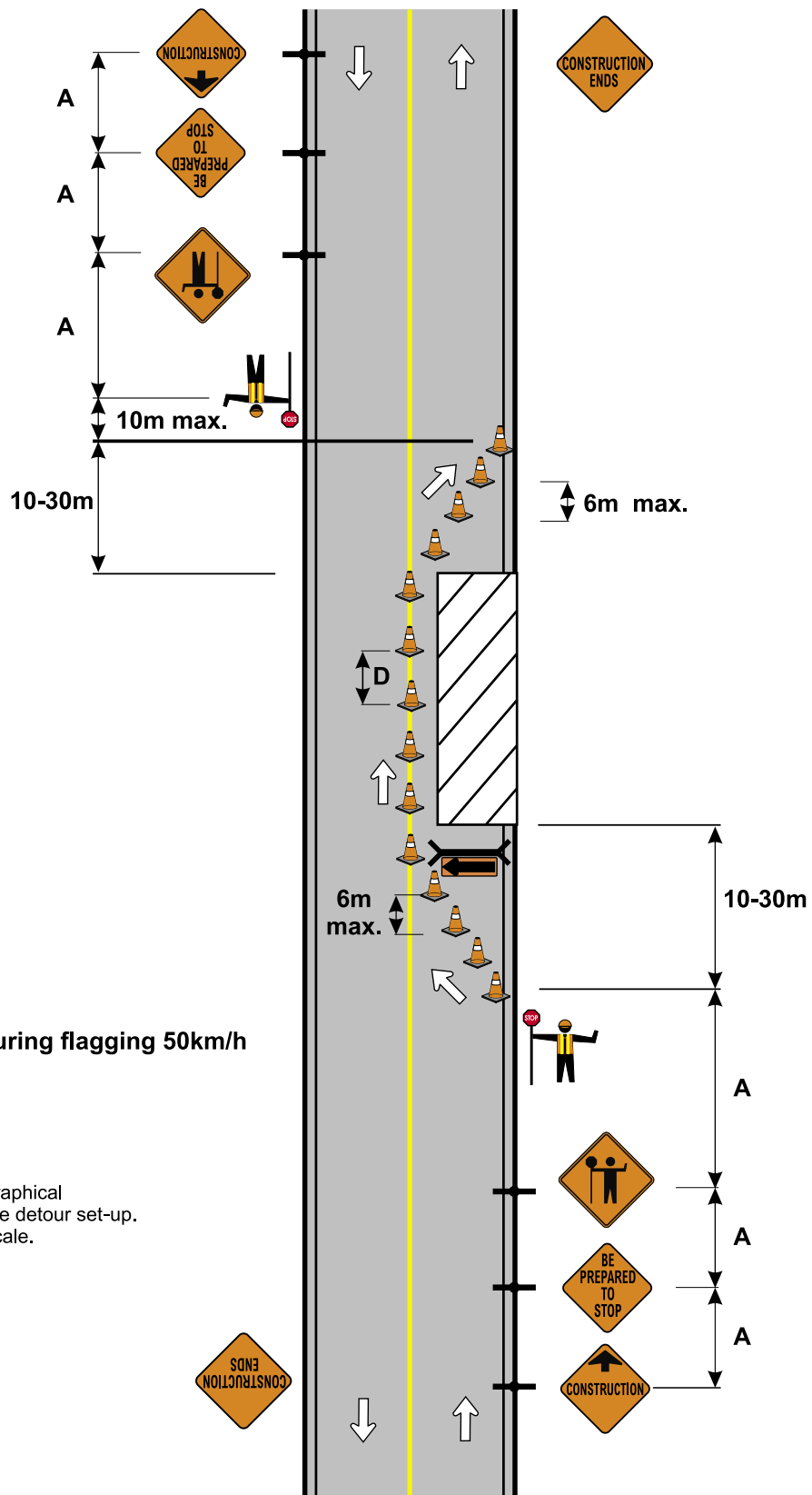

Note:
-Max. speed during flagging 50km/h

Note:
This drawing is a graphical representation of the detour set-up. It is **not** drawn to scale.

5.1 Multi-lane closure two right lanes

1. Example shown

Three-lane – one-way street.

2. Conditions

Two-lane closure.

3. Observations

Each lane must be closed separately and a straight section (tangent) provided between tapers.

Note use of arrow boards.

4. Set-up procedure

Start at bottom of diagram. Set up double-lane closure in order shown. Work towards top of diagram.

Outline worksite with cones.

Commence work.

5.1 Multi-lane closure two right lanes

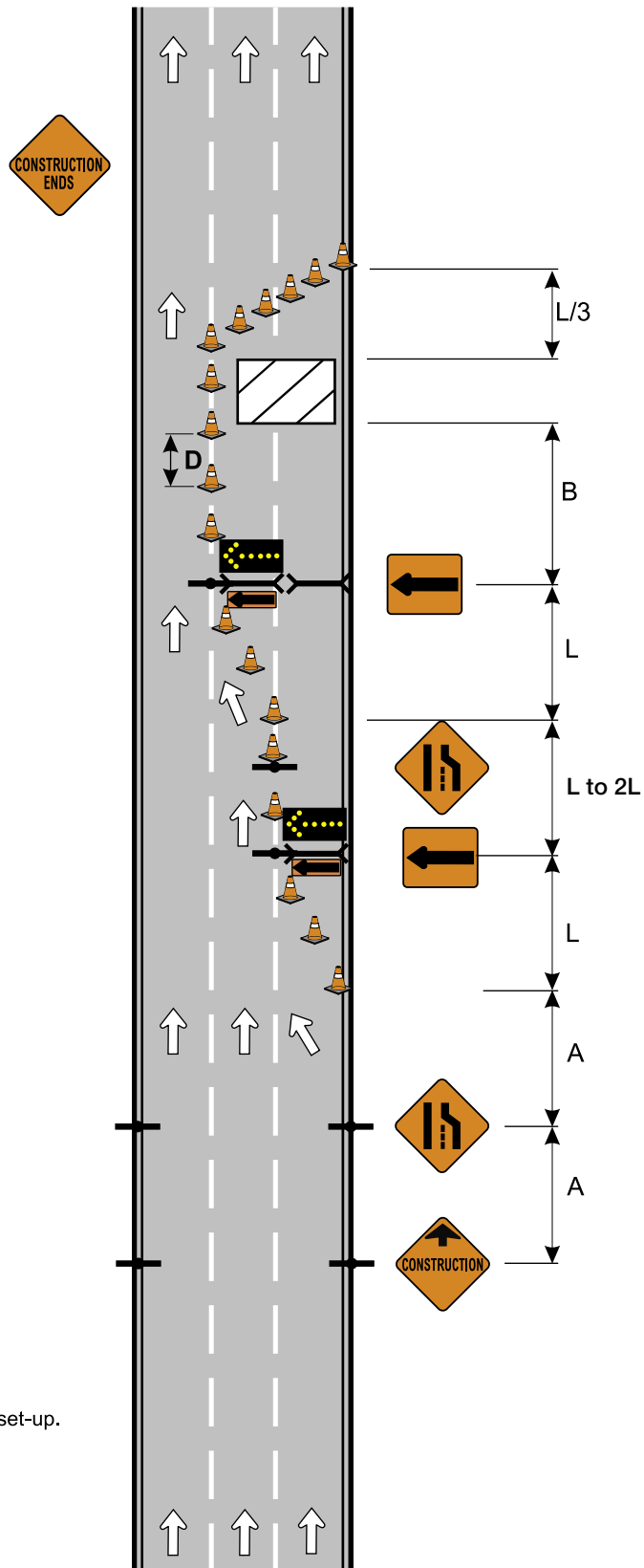

Note:
This drawing is a graphical representation of the detour set-up. It is **not** drawn to scale.

5.2 Multi-lane closure two left lanes

1. Example shown

Three-lane – one way street.

2. Conditions

Two-lane closure.

3. Observations

Each lane must be closed separately and a straight section (tangent) provided between tapers.

Note use of arrow boards.

4. Set-up procedure

Start at bottom of diagram. Set up double-lane closure in order shown. Work towards top of diagram.

Outline worksite with cones.

Commence work.

5.2 Multi-lane closure two left lanes

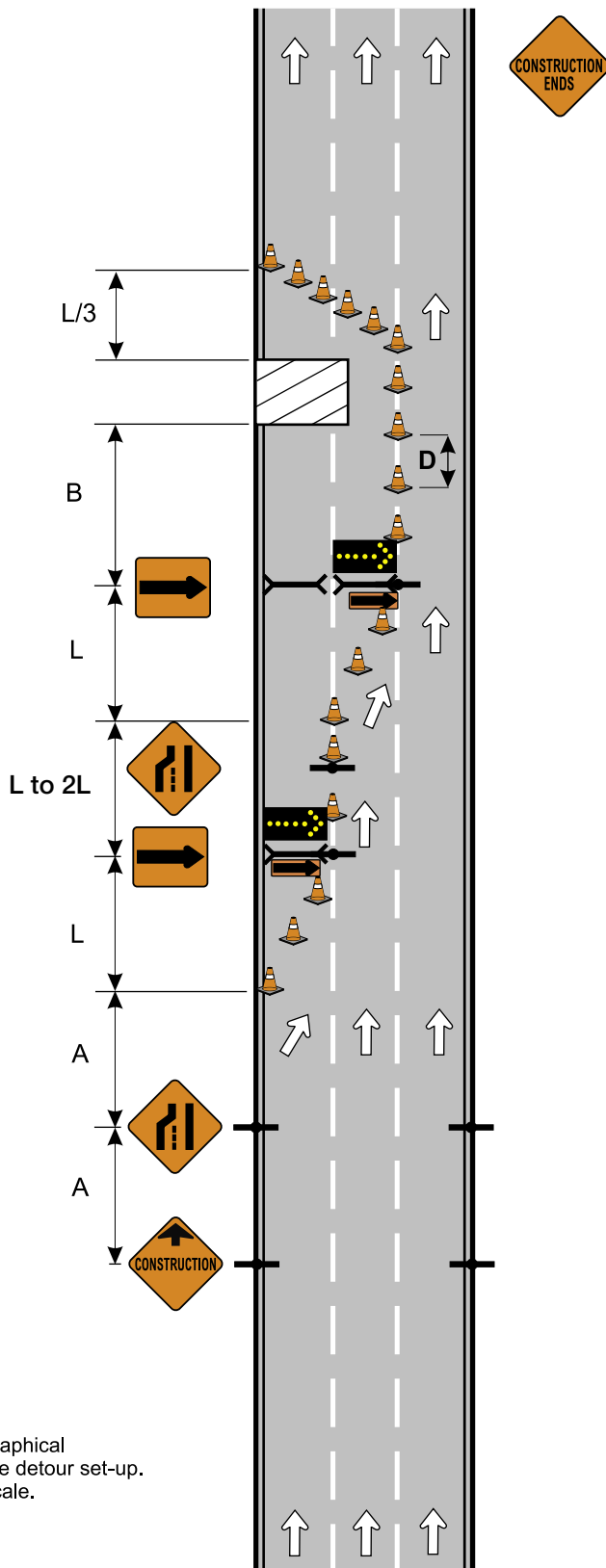

Note:
This drawing is a graphical representation of the detour set-up. It is **not** drawn to scale.

5.3 Multi-lane closure left lane closed in each direction

1. Example shown

Four-lane – two-way street.

2. Conditions

Set up two single-lane closures, one in each direction.

3. Observations

Use traffic control persons to protect workers during set-up.

Rectangular “text” lane closure signs may be used where conditions do not allow for diamond shaped signs.

4. Set-up procedure

Set up advance warning signs from top and bottom of diagram in order shown.

Set up tapers and outline work area with cones.

Commence work.

5.3 Multi-lane closure left lane closed in each direction

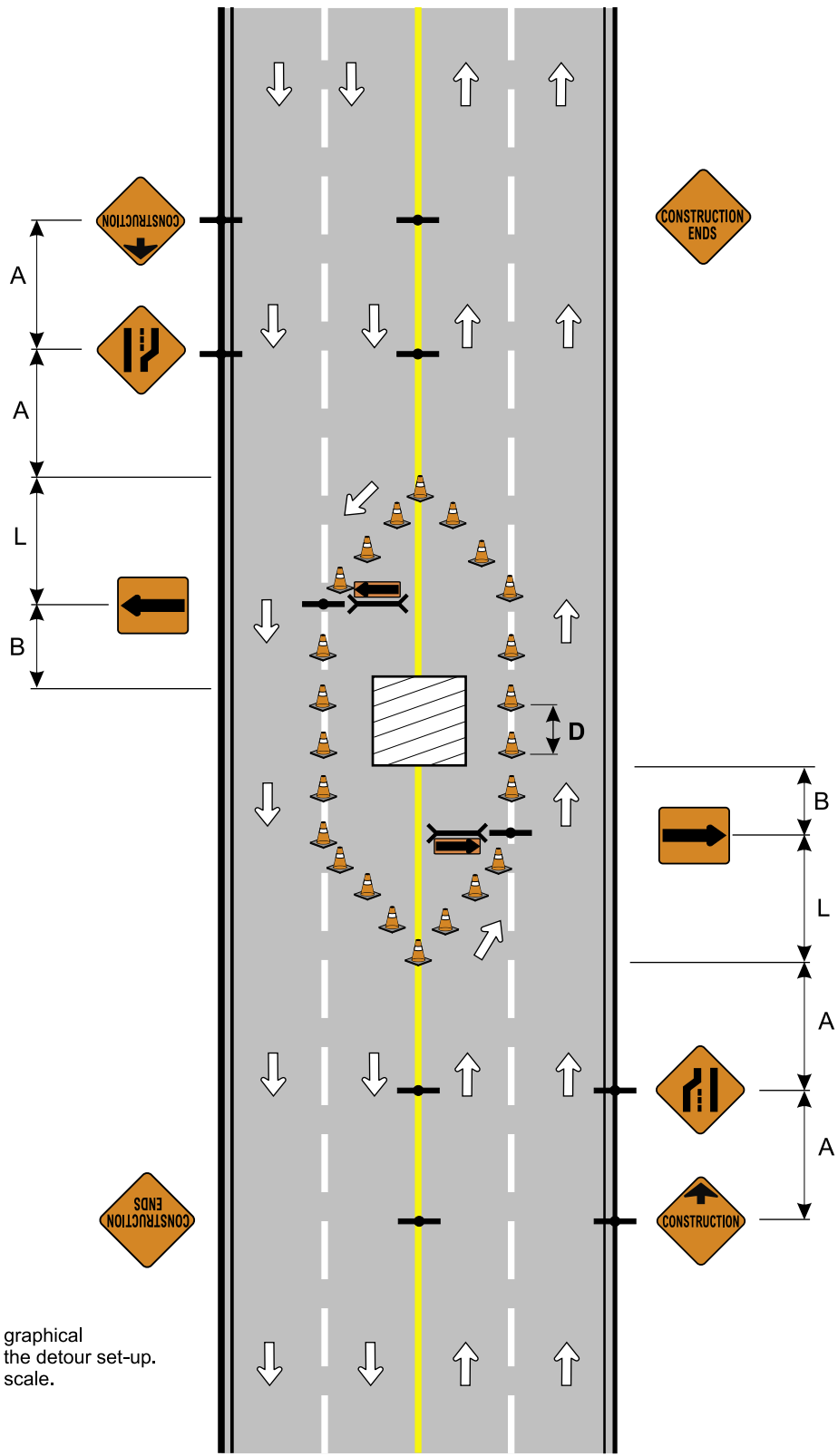

Note:
 This drawing is a graphical representation of the detour set-up. It is **not** drawn to scale.

5.4 Shoulder detour

1. Example shown

Four-lane – two-way street with shoulder.

2. Conditions

Two-lane closure requires shoulder detour.

3. Observations

Note speed reduction may be necessary.

Use traffic control persons to protect workers during set-up.

Temporary lane on shoulder must be minimum 3.3 metre width.

Shoulder must be able to withhold traffic load. Median crossover may be alternative option.

4. Set-up procedure

Set up delineators and barricades along shoulder to mark detour.

Post traffic control persons.

Start at bottom of diagram. Set up double-lane closure in order shown.

Commence work.

5.4 Shoulder detour

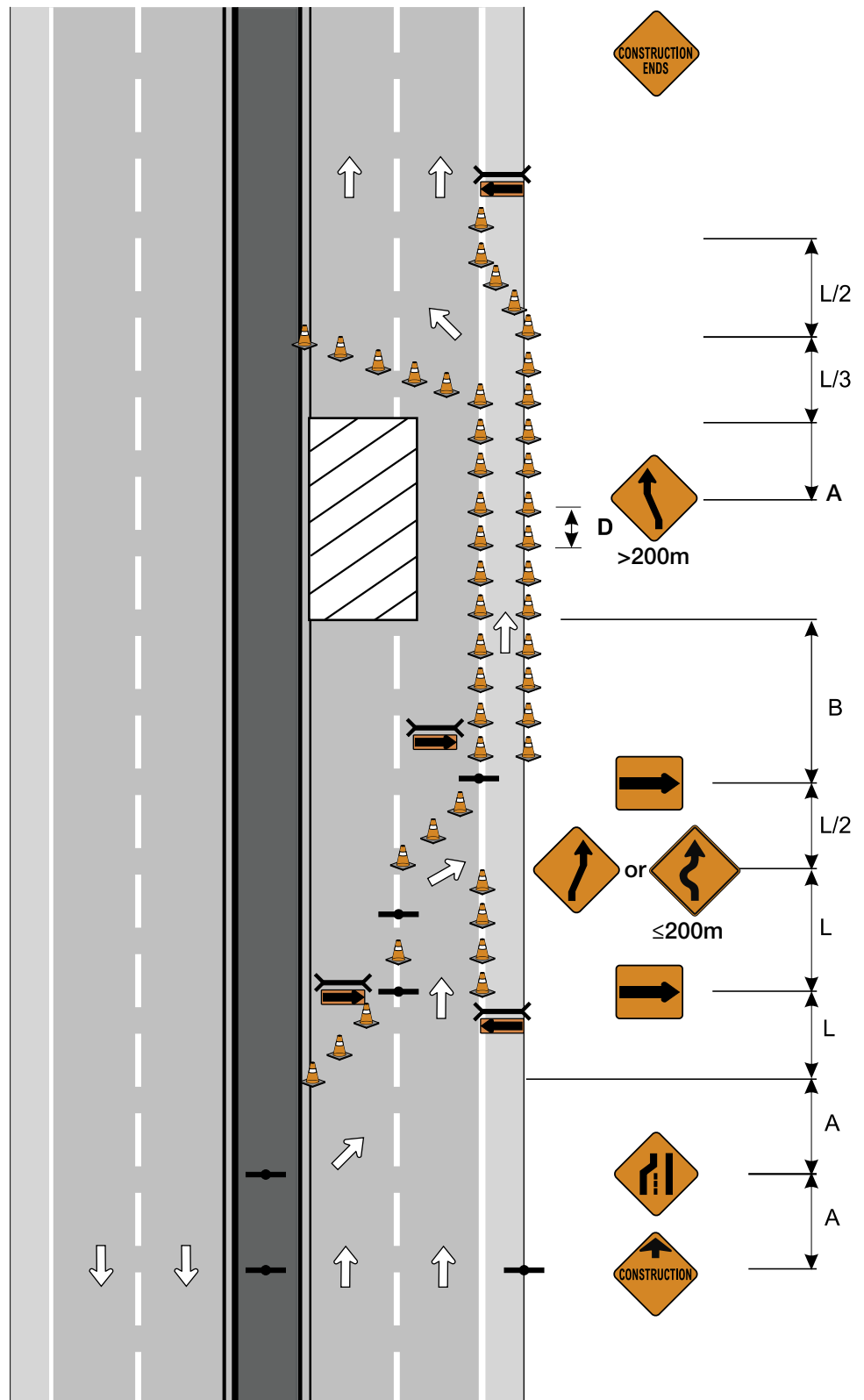

Note:
This drawing is a graphical representation of the detour set-up. It is **not** drawn to scale.

5.5 Road diversion two directions

1. Example shown

Two-lane – two-way street.

2. Conditions

Closure requires diversion.

3. Observations

May require speed reduction.

Note use of delineators around diversion. Construction markers and flashers to be used at night and during periods of inactivity.

Use traffic control persons to protect workers during set-up.

Use of chevrons to be considered depending on horizontal alignment.

4. Set-up procedure

Build diversion route where necessary to accepted standards.

Set up delineators, barricades and signs on both sides of diversion.

Commence work.

5.5 Road diversion two directions

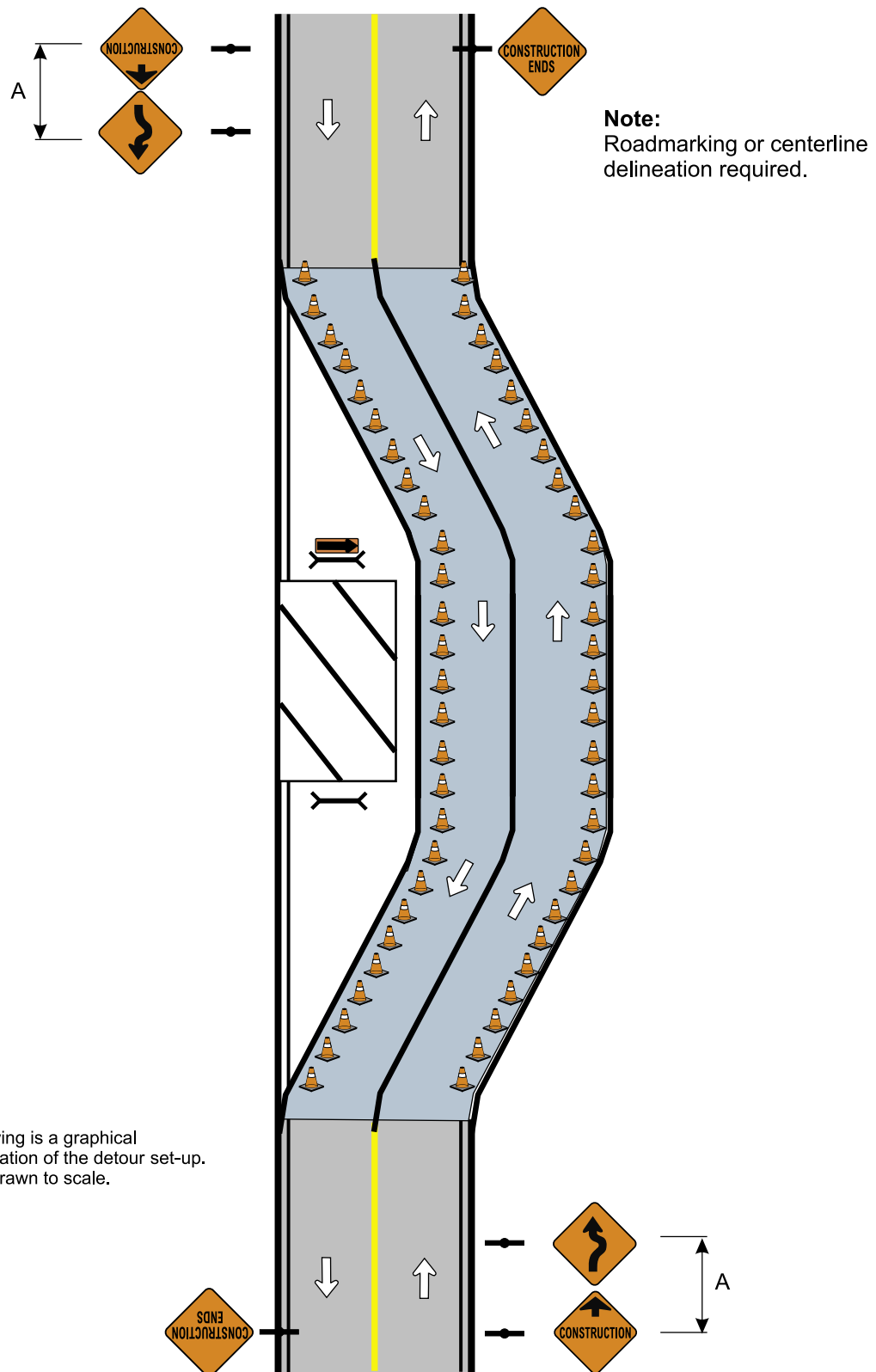

6.1 Centre line crossover two-way traffic

Note: Two way signs must face both directions of travel.

1. Example shown

Four-lane – two-way street.

2. Conditions

Two-lane closure in one direction.

Single-lane closure in the other direction.

3. Observations

Rectangular “text” lane closure signs may be used where conditions do not allow for diamond shaped signs.

Placement of two-way traffic signs.

4. Set-up procedure

Southbound traffic must be diverted first. Start at top of diagram. Set up single-lane closure, two tapers, barricade and two-way traffic signs in order shown.

Traffic on right side may now be diverted into oncoming traffic lane. Start at bottom right of diagram.

Set up double-lane closure in order shown. Outline work area with cones.

Commence work.

6.1 Centre line crossover two-way traffic

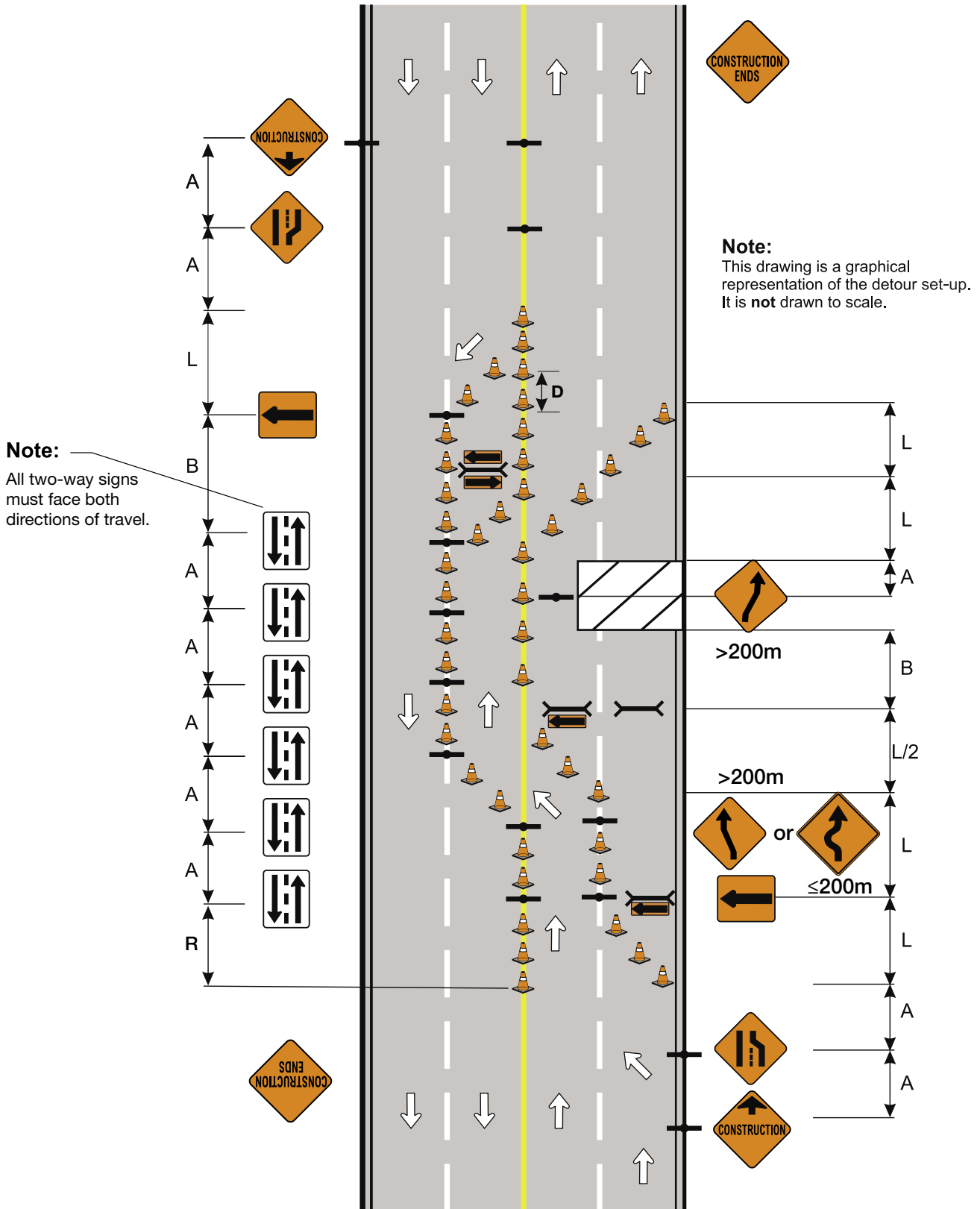

6.2 Median crossover two-way traffic

Authenticated engineering drawing required for median crossover. Taper lengths designed per posted speed.

Note: Two way signs must face both directions of travel.

1. Example shown

Divided two-way, four-lane street.

2. Conditions

One lane of traffic must cross median.

3. Observations

Removal of median may be required or curbs may need to be treated with asphalt to allow crossover.

Note use of arrow board.

Speed reduction may be required.

4. Set-up procedure

Traffic on left side must be diverted first. Start at top of diagram. Set up single-lane closure, two tapers, barricade and two-way traffic signs in order shown.

Traffic on right side may now be diverted into oncoming traffic lane. Start at bottom right of diagram. Set up double-lane closure in order shown. Outline worksite with cones.

Commence work.

6.2 Median crossover two-way traffic

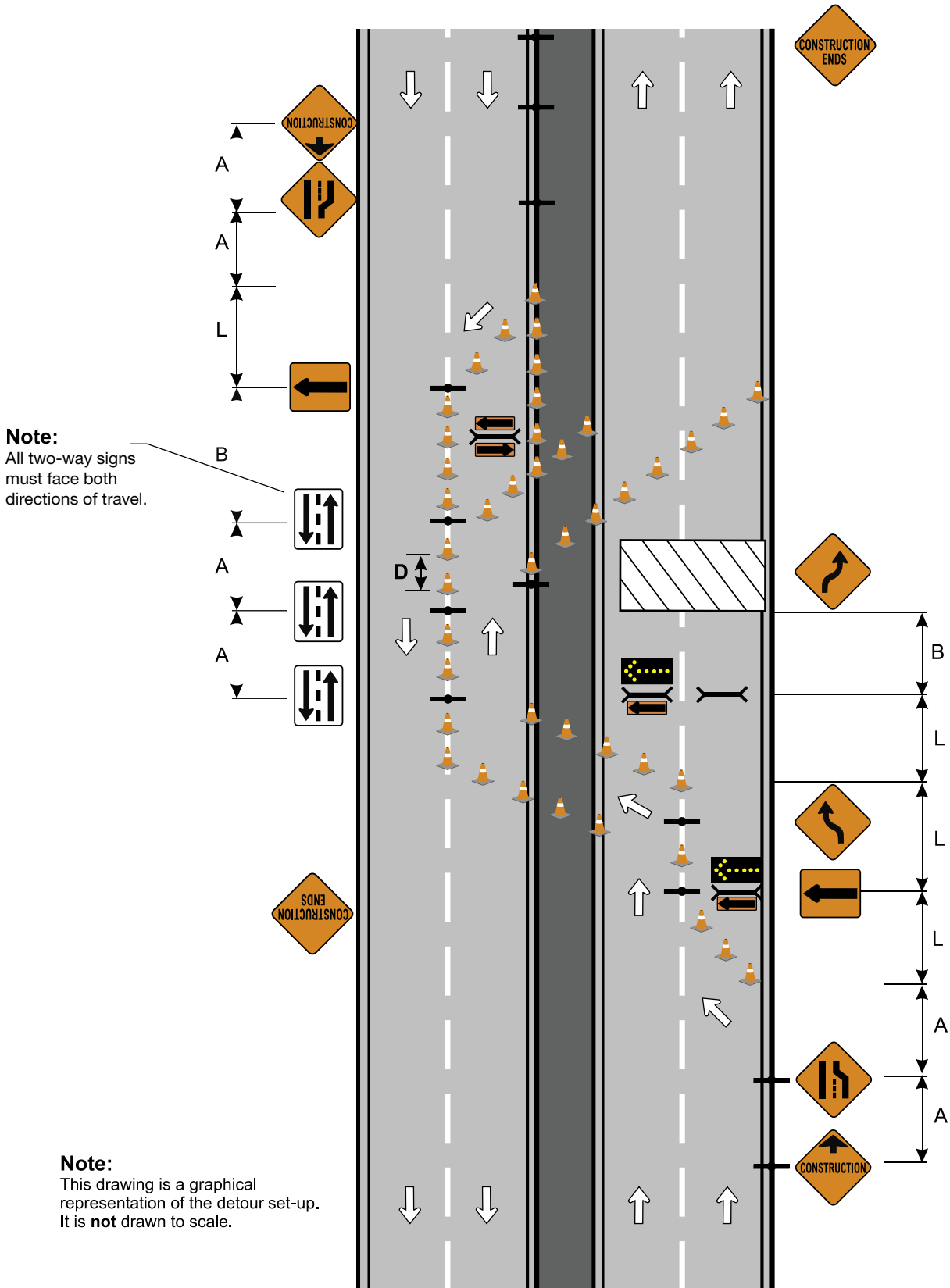

Note:
All two-way signs must face both directions of travel.

Note:
This drawing is a graphical representation of the detour set-up. It is **not** drawn to scale.

6.3 Two-way left-turn lane closed

1. Example shown

Two-way – five-lane street with median two-way left-turn lane.

2. Conditions

Closure of median two-way left-turn lane.

3. Observations

Note use of advance warning sign.

4. Set-up procedure

Set up advance warning sign and then cones.

Commence work.

6.3 Two-way left-turn lane closed

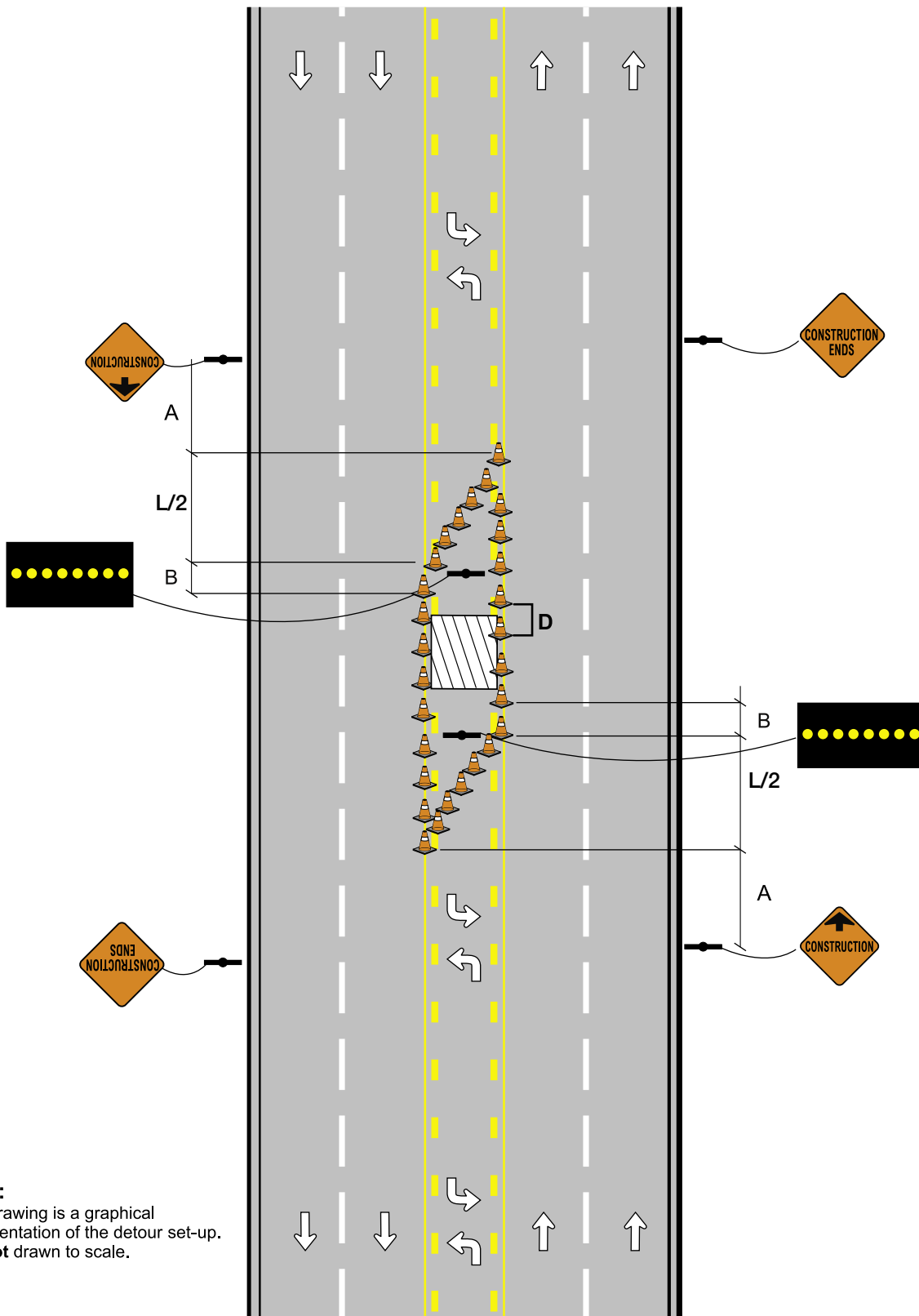

Note:
This drawing is a graphical representation of the detour set-up. It is **not** drawn to scale.

7.1 Intersection work – Example 1

1. Example shown

Two-lane – four-legged intersection.

2. Conditions

Require a portion of each lane in each direction.

3. Observations

Use traffic control persons to protect workers during set-up.

Use No Left Turn signs where applicable. Confirm vehicle turn path.

4. Set-up procedure

Set up all advance warning signs first.

Outline worksite with cones and Lane Closure Arrow signs.

Commence work.

7.1 Intersection work – Example 1

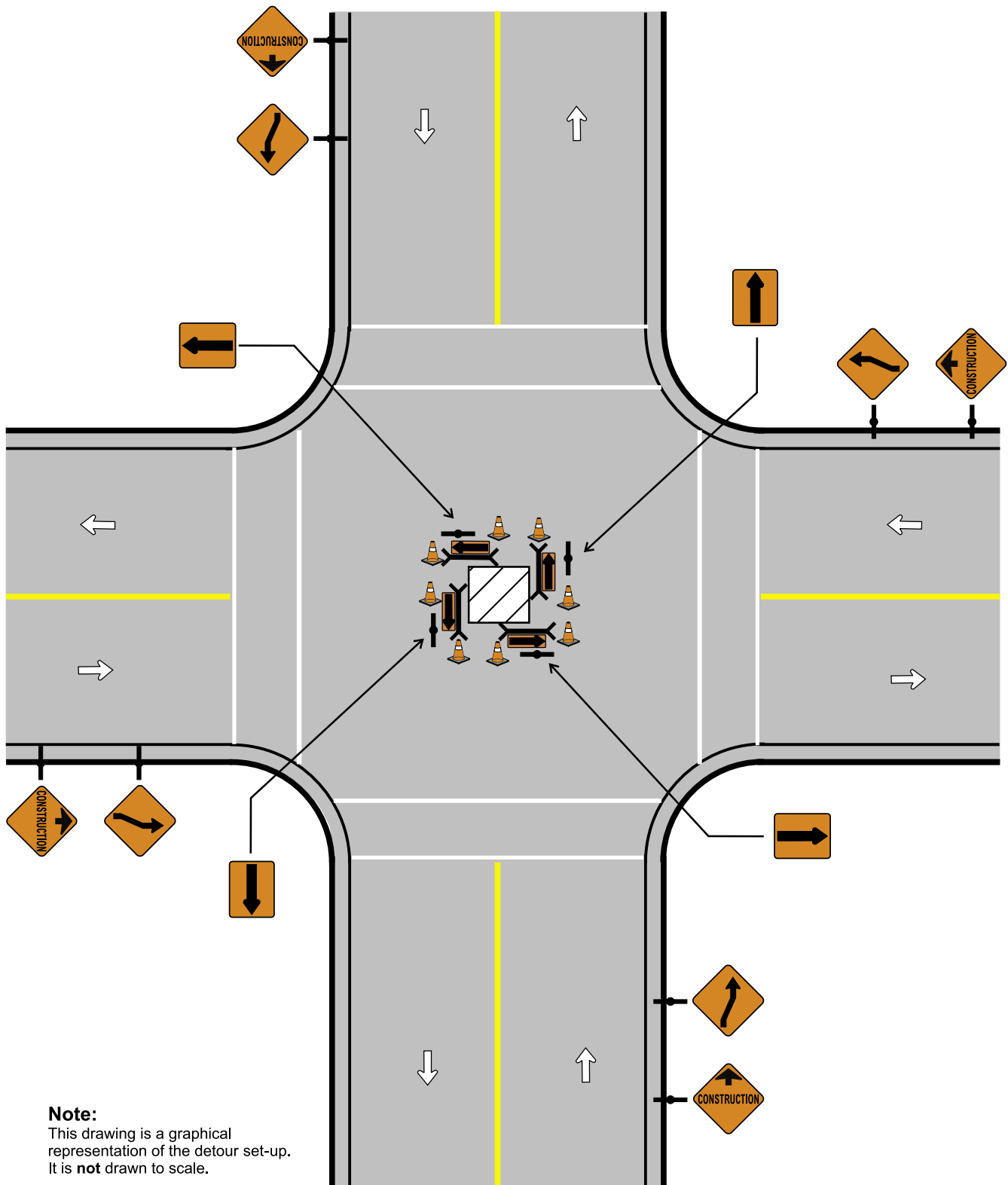

Note:
This drawing is a graphical representation of the detour set-up. It is **not** drawn to scale.

7.2 Intersection work – Example 2

Note: May require prohibition of left turn. Consult traffic signals group if impacted.

1. Example shown

Four-legged intersection. Two approaching lanes in all directions.

2. Conditions

Single-lane closure in all directions.

3. Observations

Note lane closures completed before reaching intersections.

4. Set-up procedure

Set up advance warning signs and tapers in each direction. Start from edges of diagram, working towards worksite in order shown.

Post traffic control persons to protect workers.

Outline worksite with cones.

Commence work.

7.2 Intersection work – Example 2

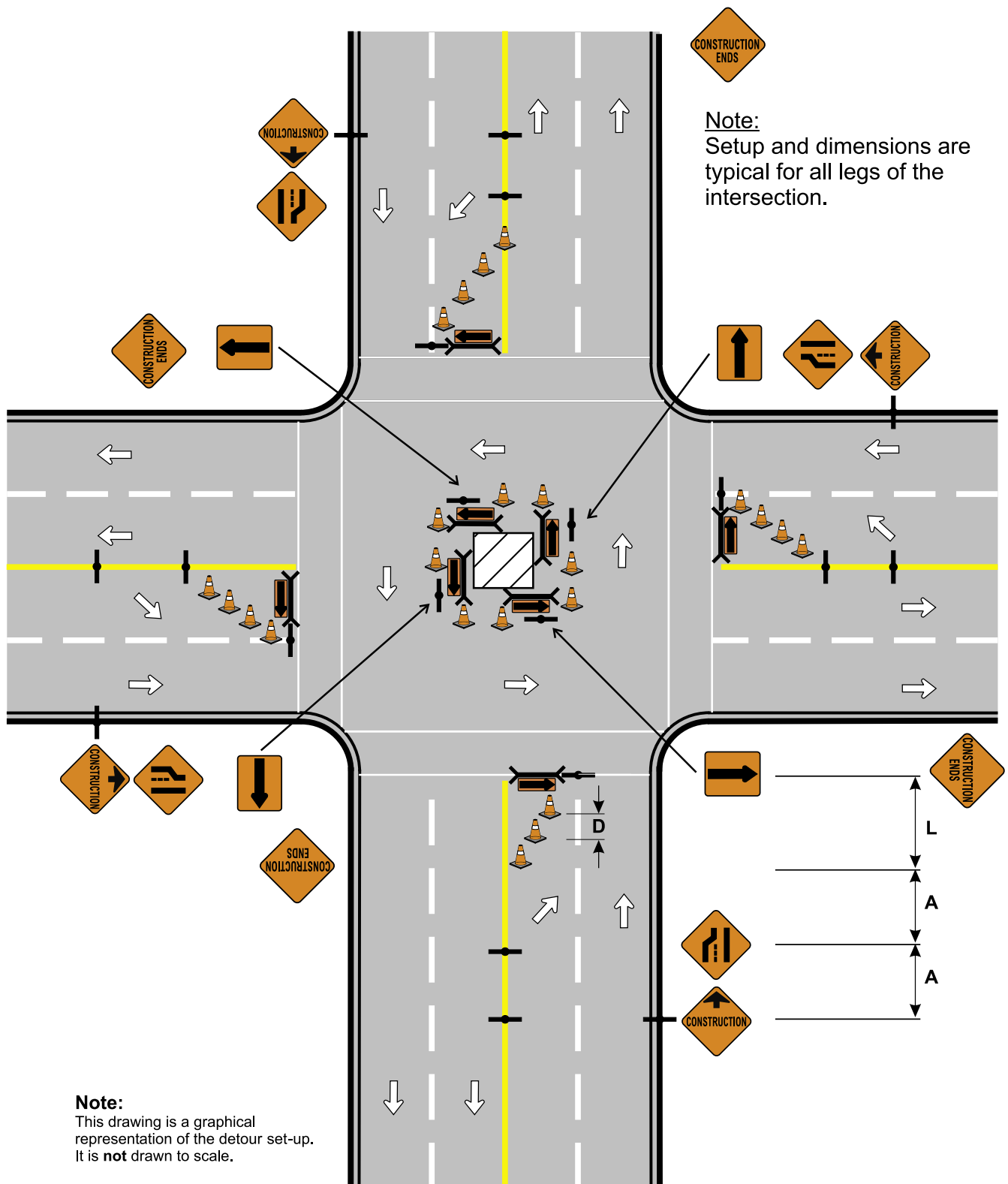

7.3 Intersection work – Example 3

1. Example shown

Four-legged intersection. Two approach lanes in all directions.

2. Conditions

Single-lane closure.

Single mandatory right lane condition.

3. Observations

Protect workers during set-up with traffic control persons.

Mandatory right lane may require closure depending on traffic volume.

4. Set-up procedure

Set up advance warning signs in order shown from right side of diagram.

Set up advance warning signs and taper in order shown from top of diagram.

Set up Lane Closure Arrow sign.

Outline worksite with cones and barricades.

Commence work.

7.3 Intersection work – Example 3

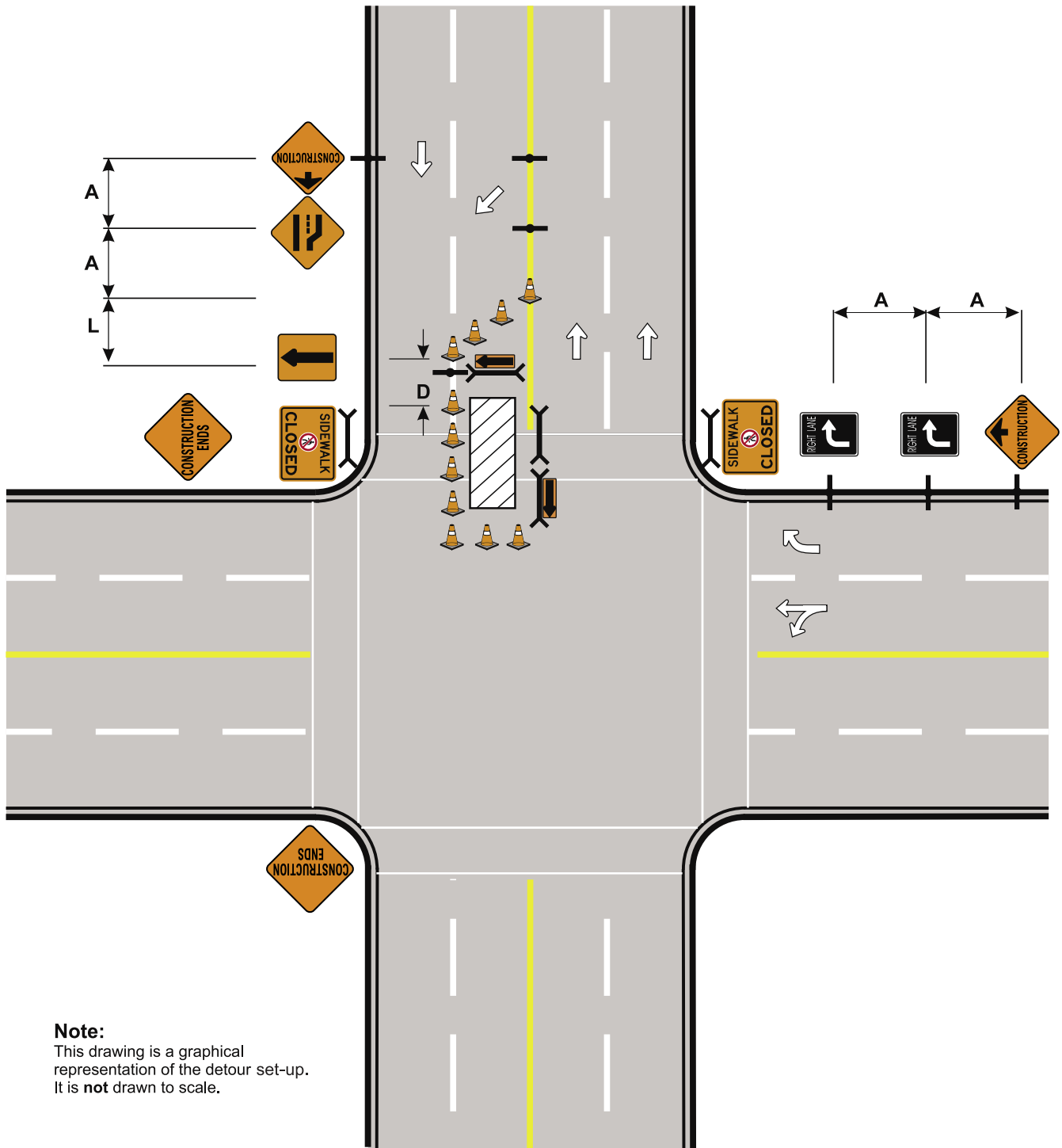

Note:
This drawing is a graphical representation of the detour set-up. It is **not** drawn to scale.

7.4 Intersection work – Example 4

1. Example shown

Four-legged intersection. Two approach lanes in all directions.

2. Conditions

Single mandatory right-lane condition.

Single mandatory left-lane condition.

3. Observations

Protect workers during set-up with traffic control persons.

Crosswalk closure.

4. Set-up procedure

Set up advance warning signs in order shown at top of diagram.

Set up advance warning signs and taper in order shown left side of diagram.

Post traffic control persons to protect workers.

Outline worksite with cones and barricades.

Commence work.

7.4 Intersection work – Example 4

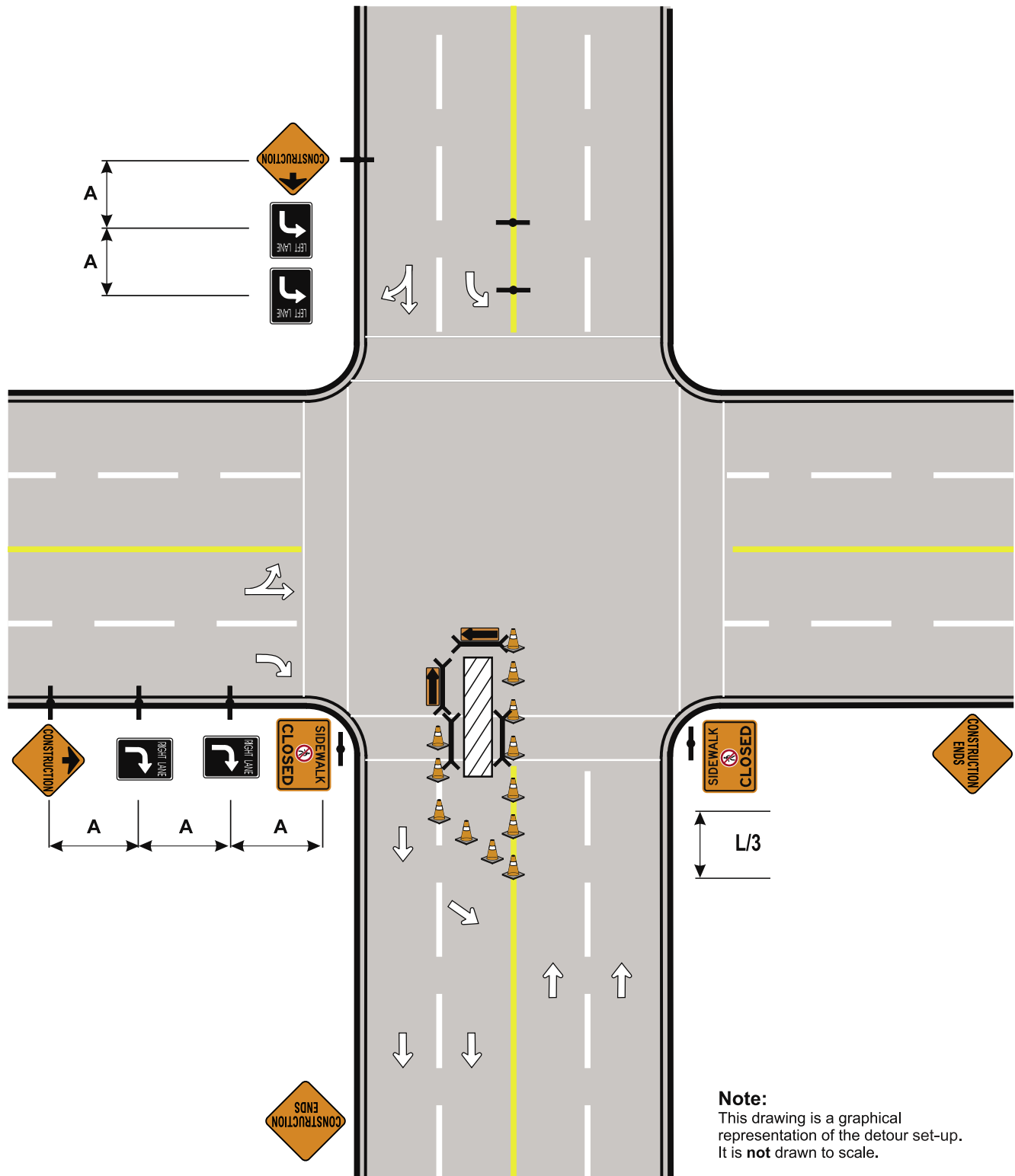

7.5 Intersection work – Example 5

1. Example shown

Four-legged intersection. Two approach lanes all directions.

2. Conditions

Two lanes closed in one direction.

Single-lane closure in opposing direction.

3. Observations

Use traffic control persons to protect workers during set-up.

Crosswalk closure.

4. Set-up procedure

Start at the bottom and the right side of the diagram. Set up single-lane closure in order shown (except cones and signs in intersection). Set up mandatory right-lane condition. Install two-way traffic signs to top right of diagram.

Start at top of diagram. Set up closure in order shown.

Post traffic control persons to protect workers during set-up.

Set up cones and signs in intersection.

Commence work.

7.5 Intersection work – Example 5

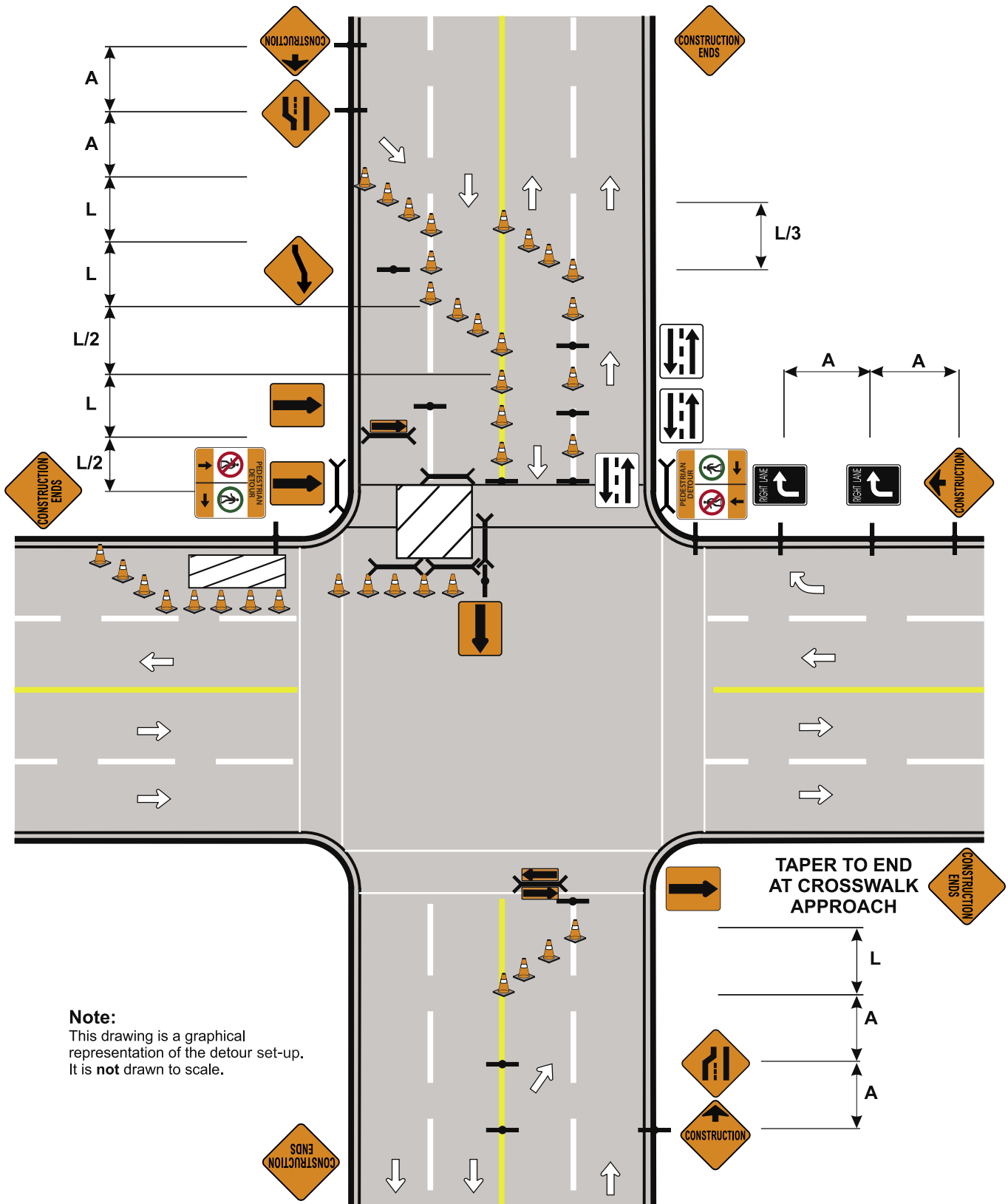

7.6 Intersection work – Example 6

1. Example shown

Four-legged intersection. Two approaching lanes in all directions.

2. Conditions

Two-lanes closed in one direction.

Single-lane closed in two directions.

3. Observations

Use traffic control persons to protect workers during set-up.

4. Set-up procedure

Start at the top left of the diagram. Set up advance warning signs in order shown.

Start at the bottom and the left side of the diagram. Set up single-lane closures in order shown (except for cones and signs in intersection).

Post traffic control persons to protect workers during set-up.

Set up signs in intersection.

Outline work area with cones.

Commence work.

7.6 Intersection work – Example 6

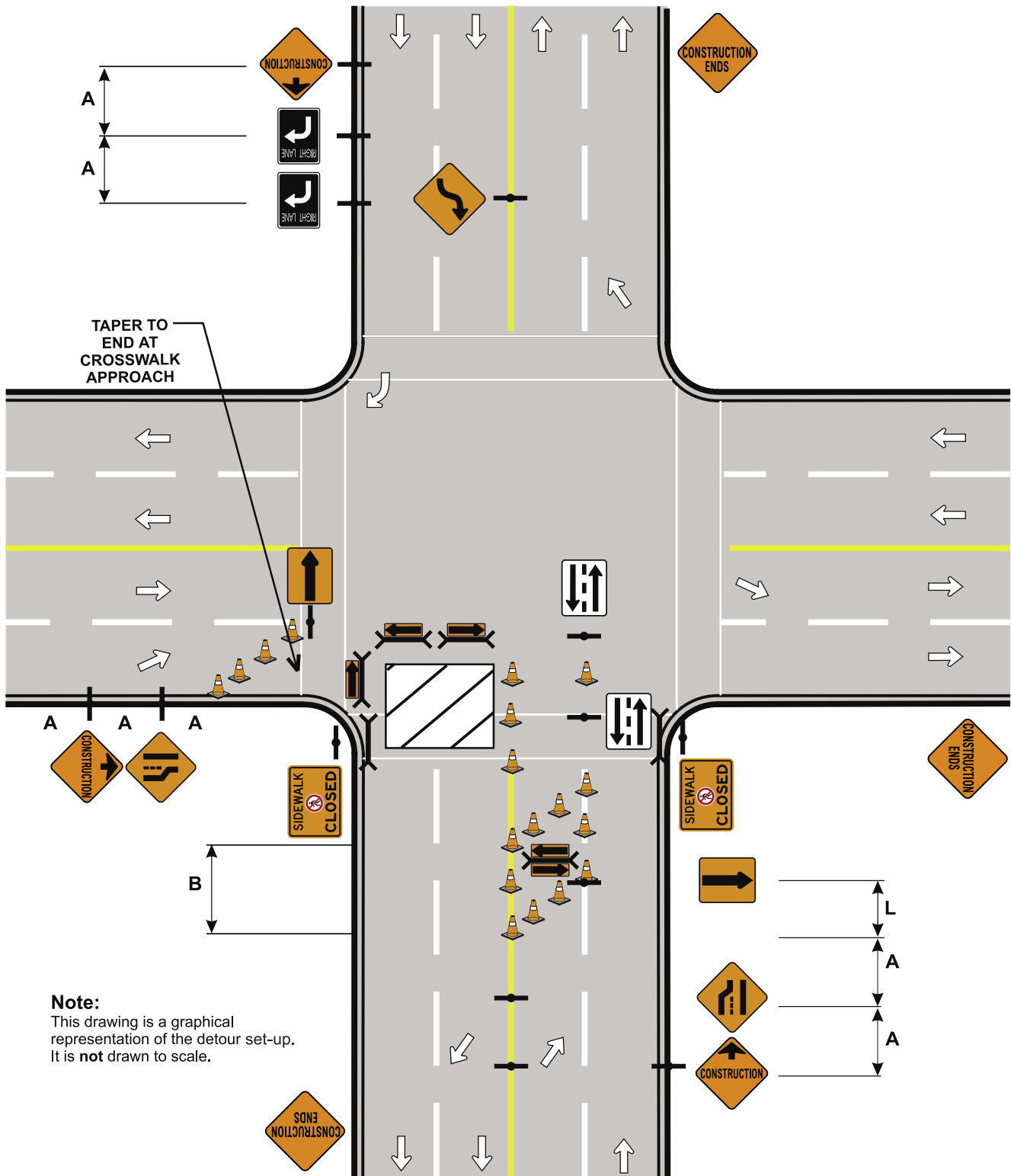

7.7 Intersection work – Example 7

1. Example shown

Four-legged intersection. Two approach lanes in all directions.

2. Conditions

Single-lane closure.

Introduction of left- or right-turn lanes.

3. Observations

Protect workers during setup with traffic control persons.

Lane closure introduced to remove a forced left or right turn lane.

4. Set-up procedure

Set up advance warning signs in order shown from bottom of diagram.

Set up Lane Closure Arrow sign.

Outline worksite with cones and barricades.

Commence work.

7.7 Intersection work – Example 7

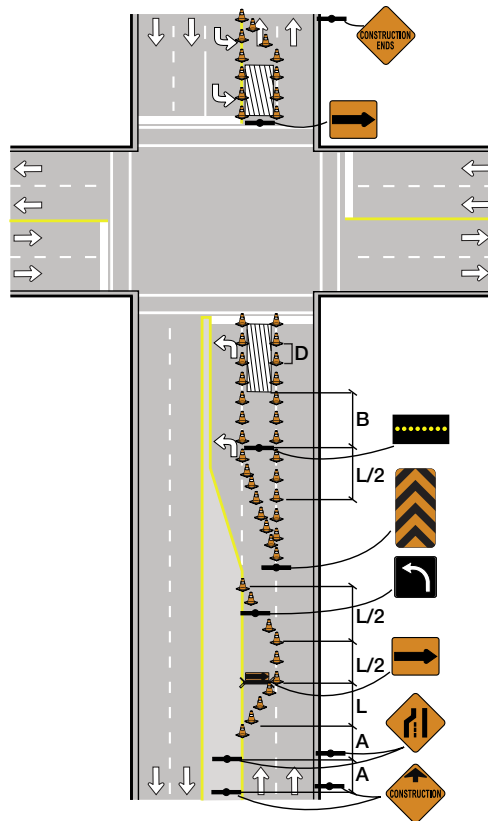
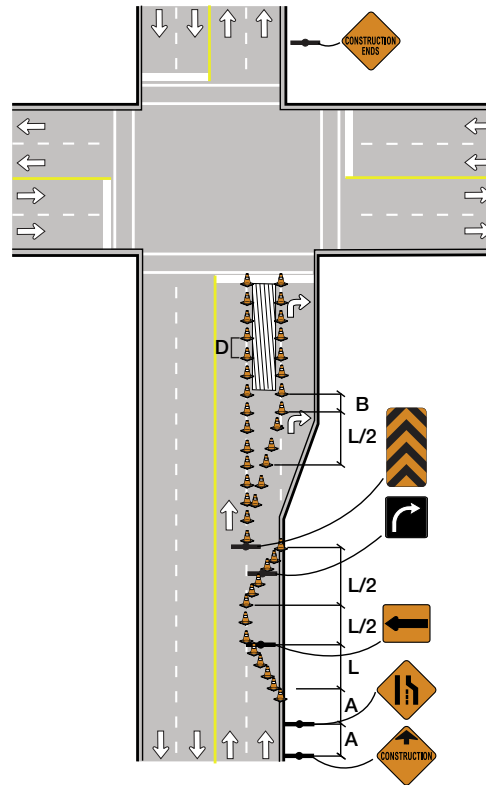

8.1 Back lane closure

1. Example shown

Residential back lane.

2. Conditions

One complete closure.

Partial alley closed.

3. Observations

Construction markers and flashers to be used at night and during periods of inactivity.

4. Set-up procedure

As shown.

8.1 Back lane closure

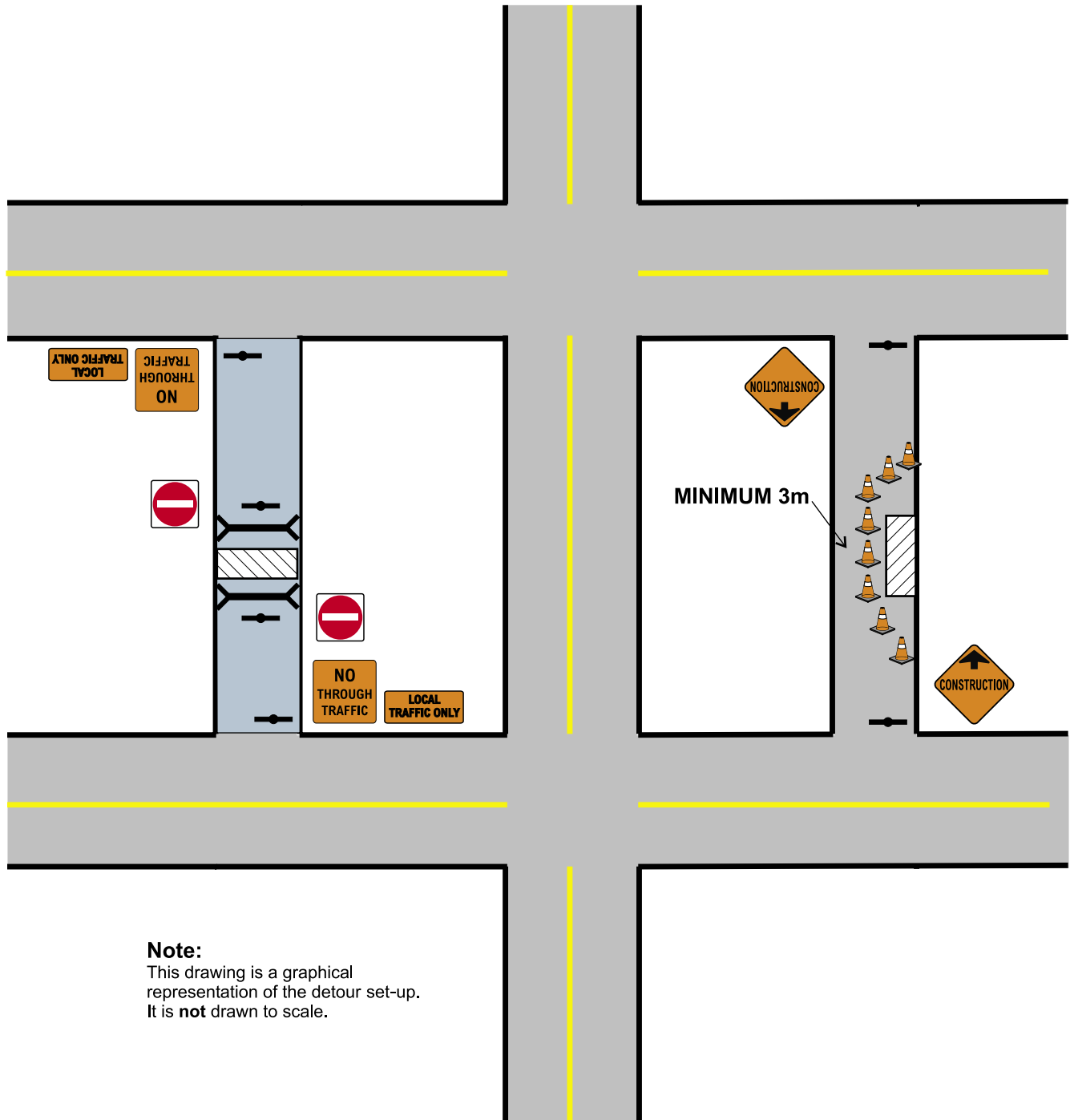

Note:
This drawing is a graphical representation of the detour set-up. It is **not** drawn to scale.

8.2 Road closure

1. Example shown

Two-lane – two-way street.

2. Conditions

Complete road closure.

Detour to adjacent streets.

3. Observations

Note detour signs show direction throughout traffic control zone.

Note closure of adjacent streets.

4. Set-up procedure

Set up detour signs.

Set up all other signs. Close side streets.

Secure work area.

Commence work.

8.2 Road closure

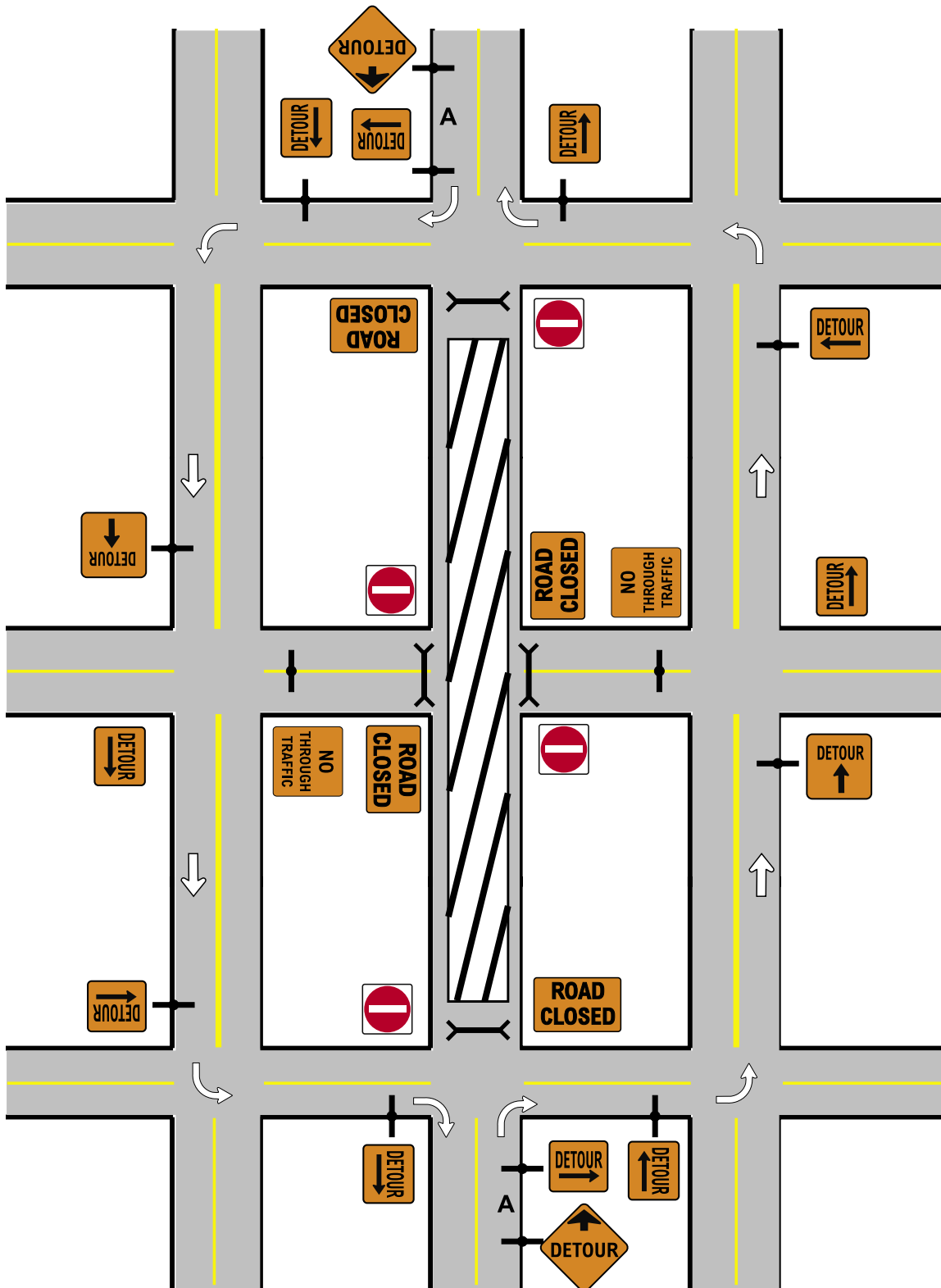

Note:
This drawing is a graphical representation of the detour set-up. It is **not** drawn to scale.

8.3 Cul-de-sac closure

1. Example Shown

Cul de sac.

2. Conditions

Complete road closure.

Local traffic only.

3. Observations

No parking sign maybe required.

Affected residents must be notified five business days before road is close and work commence.

4. Set-up procedure

Set up No Parking Zone first. Inspection by the Calgary Parking Authority 12 hours (minimum) prior to restriction.

Set up advance warning sign and No Through Traffic sign.

Install barricade to close the road.

Commence work.

8.3 Cul-de-sac closure

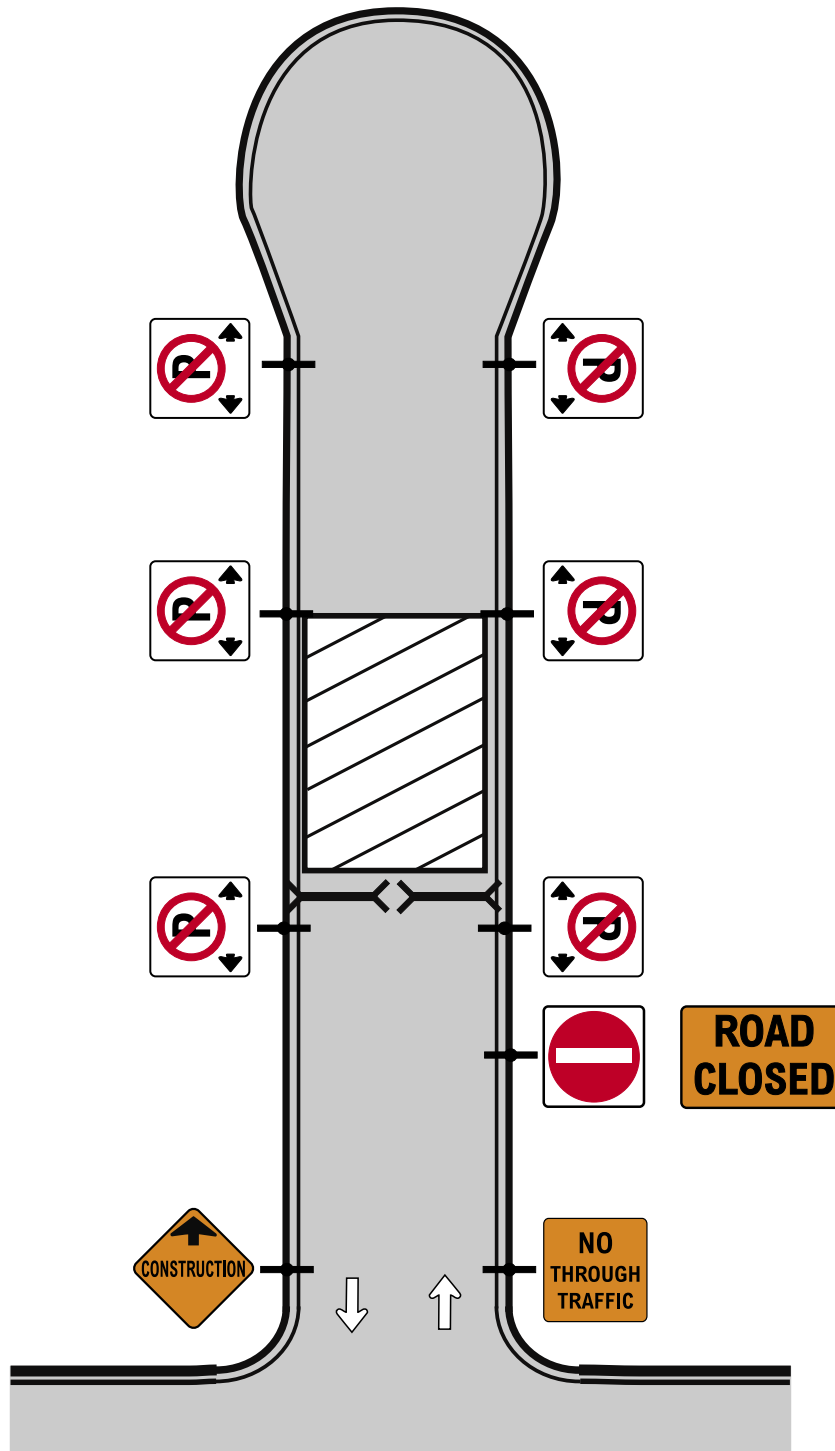

9.1 Sidewalk closure – Midblock (active site)

1. Example shown

Pedestrian detour.

2. Conditions

Pedestrians must be physically separated from vehicular traffic and the worksite.

3. Observations

Note barricades with continuous detectable edging at ground level to physically separate pedestrians from worksite. The barricades must be continuous, stable and non-flexible (rigid).

Sidewalk Closed signs direct pedestrians to alternative sidewalk.

With an active site, construction vehicles are typically adjacent to the sidewalk closure, making a pedestrian detour onto the adjacent roadway less feasible.

4. Set-up procedure

Co-ordinate with other work in the area to ensure that the sidewalk on the opposite side of the road will be available for pedestrian use for the duration of the proposed sidewalk closure.

Set up Sidewalk Closed signs and barricade worksite.

Commence work.

9.1 Sidewalk closure – Midblock (active site)

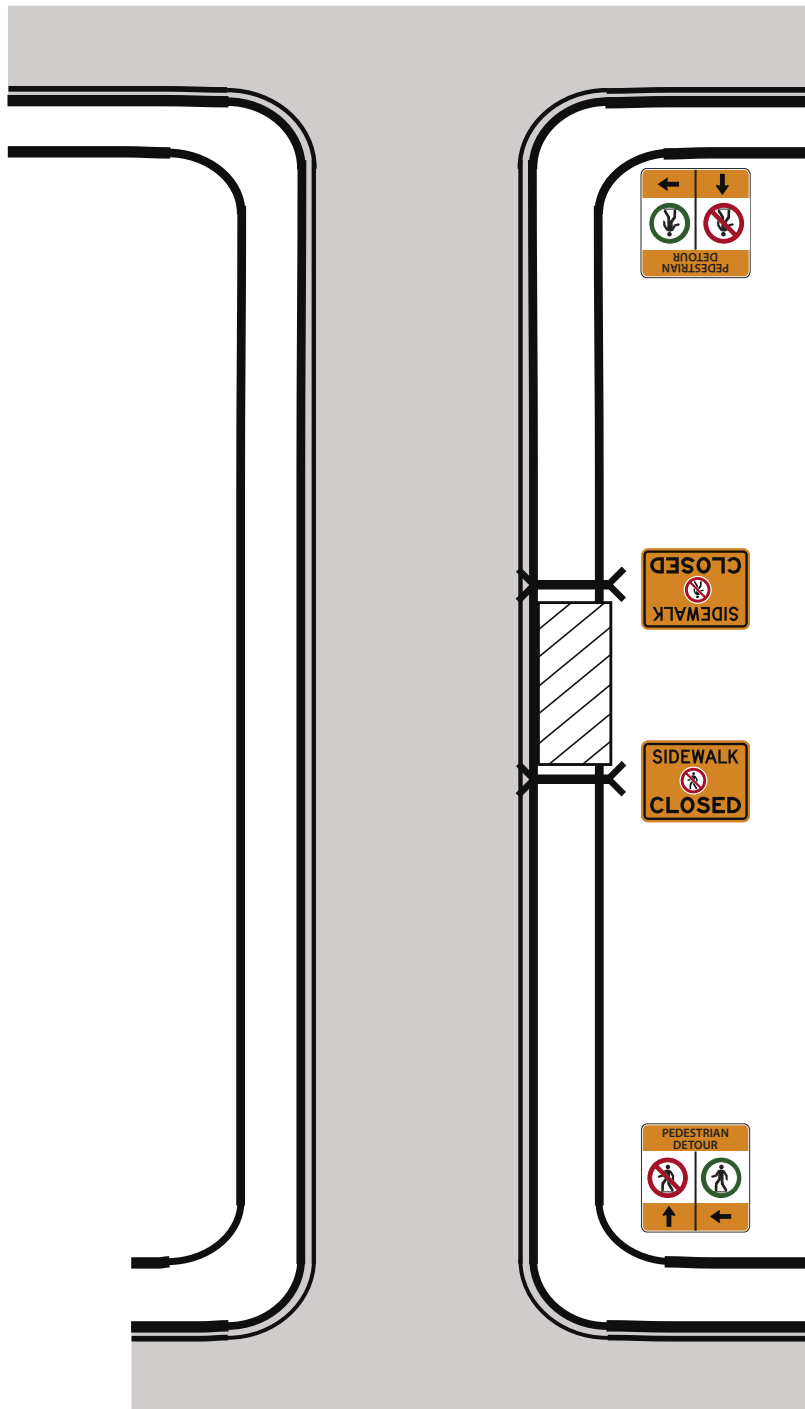

9.2 Sidewalk closure – One-way midblock (idle site)

1. Example shown

Pedestrian detour on residential roadway with no lane lines.

2. Conditions

Pedestrians must be physically separated from vehicular traffic and the worksite.

3. Observations

Note barricades with continuous detectable edging at ground level to physically separate pedestrians from worksite. The barricades must be continuous, stable and non-flexible (rigid).

Temporary ramps from the sidewalk surface to the roadway surface are recommended for wheelchair access.

Pedestrian Detour signs direct pedestrians around the worksite.

With an idle site, construction vehicles are not present adjacent to the sidewalk closure, making a pedestrian detour onto the roadway more feasible.

4. Set-up procedure

Co-ordinate with other work in the area to ensure that the sidewalk on the opposite side of the road will be available for pedestrian use for the duration of the proposed sidewalk closure.

Set up Sidewalk Closed signs and barricade worksite.

Commence work.

9.2 Sidewalk closure – One-way midblock (idle site)

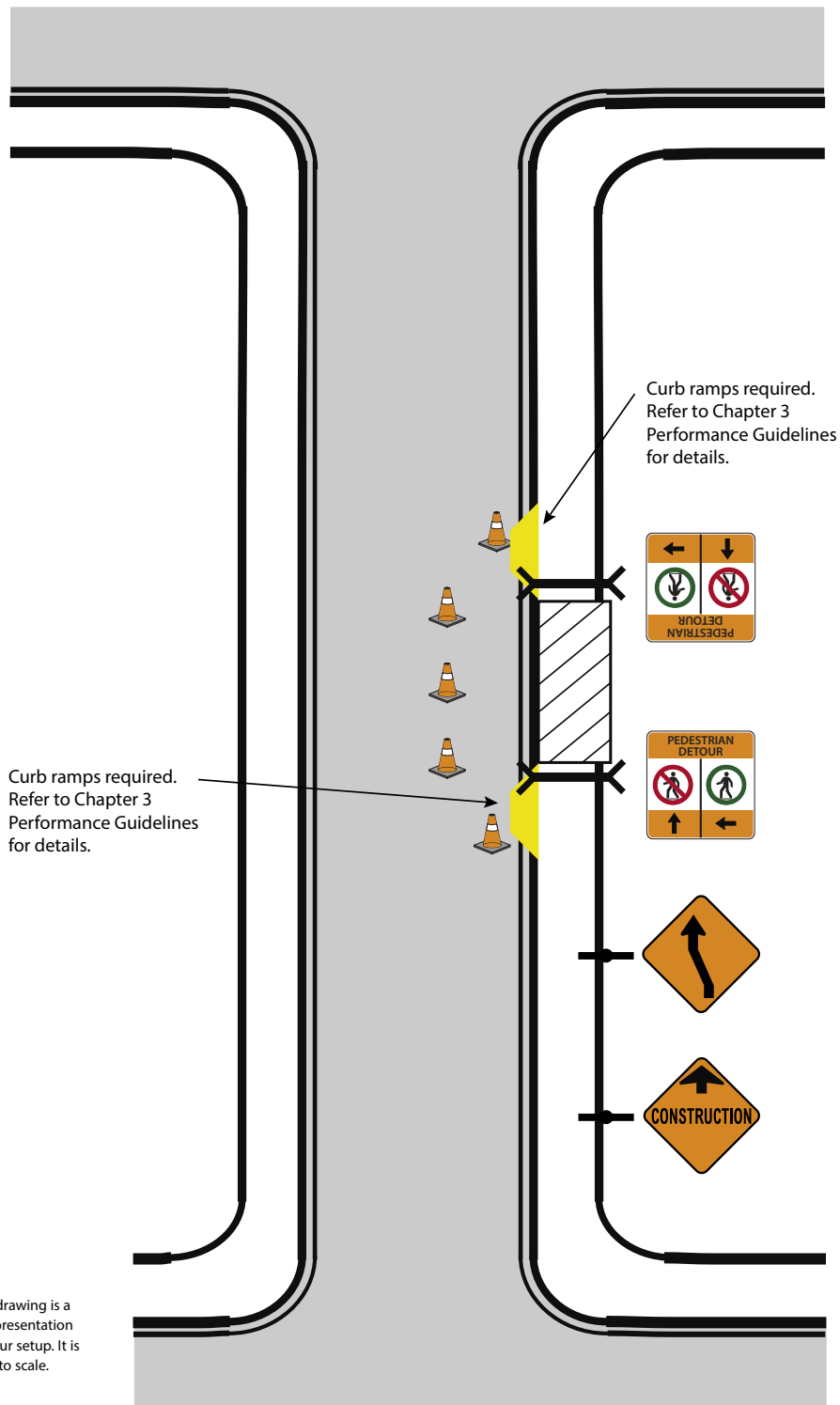

Note: This drawing is a graphic representation of the detour setup. It is not drawn to scale.

9.3 Sidewalk work – Intersection corner (active site)

1. Example shown

Intersection of two four-lane – two way roads in an area with a grid-style road network and sidewalks.

2. Conditions

Sidewalk closure diverts pedestrians with a marked detour route.

3. Observations

Note barricades with continuous detectable edging at ground level to physically separate pedestrians from worksite. The barricades must be continuous, stable and non-flexible (rigid).

Sidewalk Closed signs direct pedestrians to alternative sidewalk.

With an active site, construction vehicles are typically adjacent to the sidewalk closure, making a pedestrian detour onto the adjacent roadway less feasible.

4. Set-up procedure

Co-ordinate with other work in the area to ensure that the sidewalk on the opposite side of the road will be available for pedestrian use for the duration of the proposed sidewalk closure.

Set up Sidewalk Closed signs and barricade worksite.

9.3 Sidewalk work- Intersection corner (active site)

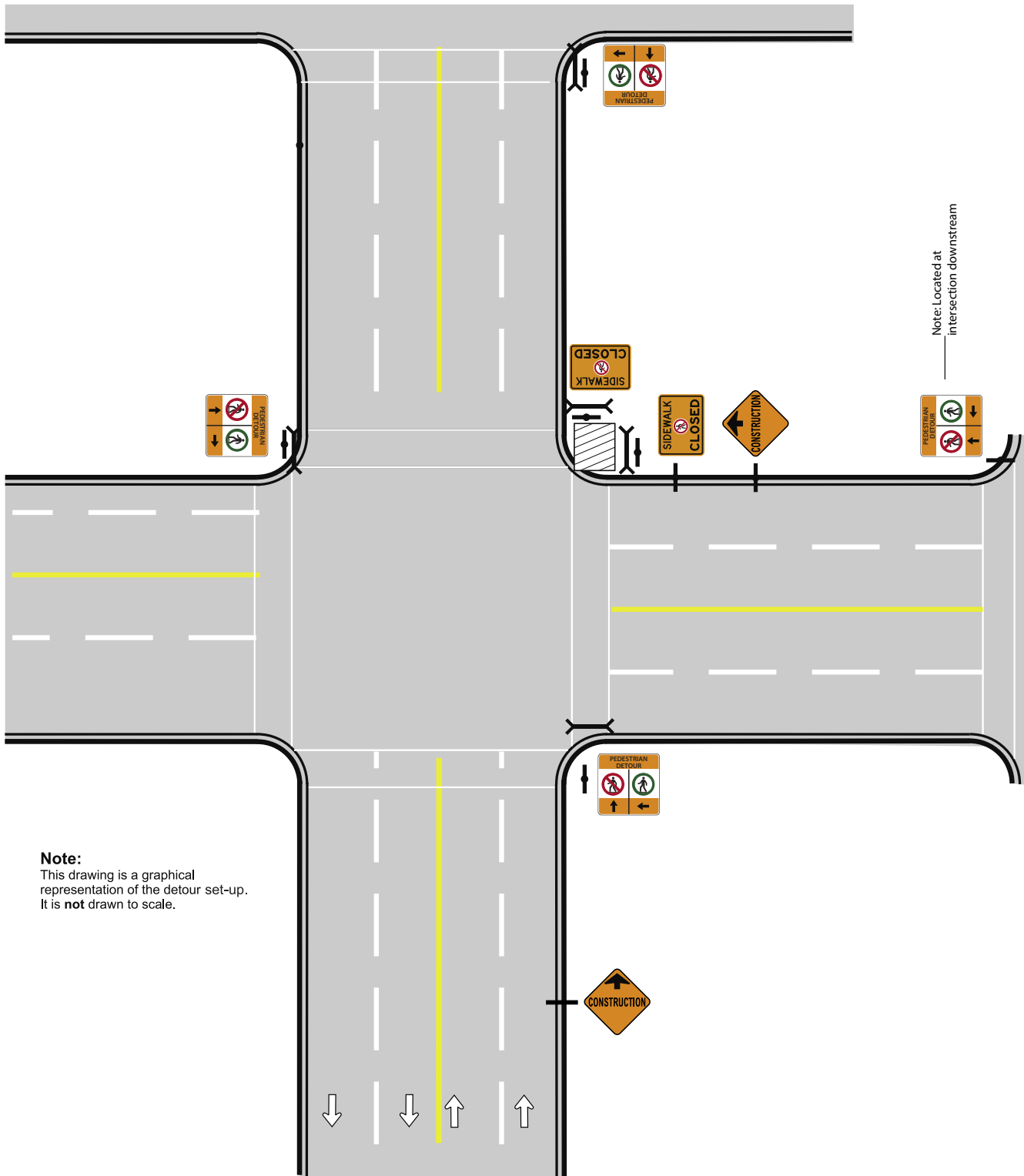

9.4 Sidewalk work – Intersection corner (idle site)

1. Example shown

Intersection of four-lane, two way roads in an area with a grid-style road network and sidewalks.

2. Conditions

Sidewalk closure diverts pedestrians into roadway, resulting in two closed lanes of traffic, close lanes as per the Temporary Traffic Control Manual 2021 (generally suitable during off-peak hours).

3. Observations

Note barricades with continuous detectable edging at ground level to physically separate pedestrians from worksite. The barricades must be continuous, stable and non-flexible (rigid).

Traffic cones can be replaced with temporary fencing or other temporary barriers to improve pedestrian safety (if deemed necessary).

Temporary ramps from the sidewalk surface to the roadway surface are recommended for wheelchair access.

4. Set-up procedure

Set up advance warning signs at bottom and right side of the diagram following the order shown.

Set up temporary pedestrian walkway with cones and/or barriers.

9.4 Sidewalk work- Intersection corner (idle site)

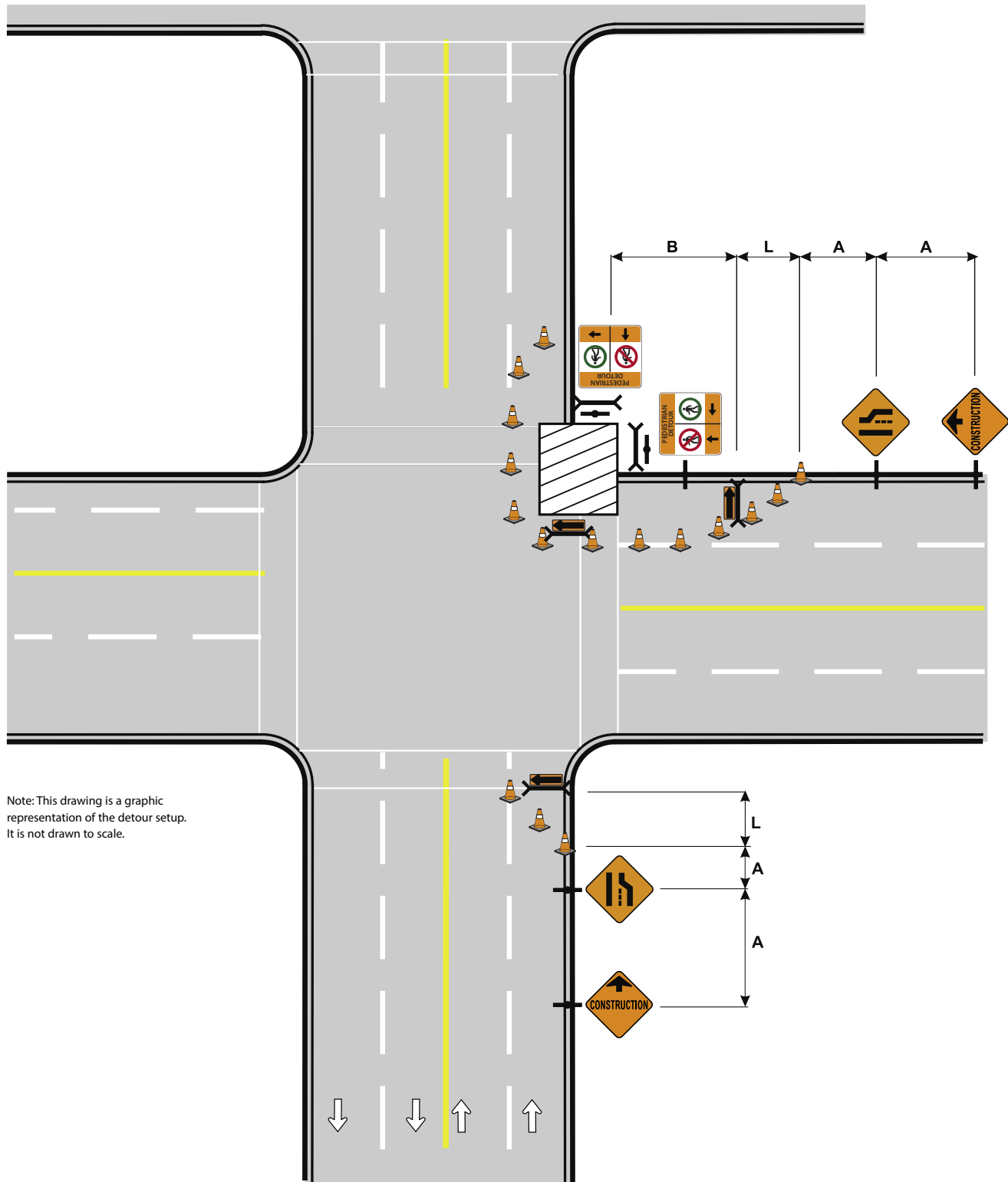

9.5 Sidewalk work – Right lane closure

This type of closure should be for short term use only. Concrete jersey might be needed for long duration work.

1. Example shown

Four-lane – two way street with sidewalk.

2. Conditions

Sidewalk closure diverts pedestrians to the right lane, closing this lane to vehicular traffic. This is for short-term work only. If closure is in place long-term, temporary barriers are required to separate pedestrians and vehicles.

3. Observations

Traffic cones can be replaced with temporary fencing or other temporary barriers to improve safety (if deemed necessary).

Temporary ramps from the sidewalk surface to the roadway surface are required for wheelchair access.

4. Set-up procedure

Start at the bottom of diagram. Set up advance warning signs in order shown.

Set up taper and temporary pedestrian walkway with cones and/or barriers.

Commence work.

9.5 Sidewalk work – Right lane closure

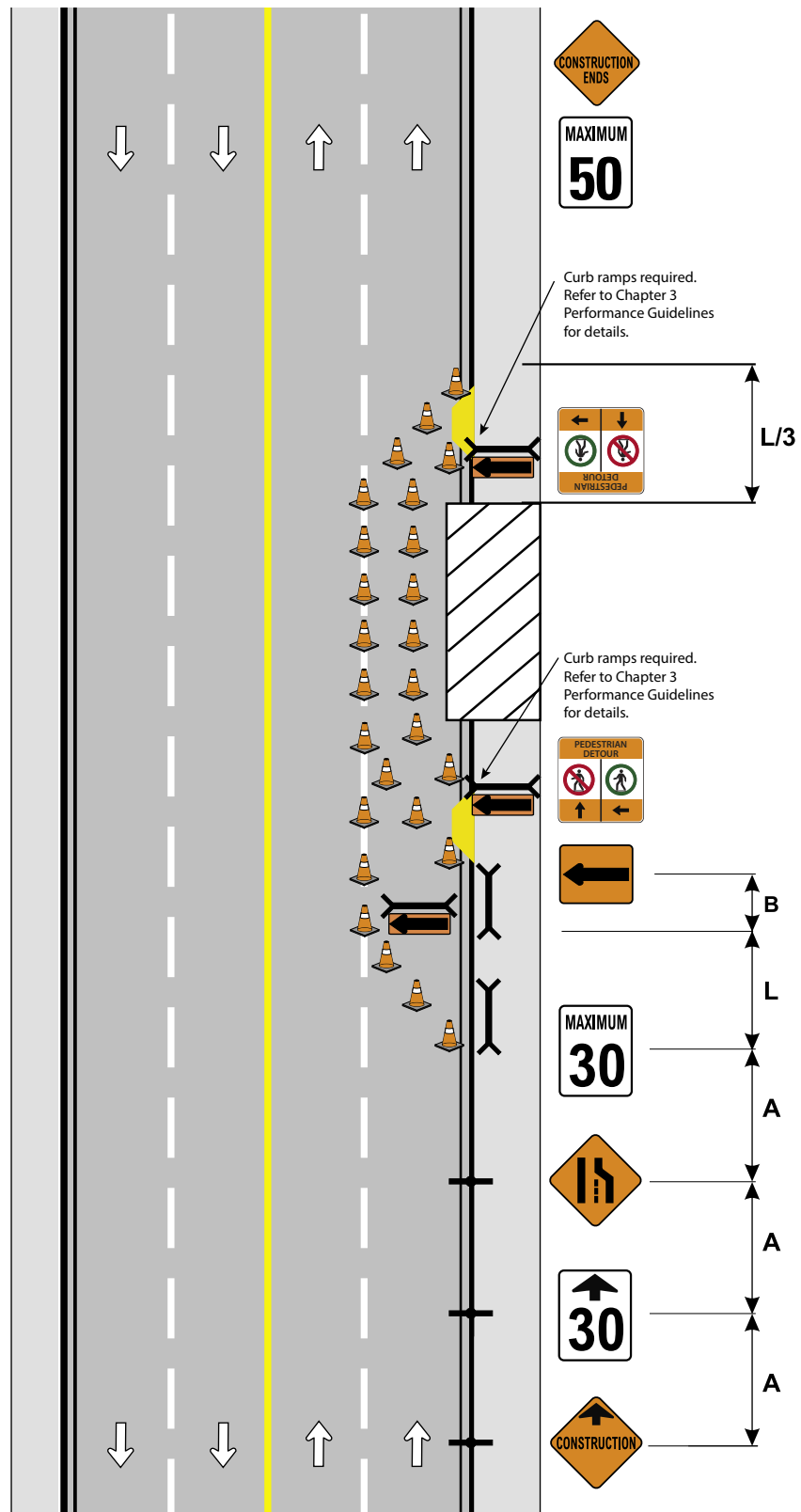

Note:
This drawing is a graphical representation of the detour set-up. It is **not** drawn to scale.

9.6 Sidewalk work – Partial sidewalk closure

1. Example shown

Four-lane – two way street with sidewalk.

2. Conditions

Partial sidewalk closure restricts sidewalk width but allows pedestrians to remain on the sidewalk.

3. Observations

Remaining sidewalk width must be greater than the minimum of 1.5 m.

There must be barricades with continuous detectable edging at the ground level to physically separate pedestrians from the work site. The barricades must be continuous, stable and non-flexible (rigid).

4. Set-up procedure

Start at the bottom of diagram. Set up advance warning signs in order shown.

Set up taper and outline work site with cones/barriers.

Commence work.

9.6 Sidewalk work – Partial sidewalk closure

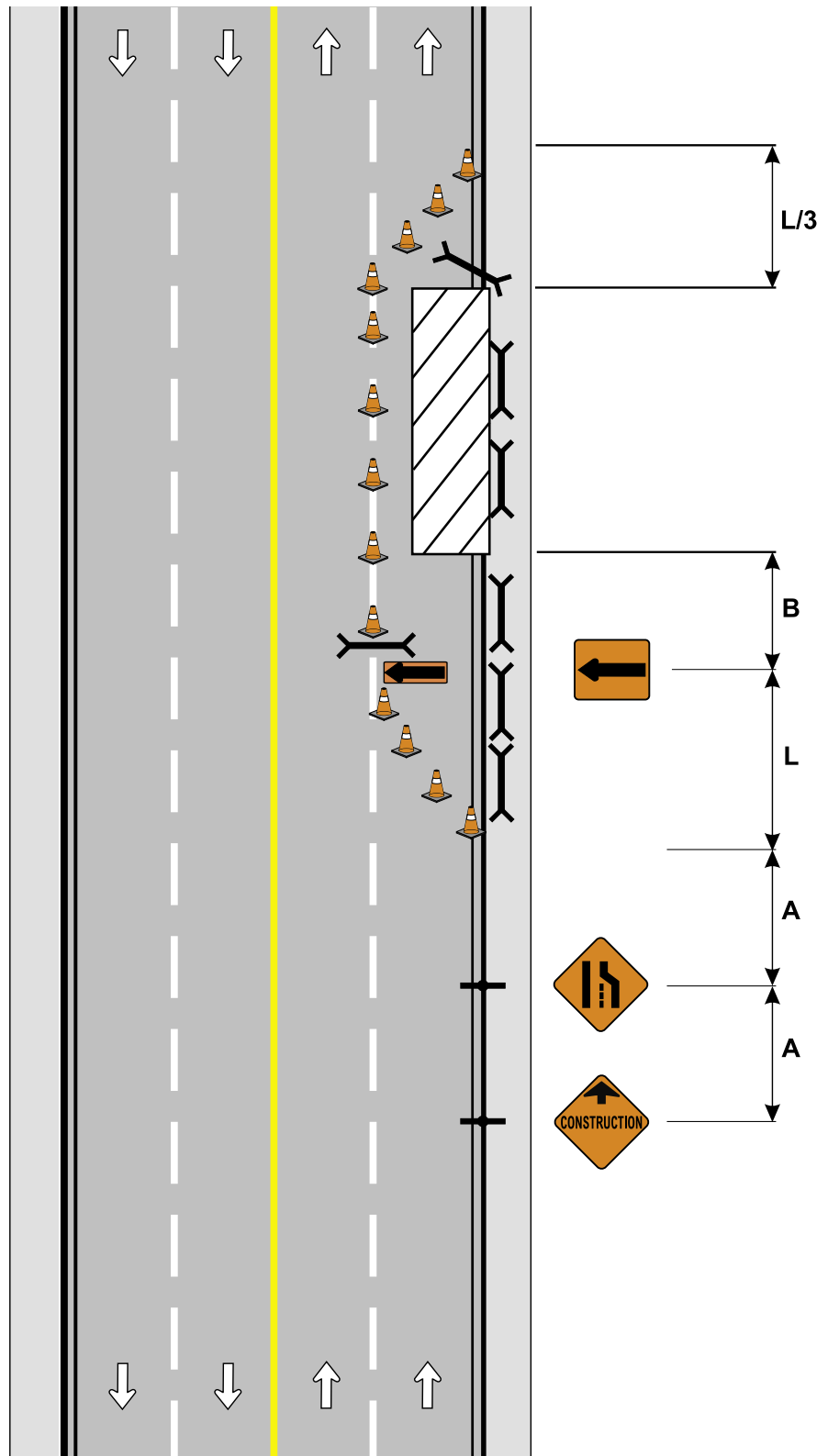

Note:
 This drawing is a graphical representation of the detour set-up. It is **not** drawn to scale.

10. Road bridging

1. Example shown

Three-lane – one-way street.

2. Conditions

Bridging to be installed for rush hour traffic and during periods of inactivity. Bridging to be designed, authenticated and an engineering drawing submitted to traffic for approval. Speed reduction may be required as per design plan.

3. Observations

Note bump sign.

Refer to Chapter 3 on bridging requirements (page 13).

Note temporary hazard markers.

4. Set-up procedure

All signs to be in place before vehicle traffic allowed on bridging.

10. Road bridging

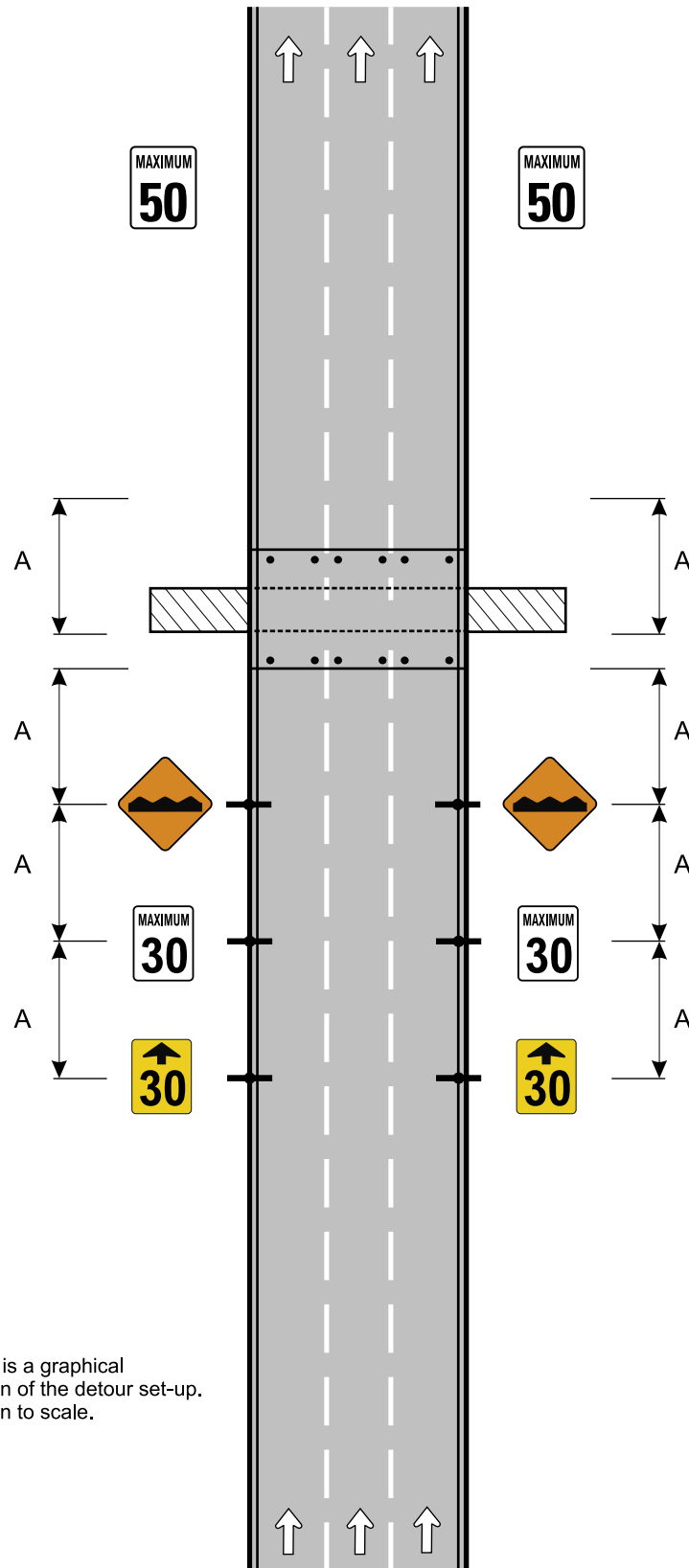

Note:
This drawing is a graphical representation of the detour set-up. It is **not** drawn to scale.

11. Roundabouts, Cycle Track Closure, Bike Lane, Shared Use Bike Lane

For work on or near any roundabouts or bicycle facilities, please contact The City of Calgary Traffic Division to provide temporary traffic control.

Chapter 6 – Incident/emergency procedures

Guidelines for The City of Calgary personnel

This section is a guide for any employee's response to an emergency. Examples of emergency situations are:

1. Collisions.
2. Roadway obstructions (debris on road).
3. Water pooling on roadway, sink hole or undermined pavement.
4. Dangerous goods/hazardous materials incidents.
5. Emergency work affecting Calgary Transit.

Contact Traffic Management Centre (101 Dispatch) at 403-268-4066.

Note: If pedestrian/cyclist facilities are impacted, close and immediately contact the Traffic Division to provide temporary traffic control plan.

Collisions

In all cases:

1. Pull over to shoulder and assess the situation.
2. Notify Emergency Services immediately by calling 911.
3. Notify 101 Dispatch at 311. Give details of exact location, and number of traffic lanes affected.
4. Protect the collision site.
 - Approach collision site with arrow board or beacon and/or four-way flashers activated.
 - Slowly come to a stop 40 metres in advance of the collision site. Set emergency brake.
 - Leave the vehicle when it is safe to do so. Ensure you are wearing all required personal safety equipment.
 - Assist at collision scene as much as possible, but do not put yourself knowingly at risk in traffic.
 - If the collision involves injuries, leave the scene undisturbed.
 - Do not move injured people off the road unless they are at risk from traffic or fire.
 - When emergency personnel arrive, follow their instructions.
 - Protect the site for all road users.

Roadway obstructions (i.e., debris)

In all cases:

1. Pull over onto the shoulder nearest to the obstruction.
2. Notify 101 Dispatch (311) immediately for emergency lane closure.
3. Give details of exact location, type and size of obstruction/debris, and how many lanes are affected.
4. Do not attempt to remove obstruction/debris. Qualified personnel will arrive to remove it.
5. Do not use your vehicle to close off lanes of traffic.
6. If there is obvious danger to the public, remain on site. Warn oncoming traffic in advance of the obstruction, from the shoulder of the roadway nearest to the obstruction.
7. Wear all personal safety equipment.

Water pooling on roadway, sink hole or undermined pavement

In all cases:

1. Pull over onto the shoulder.
2. Notify 101 Dispatch (311) immediately for emergency lane closure and to notify Water Services.
3. Give details of exact location and how many lanes are affected.
4. Do not use your vehicle to close lanes of traffic.
5. If there is an obvious danger to the public, remain on site.
6. Stop vehicle before the location, in a way that will provide motorists with advanced notice of the situation.
7. Wear all personal safety equipment.

Potential dangerous goods/hazardous materials incidents

In all cases:

1. Approach the scene from uphill and upwind when hazardous materials are suspected.
2. Identify placards, signage or container shape, from a distance, prior to close proximity approach.
3. Avoid direct contact with the product and its vapours.
4. Once involved products are identified, notify the Fire department (Hazardous Materials Response Team) and Police immediately at 9-1-1 or through 101 Dispatch (311). Give the UN number of product, exact location, nature of the incident (if possible), and number of lanes affected.
5. Use your vehicle to close traffic lanes from a safe distance. The product involved and research information provided by the dispatcher or 9-1-1 operator will determine this distance.
6. Warn traffic in advance, from the shoulder nearest the site. Activate arrow board or beacon and/or four-way flashers.
7. Leave the vehicle immediately, wearing all personal safety equipment and find a safe place to wait away from the contaminated area.
8. When emergency personnel arrive, follow their instructions.

Note: certain chemicals are extremely hazardous. Always stay upwind from the incident site and never put yourself or others at risk.

Emergency work affecting Calgary Transit

Contact the Co-ordinator of Operations 24 hours a day/7 days per week at 403-268-1422. Alternate numbers for the Co-ordinator of Operations are 403-268-1517 or 403-268-1518.

Procedures for trained personnel assigned to emergency incidents

A foreman shall be assigned to each emergency situation requiring longer than 15 minutes to restore to normal conditions.

The foreman must report to the incident commander on arrival at the incident for briefing of existing emergency traffic management and future objectives. All agencies in attendance must be aware that the contractor is on scene and included in developing a plan for the takeover of traffic accommodation.

The assigned foreman will remain on site at all times until normal conditions are resumed or a full traffic set-up is in place.

It shall be the responsibility of the assigned foreman to observe traffic flow around the work area. If a hazard becomes apparent, the foreman and supervisor must take appropriate action to maintain safe working conditions.

This may include removing workers and/or equipment from the road until a full traffic set-up is in place.

Emergency response set-up

- The number of arrow boards dispatched is determined by the number of lanes to be closed plus one arrow board for advance warning.
- A full traffic set-up shall be requested immediately if normal conditions can not be resumed in one hour. Length of time involved must be determined within the first 15 minutes at the site.
- This set-up will be maintained or upgraded until a full traffic set-up is in place or normal conditions are resumed.

Additional protective measures

For emergency set-ups of one hour or more, or as traffic conditions warrant, it is expected that additional measures be taken. These measures increase visibility and safety at the worksite.

These measures are over and above the accepted minimum for emergency set-ups. Any or all are acceptable.

1. Flag traffic right or left from the shoulder in advance of the shoulder arrow board. This is most effective when two or more lanes have been closed or when the worksite is located around a curve. Use approved safety apparel and traffic control paddles.
2. If it can be done safely, cones may be set up in the traffic control zone. One or both of the following is acceptable:
 - Set up cones along the skip line between each arrow board. This will prevent motorists from changing lanes in the wrong direction.
 - Set up cones across closed traffic lanes beside each arrow board. This will identify closed traffic lanes for the motorist.
3. Although a full traffic set-up may not be necessary, the Traffic Division can supply traffic control devices for a partial set-up. Call the Division at 311 (office hours) or 101 Dispatch, 311 (after hours).
4. Have the traffic control zone sanded in slippery conditions. Call 101 Dispatch 311.
5. Trailer-mounted message boards and arrow boards are available by calling Traffic Field Operations. Call 311 (office hours) or 101 Dispatch 311 (after hours).

Calgary Police Service can supply units to close traffic lanes or increase job site visibility. Call 101 Dispatch at 311. 101 Dispatch will contact CPS.

Note: This measure shall only be taken when all other measures fail to provide safe working conditions.

Glossary

Acceleration lane

A lane that enables vehicle to increase speed when merging with through traffic.

Activity area

The activity area is the section of roadway where the work activity takes place. It is comprised of the work space and the traffic space, and may contain one or more buffer spaces.

Advance warning area

In the advance warning area, drivers are informed of what to expect in the downstream workzone or incident area.

Advance warning signs

Signs that give motorists and pedestrians advance notice of disruptions in normal traffic flow. These signs indicate the nature of traffic disruption and the required action on the part of motorists and pedestrians.

Agency or contractor

Any City department, private contractor or public utility agency that has permission and necessary permits to undertake work on, or adjacent to, City of Calgary public roadways.

Arrow displays or arrow boards

Flashing arrow displays/boards are traffic control devices that can provide an illuminated flashing display of a left arrow, a right arrow or combination of the left-right arrow, sequencing arrow modes or a bar, which inform the driver to either change lanes or proceed with caution. An arrow display/board shall be used in combination with the appropriate signs, barricades or other traffic control devices.

Arterial

A road primarily for through-traffic.

Auxiliary lane

A lane in addition to and placed adjacent to a through-lane.

Average daily traffic (ADT)

The total volume of traffic passing a designated point, in both directions, in one day.

Bike lane

A lane intended for the exclusive use of bicycles, within a roadway used by motorized vehicles.

Breakaway device

A design feature that allows a device such as a sign to yield or separate upon impact.

Bridging

A method to enable vehicles to pass over narrow and shallow trenches by fastening sheet steel to the roadway to form a bridge. It is used at peak congestion times to accommodate traffic when backfilling is not practical.

Buffer space

The buffer space is the area that separates traffic flow from the work activity or a potentially hazardous area and provides recovery space for an errant vehicle. Neither work activity nor storage of equipment, vehicles or material should occur in this space. Buffer spaces may be positioned longitudinally and laterally, with respect to the direction of traffic flow.

Buffer vehicle

A vehicle positioned in a stationary workzone or in a mobile work operation, to provide protection for workers against errant vehicles (also referred to as a shadow vehicle). These vehicles should be equipped with an arrow display/board and a truck-mounted attenuator.

Collector road

A road in which access and traffic movement have similar importance.

Crosswalk

Any part of a roadway specifically intended for pedestrian crossing, which may be so indicated by signs, lines, markings or other devices.

Cyclist

A person riding any cycle, propelled by human effort or a power-assisted device. Once a cyclist dismounts, he/she is considered a pedestrian.

Decision sight distance (DSD)

The distance for a driver to detect a layout, recognize it and maneuver safely.

Delineation devices (or tapering devices)

Devices used to form curves, lines or boundaries that indicate the alignment of the roadway and outline the required vehicle path through the temporary traffic control zone. They include, but are not limited to, cones, drums, tubular markers, barricades and chevrons, and shall be used in combination with or be supplemental to other traffic control devices.

Design speed

A speed selected for purposes of road design.

Detour

A detour is a temporary route where a driver, cyclist or pedestrian is required to depart completely from the normal roadway, sidewalk or pathway route to bypass the activity area.

Diversion

Traffic is directed onto a temporary roadway or alignment placed in or next to the ROW.

Downstream

The area past the TTC workzone in the direction of traffic flow.

Expressway

A divided arterial roadway for through traffic with full or partial control of access and with some interchanges. Posted speeds are typically less than or equal to 80 km/h.

Freeway

A multi-lane, divided highway with a minimum of two lanes for the exclusive use of traffic in each direction and full control of access without traffic interruption. Posted speeds are typically greater than or equal to 90 km/h.

Gore area

An area of pavement delineated by paint lines or delineation devices, between the edge line of the through road and the entry or exit ramp.

Hoarding

A form of fencing or barrier or combination of these, designed to separate pedestrians and/or motorists from a construction site.

Impact attenuators

A device (also known as crash cushions) that prevents an errant vehicle from impacting a fixed object by safe, controlled deceleration. Impact attenuators in temporary traffic control zones protect motorists from the exposed ends of barriers, fixed objects and other hazards.

Intersection sight distance (ISD)

The line of sight between intersecting roadways.

Lateral buffer space

A lateral buffer space is used to separate the traffic space from the work space, or a potentially hazardous area, such as an excavation or pavement drop-off. The width of the lateral buffer space should be determined by engineering judgement.

Longitudinal barrier

A barrier whose primary function is to prevent a collision and redirect an errant vehicle.

Longitudinal buffer space

The longitudinal buffer space is placed in the initial portion of a closed lane in advance of the work space.

May

A permissive condition.

Median

A reserve, including shoulders between through lanes.

Multi-use pathway

A bicycle and pedestrian facility, physically separated from roadways, where motor vehicle traffic, except maintenance vehicles, is excluded.

Normal posted regulator speed limit

This is the legislated roadway speed prior to temporary traffic zone conditions and is also referred to as gazetted speed.

On-street bike route

A roadway signed specifically to encourage bicycle use.

Pedestrian

A person walking or jogging, using a wheelchair or mobility aid, walking a dog, travelling with a child's stroller, in-line skates or a skateboard.

Regulatory sign

Signs used to identify a traffic regulation that is applicable at a given time or place on a road and to identify the legal requirements.

Rigid Barrier

A form of longitudinal barrier that is intended to redirect an errant vehicle with minimum deflection. It usually consists of a continuous concrete mass (i.e., a concrete, safety-shaped barrier, such as the New Jersey barrier).

Semi-rigid barrier

A form of longitudinal barrier intended to redirect an errant vehicle by rail tension and bending. Examples are the blocked W-Beam or Thrie-Beam.

Shall

A mandatory requirement.

Should

An advisory requirement.

Sidewalk

A travelled way intended for pedestrian use, following an alignment generally parallel to that of the adjacent roadway.

Stopping distance

The distance travelled by a vehicle from the instant the driver decides to stop until stopped.

Stopping sight distance (SSD)

The distance between vehicle and object for which the driver decides to stop, from the instant the object comes in view. This includes the distance travelled during perception and reaction times plus the braking distance.

Tangent

A straight section of roadway. In TTC set-ups it is the distance between the end of one taper and the beginning of the next.

Taper

The gradual narrowing of a lane using channelization devices, intended to safely guide drivers into the adjacent lane. The following identify various types of tapers used in temporary traffic control.

- **Merging taper**

A merging taper requires drivers to merge with an adjacent lane of traffic. The taper should be long enough to enable drivers to adjust their speeds and merge into a single lane before the end of the transition. A merging taper requires a full lane shift.

- **One-lane, two-way (traffic) taper**

The one-lane, two-way traffic taper is used where the portion of road is used alternately by traffic in each direction. These are typically used when traffic is controlled by traffic control persons.

- **Shifting taper**

A shifting taper is used where a lateral shift (not a full lane merge/diverge) is required and includes a parallel lane shift (lane encroachment) or a shoulder shift taper (shoulder encroachment).

- **Shoulder taper**

A shoulder taper can be used on roadways with improved shoulders that may be mistaken for driving lanes.

- **Termination (downstream) taper**

The downstream taper may be useful in termination areas to provide a visual clue to the driver that access is available to the original lane path that was closed.

Temporary traffic control (TTC)

Provides for the movement of vehicles, bicycles, pedestrian traffic and public transit, when the normal function of a roadway is suspended.

Termination area

Is used for traffic to make the transition back to the normal path of the road. It extends downstream from the end of the workspace to the point where normal speed resumes.

Traffic control person

A trained and certified person responsible for controlling traffic.

Transition area

The section of roadway where road users are redirected from their normal path.

Traffic control devices

Devices to direct vehicle and pedestrian movement through an area in which normal traffic flow has been disrupted. This includes all signs, delineators, barricades and arrow boards.

Traffic control zone

The zone where normal traffic flow is disrupted by guiding traffic around an obstruction. This zone includes the work area and all areas affected by temporary traffic control devices.

Transition area

When redirection of the driver's normal path is required, traffic must be channelled from the normal path to a new path. This redirection is intended to occur at the beginning of the transition area.

Truck mounted attenuator (TMA)

An energy-absorbing device mounted on the rear of a crash truck to deform on impact in a controlled manner.

Upstream

The area before the TTC workzone in the direction of traffic flow.

Variable message boards (portable changeable message signs)

Are traffic control devices with the flexibility to display a variety of messages.

Warning signs

Warning signs providing advance notice of conditions on or adjacent to a road that will normally require a reduction in speed.

Worksite or work area

The area around which traffic is being diverted to enable work to be done. It is usually bound on one or more sides by traffic control set-up. It includes an area for use of equipment, stockpiling materials and the excavation or building site.

Bibliography

The City of Calgary would like to acknowledge the following resource materials used in preparing this manual:

1. *A Guide to Temporary Traffic Control in Work Zones*, American Traffic Safety Services Association, 1998.
2. *Alberta Temporary Traffic Control Guidelines Training Manual*, Alberta Construction Safety Association and American Traffic Safety Services Association, 2000.
3. *Applying the Americans with Disabilities Act in Work Zones: A Practitioners Guide*, The American Traffic Safety Services Association, 2012.
4. *Bicycle Policy and Needs Report*, City of Calgary, 2008.
5. *Bikeway Traffic Control Manual*, Transportation Association of Canada, 1998.
6. *Design Bulletin #41/2006*, Alberta Transportation and Infrastructure, December 2006.
7. *Draft Guidelines for Accessible Public Rights-of-Way*, U.S. Access Board, 2005.
8. *Emergency Traffic Management*, Calgary Fire Department, 2002.
9. *Flagging Handbook*, American Traffic Safety Services Association.
10. *Flagpersons Handbook*, Alberta Transportation and Infrastructure.
11. *Flagperson Training Workbook*, The Alberta Construction Safety Association, 1996.
12. *Geometric Design Guide for Canadian Roads* (2017 Edition), Transportation Association of Canada.
13. Johnston, M., Morrall, J.F., and Swanson B. "An In-Service Operational Review of Current Temporary Traffic Control Practices in Calgary", Transportation Association of Canada, 2002.
14. *Manual on Uniform Traffic Control Devices* (Millennium Edition, December 2000), U.S. Department of Transport, Federal Highway Administration.
15. *Manual of Uniform Traffic Control Devices for Canada* (5th Edition), Transportation Association of Canada, 2014.
16. *Manual on Uniform Traffic Control Devices*, U.S. Department of Transportation, Federal Highway Administration, 2009.
17. *Pedestrian Policy and Needs Report*, City of Calgary, 2008.
18. *Procedures for On-Street Construction Safety* (2000 Edition), The City of Edmonton.
19. *Roadside Design Guide*, American Association of State Highway and Transportation Officials, 2002.
20. *Temporary Conditions*, Ontario Traffic Manual, 2014.
21. *Traffic Accommodation in Work Zones* (2nd Edition), Alberta Transportation and Infrastructure, 2018.
22. *Worksite Temporary Traffic Control Manual*, Engineering and Environmental Services Department, Transportation Department, The City of Calgary, 1991.
23. *Workzone Operations: Best practices Guidebook*, Federal Highway Administration (FHWA) and AASHTO, FHWA-OP-00-010, April 2000.
24. *Z96-15 Standard High-visibility safety apparel*, Canadian Standards Association, February 2016.

Appendices

Appendix A – Street Use Permit

Appendix B – Hoarding Permit

Appendix C – Record of Temporary Traffic Control (Inspection Form)

Appendix D – High Visibility Safety Apparel

Appendix E – Sign Sizing Guideline

Appendix F – Maximum Speed Ahead Sign Placement

Appendix G – Construction site contact info

Appendix A – Street Use Permit

STREET USE PERMIT APPLICATION REQUIREMENTS

In order to obtain a Street Use Permit the following must be submitted to the Traffic Engineering Department. Contact Traffic Engineering for specific requirements.

Street use information:

REQUIRED RECEIVED

- | | | |
|--------------------------|--------------------------|------------------------------------------------------------------------------------------------------------------------------|
| <input type="checkbox"/> | <input type="checkbox"/> | Reason for the street use. |
| <input type="checkbox"/> | <input type="checkbox"/> | Description of proposed street use. |
| <input type="checkbox"/> | <input type="checkbox"/> | Justification for the need of the street use. |
| <input type="checkbox"/> | <input type="checkbox"/> | Alternatives that were considered. |
| <input type="checkbox"/> | <input type="checkbox"/> | Complete schedule of planned street use, including start and end dates, hours of work and extent of street use at all times. |

Scaled engineering drawing(s) and notes detailing:

REQUIRED RECEIVED

- | | | |
|--------------------------|--------------------------|------------------------------------------------------------------------------------------------------------------------------------------------------|
| <input type="checkbox"/> | <input type="checkbox"/> | Extent of street use, including length, width and number of lanes, relative to existing curb, back of walk, property line and road markings. |
| <input type="checkbox"/> | <input type="checkbox"/> | Location of excavation with planned saw cuts and depth of excavation. |
| <input type="checkbox"/> | <input type="checkbox"/> | Proposed temporary traffic to be employed. |
| <input type="checkbox"/> | <input type="checkbox"/> | Site fencing and/or access control to protect public safety. |
| <input type="checkbox"/> | <input type="checkbox"/> | Removal and/or relocation of any existing traffic control devices, including signage, signals and parking metres (complete with associated numbers). |
| <input type="checkbox"/> | <input type="checkbox"/> | Pedestrian and bicycle accommodation (considering adults, public transit patrons, children and people with special needs). |
| <input type="checkbox"/> | <input type="checkbox"/> | Access for emergency vehicles. |
| <input type="checkbox"/> | <input type="checkbox"/> | Access to fire hydrants and water valves. |
| <input type="checkbox"/> | <input type="checkbox"/> | Parking of contractor and employee vehicles. |
| <input type="checkbox"/> | <input type="checkbox"/> | Method of plating to be employed during peak hours. |

Street Use Permit application requirements

Any special requirements, such as construction material or excavation material storage.

Other items:

REQUIRED RECEIVED

An alternative plan to open the roadway in the event of unexpected circumstances.

Confirmation that arrangements have been made for asphalt and planned timing such that the road will be open to traffic for peak period as defined by Traffic Engineering.

Copy of excavation permit.

Transit approval.

Traffic impact study.

Tree Protection Plan (refer to the Tree Protection Bylaw 23M2002).

Communication plan.

Appendix B – Hoarding Permit

HOARDING PERMIT APPLICATION REQUIREMENTS

In order to obtain a Hoarding Permit, please apply through e-permit. Contact Traffic Engineering for specific project requirements.

- 1) Project information:
 - a) Description project and proposed street use.
 - b) Justification of the need for use of the street.
 - c) Alternatives that were considered.
 - d) Complete schedule of planned hoarding, including start and end dates, hours of operation and extent of street use at all times.

- 2) Scaled engineering drawing(s) and notes detailing:
 - a) Extent of proposed hoarding area, including length, width and number of lanes, relative to existing curb, back of walk, property line and road markings.
 - b) Proposed temporary traffic to be employed.
 - c) Site fencing, overhead hoarding and access control to protect public safety.
 - d) Removal and/or relocation of any existing traffic control devices, including signage, signals and Park Plus zones (complete with associated numbers).
 - e) Corner visibility (must meet minimum site triangle).
 - f) Location of stockpiling and temporary storage of excavation materials.
 - g) Locations of stockpiling and laydown areas for construction materials.
 - h) Location of storage of supplies and building materials.
 - i) Pedestrian and bicycle accommodation (considering adults, public transit patrons, children and people with special needs).
 - j) Access for emergency vehicles.
 - k) Access to fire hydrants and water valves.
 - l) Construction vehicle access to the site.
 - m) Staging area (where required based on frequency of deliveries).
 - n) Haul routes to minimize impact on adjacent streets (refer to the Truck Route Bylaw 60M90).
 - o) Construction information signage to be posted on the hoarding fence (see template – Appendix G).
 - p) A list of any transit stops, manholes, vaults, signal boxes and any other utilities/services that will be impacted.

- 3) Other items (as required):
 - a) An alternative plan to open the roadway in the event of unexpected circumstances.
 - b) Transit approval.
 - c) Traffic impact study.
 - d) Tree Protection Plan (refer to the Tree Protection Bylaw 23M2002).
 - e) Communication plan.
 - f) _____
 - g) _____
 - h) _____

Appendix C

Record of Temporary Traffic Control (Inspection Form)

Record of Temporary Traffic Control (Inspection Form)

Site location				Work order/Street use permit		
Work order				Contact name		
Phone number				Company		
Inspected by						
Date/ Time	Type of Setup	Setup as per plan (Y/N)	Deficiencies (List)	Photo Taken (Y/N)	Traffic Signal Observation/ Traffic Impact	Action items

RLCA – Right lane closed ahead
 LLCA – Left lane closed ahead
 2RLCA – Right lanes closed ahead
 2LLCA – Left lanes closed ahead
 TWT or 2WT – Two way traffic
 SWC – Sidewalk closed
 HRDING – Hoarding Permit

NPAT – No parking anytime
 NTT – No through traffic
 LTO – Local traffic only
 RC – Road closed
 RCLA BD – Right lane closed ahead both directions
 LLCA BD – Left lane closed ahead both directions

Appendix D – High visibility safety apparel

The following material is reproduced from Z96-15 Standard High-visibility safety apparel, (CSA), February 2016 . While use of this material has been authorized, CSA shall not be responsible for the manner in which the information is presented, nor for any interpretations thereof. All personal protective equipment must meet current CSA standards.

B.1 Basic principles

Users should be familiar with the following principles in the selection of high-visibility apparel:

- a) An assessment of the type and degree of risk should be done for the job site before selecting appropriate high-visibility apparel.
- b) Engineering and administrative controls of traffic and hazards around the workplace should be employed first to reduce risk to pedestrians. High-visibility apparel is considered to be a second line of defence against accidents.
- c) Worksite background significantly affects the conspicuity of garments.
- d) Higher contrast between the background and the workers' apparel provides greater conspicuity.
- e) Environmental conditions (e.g., lightning, rain, fog and snow) significantly affect a garment's conspicuity.
- f) Bright colours are more conspicuous than dull colours under daylight conditions.
- g) Bright colours are less effective than fluorescent colours under low-light conditions.
- h) Large, bright garments are somewhat more conspicuous than small ones.
- i) Full-body coverage provides better conspicuity than partial-body coverage.
- j) Coverage of 360° around the body provides better conspicuity in all viewing directions.
- k) Stripes of colours that contrast with the background material provide even greater conspicuity.
- l) Contrasting stripes provide visual clues to the motion and nature of the object they cover.
- m) Stripes on the arms and legs provide a greater indication of motion and greater conspicuity.
- n) Retro-reflective materials provide high conspicuity under dark conditions (they are preferred over bright colours).
- o) Greater retro-reflectivity provides greater conspicuity under low light conditions.
- p) Contaminated or dirty retroreflective materials provide lower conspicuity.
- q) For optimal performance, garments should be maintained in accordance with the manufacturer's instructions.
- r) For optimal performance, garments should be kept clean (i.e., washed regularly if advised on the garment label).
- s) For safety and best performance, garments should be fitted to the person, taking into consideration the bulk of clothing to be worn underneath the garments.
- t) For safety and best performance, garments should be worn as intended: done up properly around the body with no loose or dangling components.
- u) Garments should be selected and worn in a manner that ensures no other clothing or equipment obscures the high-visibility materials (e.g., glove gauntlets, equipment belts and high-cut boots).
- v) Garments no longer able to provide minimum acceptable levels of conspicuity due to wear and tear, soiling, contamination or age, present a false sense of safety and should be replaced.
- w) Other factors, such as flame resistance, thermal performance, durability, launderability, comfort, flexibility and sizing, should be considered when selecting a garment for the job.

Examples of garment designs

Annex B (Informative)

Note: This Annex is not a mandatory part of this Standard.

Examples of Garment Designs

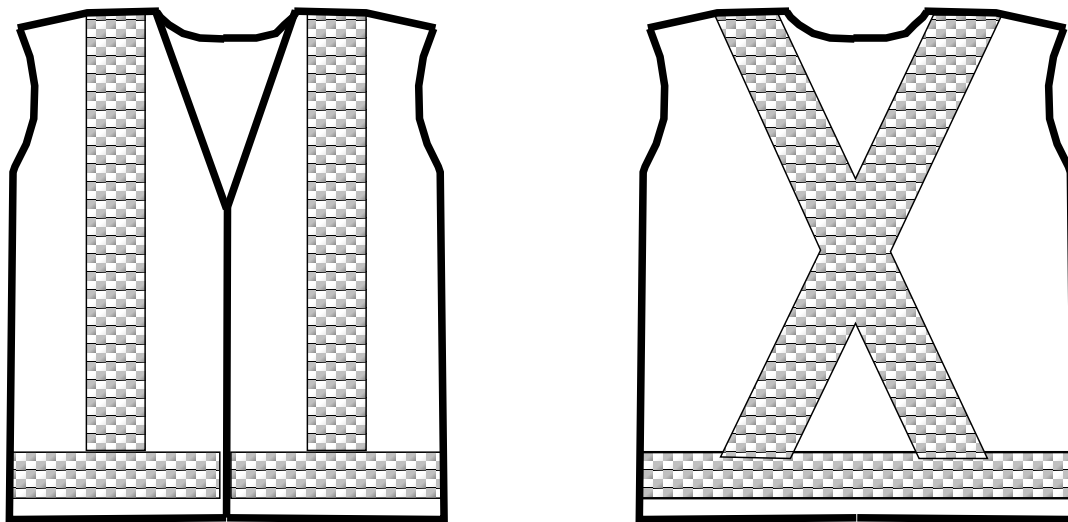
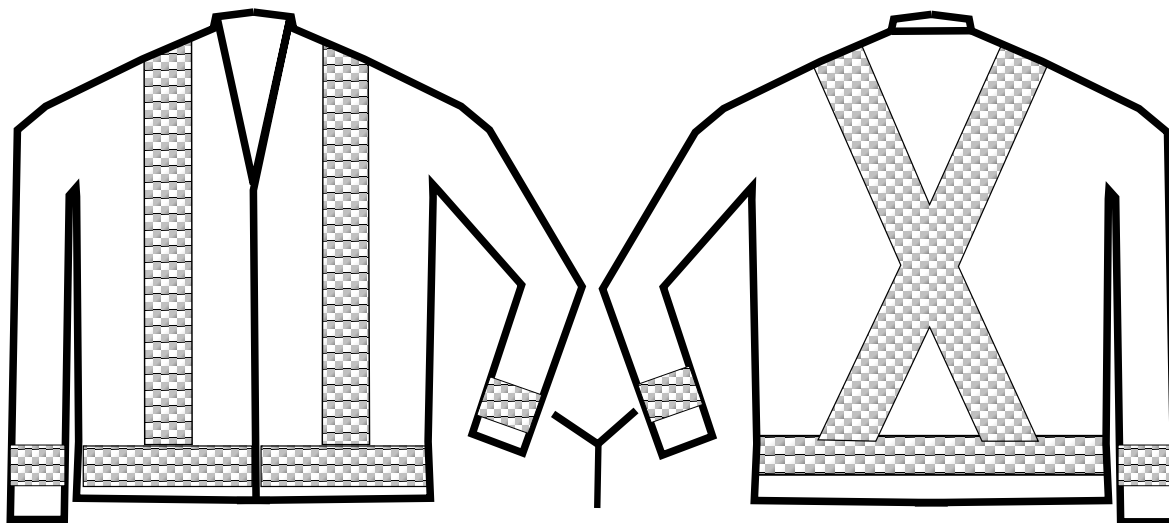

Figure B.2

Class 2 - Vest



(Optional arm bands)

Figure B.3

Class 2 - Jacket

With the permission of Canadian Standards Association, material is reproduced from CSA Standard, Z96-15, Standard High-Visibility Safety Apparel, (CSA) which is copyrighted by Canadian Standards Association, 178 Rexdale Blvd., Toronto, Ontario, M9W 1R3. While use of this material has been authorized, CSA shall not be responsible for the manner in which the information is presented, nor for any interpretations thereof. To contact CSA visit www.csa.ca

Examples of garment designs

Annex B (Informative)

Note: This Annex is not a mandatory part of this Standard.

Examples of Garment Designs

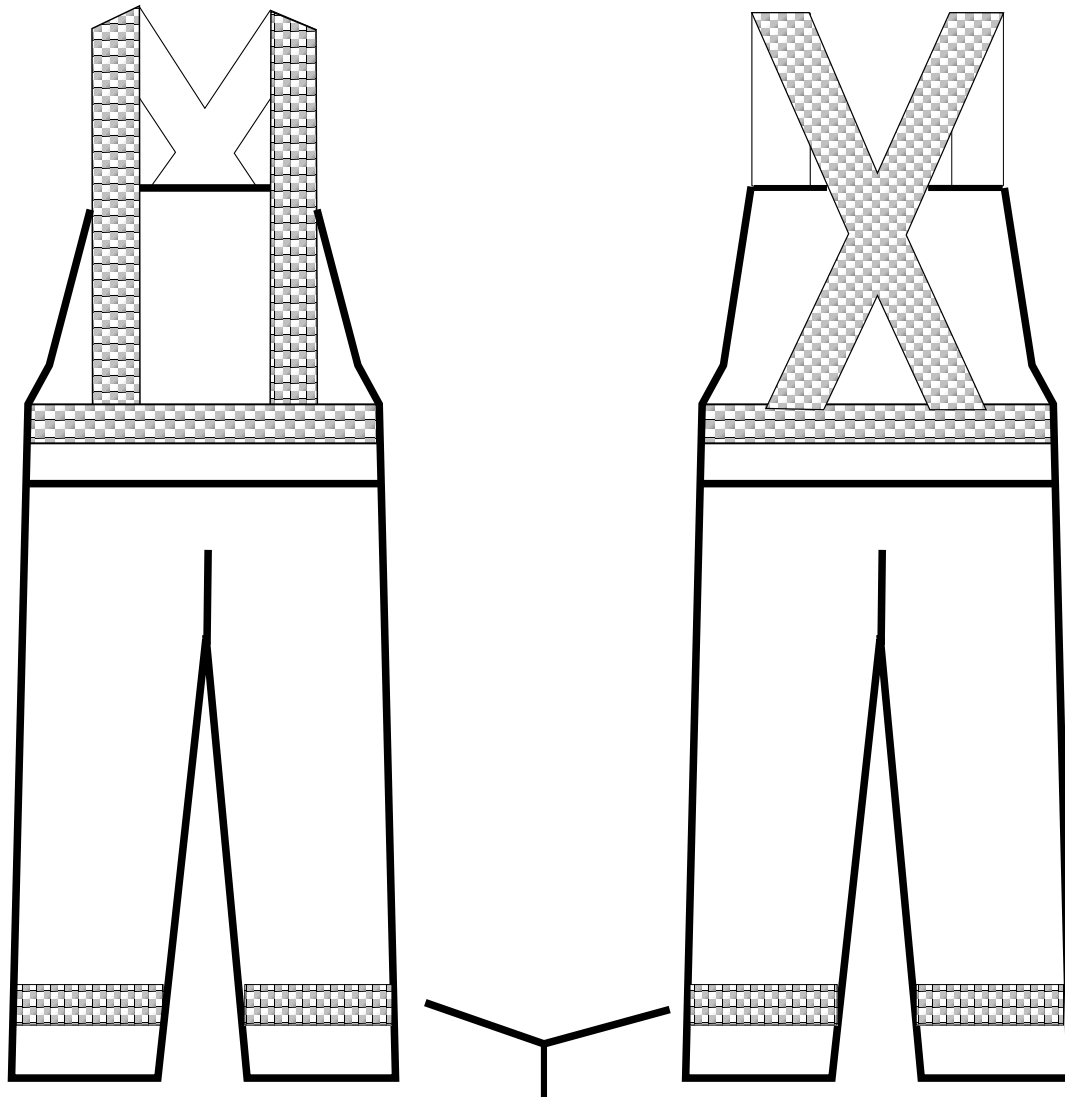

(Optional leg bands)

Figure B.4

Class 2 - Bib Overalls

With the permission of Canadian Standards Association, material is reproduced from CSA Standard, Z96-15, Standard High-Visibility Safety Apparel, (CSA) which is copyrighted by Canadian Standards Association, 178 Rexdale Blvd., Toronto, Ontario, M9W 1R3. While use of this material has been authorized, CSA shall not be responsible for the manner in which the information is presented, nor for any interpretations thereof. To contact CSA visit www.csa.ca

Examples of garment designs

Annex B (Informative)

Note: This Annex is not a mandatory part of this Standard.

Examples of Garment Designs

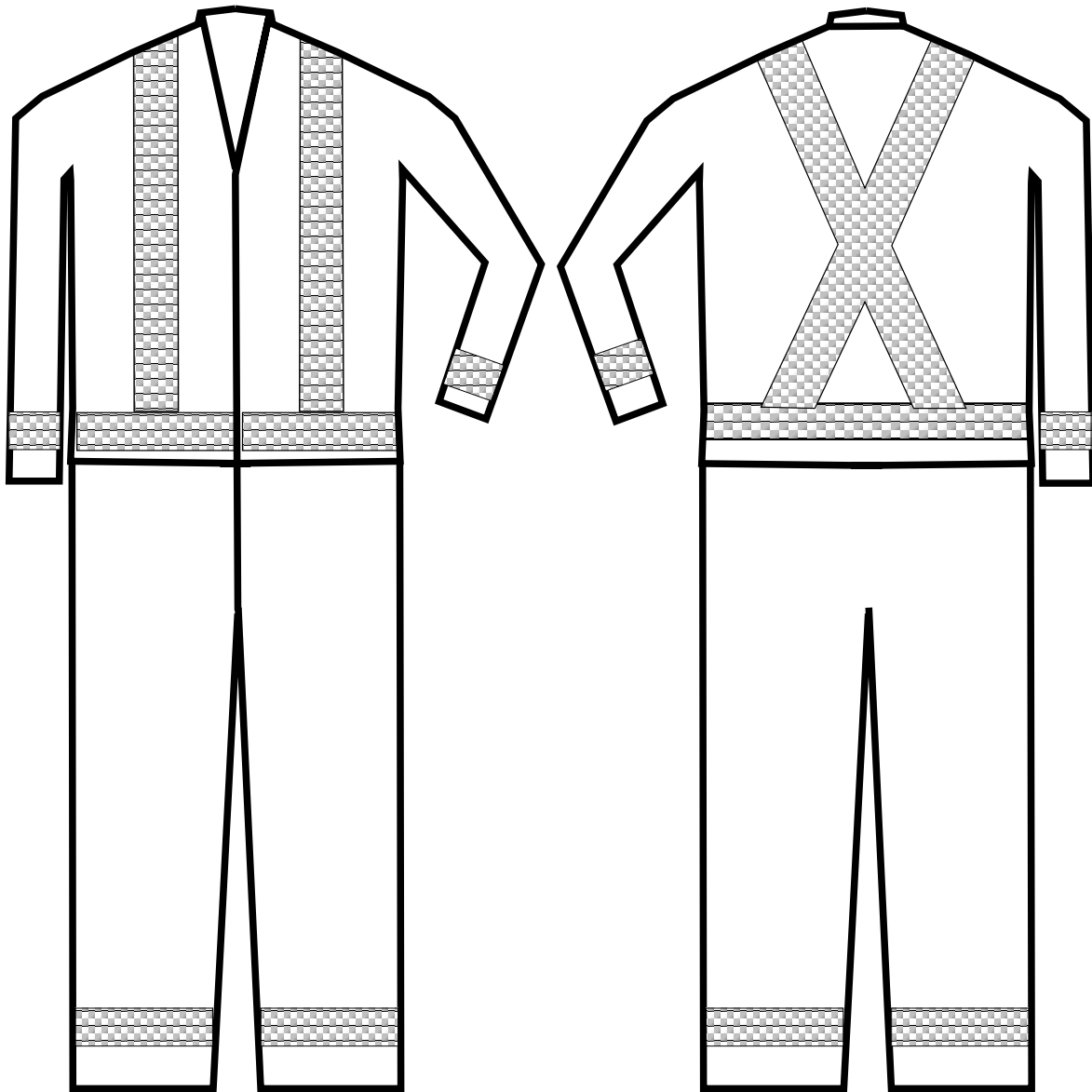









Figure B.5
Class 3 - Coverall

With the permission of Canadian Standards Association, material is reproduced from CSA Standard, Z96-15, Standard High-Visibility Safety Apparel, (CSA) which is copyrighted by Canadian Standards Association, 178 Rexdale Blvd., Toronto, Ontario, M9W 1R3. While use of this material has been authorized, CSA shall not be responsible for the manner in which the information is presented, nor for any interpretations thereof. To contact CSA visit www.csa.ca











Appendix E – Sign sizing guideline

The sign sizes shown in the below table have been provided for reference purposes as the existing roadway environment must be considered. This table provides preliminary guidance for determining potential sign sizes for temporary conditions with three primary sign sizes and custom sized signs reserved for special circumstances:





- Regular – Typically applied for speed limits of 50 km/h or less
- Large – Typically applied for speed limits of 60 km/h or more
- Oversized – May be considered where oversized signs would respect the surrounding roadway environment
- Custom – Special reduced sign sizes in constrained locations

CoC code	TAC code	Sign	Sign size				
			Custom	Regular	Large	Oversized	
11-001	RA-1	Stop		--	60 x 60	75 x 75	90 x 90
11-008	RA-1S4	All Way Stop Tab		--	40 x 25	--	--
11-002	RA-2	Yield		--	60	75	90
11-224 11-225	RB-17	Turn on Red Prohibited		--	60 x 90	--	--
11-240	RB-23	Entry Prohibited		--	60 x 60	75 x 75	90 x 90
11-250 11-251	RB-25	Keep Right/Left		--	45 x 60	60 x 75	--
11-645 11-646	RB-41	Overhead Right/Left Turn Only		--	90 x 90	--	--

CoC code	TAC code	Sign	Image	Sign size			
				Custom	Regular	Large	Oversized
11-789	RB-24	Two-Way Traffic		--	45 x 60	60 x 75	90 x 105
03-003	RB-51	Parking Prohibited		--	30 x 30	--	--
04-003	RB-55	Stopping Prohibited		--	30 x 30	--	--
11-796 11-797	RB	Through Traffic Keep Right/Left		--	75 x 105	90 x 120	--
11-798 11-799	RB	Mandatory Left/Right Lane Turn Left		--	45 x 60	60 x 75	90 x 120
11-800 11-801	RC-4	Stop Line		--	45 x 60	60 x 75	--
11-802 11-803	RC	This Lane		--	45 x 60	60 x 75	--
11-804 11-806	RB-11L RB-11R	Left/Right Turn Prohibited		--	60 x 60	75 x 75	90 x 90
41-0X0	RB-1	Maximum Speed		--	45 x 60	60 x 75	90 x 105
41-252	N/A	Except Bicycle Tab		--	45 x 30	60 x 30	90 x 45



CoC code	TAC code	Sign	Sign size				
			Custom	Regular	Large	Oversized	
41-281 to 41-282	RB	On-Street Bicycle Route		--	30 x 45	45 x 60	--
13-06X	WB-9	Maximum Speed Ahead		--	45 x 60	60 x 75	90 x 105
13-161	WB-1	Stop Ahead		--	75 x 75	90 x 90	120 x 120
13-162	WB-2	Yield Ahead		--	75 x 75	90 x 90	120 x 120
13-422 13-422	WB-36R WB-36L	Right/Left Object Marker		--	30 x 90	60 x 120	--
13-429	WB-36	Double Object Marker		--	45 x 60	--	--
13-460 13-461	WB-16R	Merge		--	60 x 60	75 x 75	90 x 90
13-462 13-463	WA-35	Added Lane		--	60 x 60	75 x 75	90 x 90
13-470	WB-12	"NEW" Starburst		--	75 x 75	--	--
14-307 14-308	RA-4	Pedestrian Crosswalk		--	60 x 75	90 x 120	--

CoC code	TAC code	Sign	Sign size			
			Custom	Regular	Large	Oversized
14-531	IB	Bicycle/Pedestrian Route Marker	--	45 x 75	--	--
16-046 16-047	IF-3A	Exit Gore	--	75 x 120	--	--
19-001 to 19-007	TC-11	Detour Direction Markers	--	60 x 45	75 x 60	--
19-009	TC-10	Detour Ahead	45 x 45	75 x 75	90 x 90	120 x 120
19-010	TC-1	Construction Ahead	60 x 60	75 x 75	90 x 90	120 x 120
19-012	TC-4	Construction Ends	--	75 x 75	90 x 90	120 x 120
19-014	TC	Through Traffic Prohibited	--	60 x 60	75 x 75	--
19-016	TC-2	Road Work	60 x 60	75 x 75	90 x 90	120 x 120
19-020	TC-21	Traffic Control Person Ahead	--	60 x 60	75 x 75	90 x 90
19-021	TC	Be Prepared to Stop	--	75 x 75	--	--

CoC code	TAC code	Sign		Sign size			
				Custom	Regular	Large	Oversized
19-024 19-025	TC-7	Lane Closure Arrow		--	60 x 45	90 x 45	--
19-027 19-028	TC-5	Lane Ends Temporary		--	75 x 75	90 x 90	120 x 120
19-029	TC-34	Road Narrows Temporary		--	75 x 75	--	--
19-031	ID	Speed Fines Double		--	75 x 75	90 x 90	--
19-032 19-033	RB-80S2 RB-80S1	End/Begins Tab		--	75 x 45	90 x 45	--
19-034	TC	Sidewalk Closed		--	60 x 45	--	--
19-036	TC	Yield to Oncoming Traffic		--	75 x 75	--	--
19-037	TC	Crosswalk Closed		--	60 x 45	--	--
19-042 19-043	TC-31	Chevron Alignment Temporary		--	45 x 60	--	--
19-047	TC	Asphalt Curing		--	60 x 60	75 x 75	--

CoC code	TAC code	Sign	Image	Sign size			
				Custom	Regular	Large	Oversized
19-048	TC-47	Grooved Pavement		--	75 x 75	--	--
19-049	TC-49	Pavement Drop-off Temporary		--	75 x 75	90 x 90	120 x 120
19-050 19-051	TC-54	Truck Entrance Temporary		--	75 x 75	90 x 90	120 x 120
19-071 19-072	TC-25	Sharp Turn Temporary		--	60 x 60	75 x 75	90 x 90
19-073 19-074	TC-26	Turn Temporary		--	60 x 60	75 x 75	90 x 90
19-075 19-076	TC-29	Reverse Curve Temporary		--	60 x 60	75 x 75	90 x 90
19-077 19-078	TC-13	Winding Road Temporary		--	75 x 75	90 x 90	120 x 120
19-180	TC-51	Bump Temporary		45 x 45	75 x 75	--	--
19-209	TC	Construction Marker		--	30 x 90	--	--
19-211 to 19-215	TC	Lane Closed Ahead Temporary		--	45 x 60	--	90 x 120

CoC code	TAC code	Sign	Sign size			
			Custom	Regular	Large	Oversized
19-307	TC	Road Closed 	--	90 x 45	--	--
19-308	TC	Local Traffic Only 	--	45 x 60 (3 lines) 90 x 45	--	--
19-400	TC-68	Bicycle Lane Closed 	--	45 x 45	60 x 60	--
19-401	TC	Cyclists Use Detour Ahead 	--	45 x 45	60 x 60	--
19-410 to 19-415	TC-70	Bicycle Lane Detour 	--	45 x 45	60 x 60	--
19-416	TC-71	Bicycle Detour Ends 	--	45 x 45	60 x 60	--
19-786	TC-72	Share the Road Single File Temporary 	--	60 x 60	--	--
19-787	TC-72S	Single File Temporary Tab 	--	60 x 30	--	--
19-788	TC-73	Share the Road Temporary 	--	60 x 60	--	--

CoC code	TAC code	Sign	Sign size					
			Custom	Regular	Large	Oversized		
19-789	TC-73S	Share the Road Temporary Tab			--	60 x 30	--	--
19-800 to 19-855	TC	Pedestrian Detour			--	45 x 45	--	--

Appendix F – Maximum Speed Ahead sign placement

The following chart identifies examples of speed reductions and the suggested minimum distances (m) between the maximum speed ahead sign and the gazetted speed sign. Refer to Chapter 3, Drawing 3.4, Speed Reduction with Right Lane Closure.

Desired speed zone transition km/h		Suggested minimum placement distance in metres for Maximum Speed Ahead signs	
50	40	75	
60	40	100	
70	40	225	
80	40	250	
90	40	275	(1)
60	50	75	
70	50	150	
80	50	250	
90	50	300	(2)
100	50	335	(3)
110	50	370	(4)
70	60	75	
80	60	150	
90	60	200	
100	60	250	
110	60	335	(5)
80	70	100	
90	70	175	
100	70	225	
110	70	300	(6)
90	80	75	
100	80	150	
110	80	200	
100	90	75	
110	90	150	
110	100	100	

- (1) Recommend intermediate transition zone 90 to 60 then 60 to 40.
- (2) Recommend intermediate transition zone 90 to 70 then 70 to 50.
- (3) Recommend intermediate transition zone 100 to 70 then 70 to 50.
- (4) Recommend intermediate transition zone 110 to 80 then 80 to 50.
- (5) Recommend intermediate transition zone 110 to 80 then 80 to 60.
- (6) Recommend intermediate transition zone 110 to 90 then 90 to 70.

Appendix G – Construction site contact info



Building Permit No. _____

CONSTRUCTION SITE CONTACT INFO

IN CASE OF EMERGENCY CALL 911

Site address _____

24-hour site contact for urgent response

Phone: _____

Non-urgent concerns

Contractor: _____

Phone: _____

Email/website: _____

Call 311 to report unsafe conditions to The City of Calgary's Safety Response Unit

Go to calgary.ca/constructionsafety for more information on:

- Public Protection Site Safety Plans
- Advanced Weather Forecasting Systems
- Construction site signage
- Guides for construction sites in Calgary

Printed on recycled material.

