

Traffic Control Device Manual For Work Zones



**TRAFFIC CONTROL DEVICES
MANUAL FOR WORK ZONES**

Section:

FORWARD

Subject:

TABLE OF CONTENTS

1	FORWARD	
	1-1	Table of Contents
	1-2	Record of Amendments
	1-3	Definitions
	1-4	Notice to Manual Users
100	INTRODUCTION	
	101	Purpose and Responsibility
	102	Management of Manual
	103	Shall/Should/May
200	GENERAL	
	201	Requirements of Traffic Control Devices
	202	Need for Guidelines
	203	Application of Guidelines
	204	Principles
300	FUNDAMENTALS OF WORK ZONE TRAFFIC CONTROL	
	301	Work Zone Components
	302	Traffic Control Plans
	303	Traffic Management Plans
	304	Statutes and Regulations
	305	Speeds
400	SIGNS	
	401	Classification of Signs
	402	Signing Categories
	403	Sign Installation
	404	Sign Description
	405	Manufacturing Specifications
500	BARRICADES AND DELINEATORS	
	501	Barricades
	502	Delineators
	503	Barriers
600	MARKINGS	
	601	Pavements Markings
700	FLAGGING	
	701	Flagging
	702	Traffic Observer

Section:

FORWARD

Subject:

TABLE OF CONTENTS

800	LIGHTING DEVICES
801	Lighting Devices
900	ADDITIONAL DEVICES
901	Introduction
902	Electronic Variable Message Boards
903	Portable Rumble Strips
904	Duplication of Signs
905	Lane Width Reduction
906	Law Enforcement
907	Gateway Assemblies
908	Radar Speed Feedback Signs
909	Sign Mounted Warning Flags
1-00	TYPICAL TRAFFIC ACCOMMODATION PLANS - INTRODUCTION
1-01	Introductions
1-02	Definitions
9-00	TYPICAL TRAFFIC ACCOMMODATION PLANS - SHORT DURATION WORK
9-01	Introduction
9-02	Work Adjacent to Roadway
9-03	Work on Shoulder of Roadway
9-04-01	Two Lane Highway - One Lane Closed AADT \leq 1000
9-04-02	Two Lane Highway - Both Lanes Under Repair AADT $<$ 1000
9-05-01	Two Lane Highway - One Lane Closed AADT $>$ 1000
9-05-02	Two Lane Highway - Both Lanes Under Repair AADT $>$ 1000
9-06	Four Lane Highway - One Lane Closed
9-09	Temporary Highway Closure
9-10	Temporary Surface Condition
9-11	Extended Work Areas in Work Zones
10-00	TYPICAL TRAFFIC ACCOMMODATION PLANS - LONG DURATION WORK
10-01	Long Duration Work - Introduction
10-02	Major Construction Projects - Construction Courtesy Signs
10-03-01	Two Lane Highway - Both Lanes Under Construction AADT \leq 200
10-03-02	Two Lane Highway - Both Lanes Under Construction AADT $>$ 200
10-04-01	Two Lane Highway - One Lane Closed - Stationary Operation
10-04-02	Two Lane Highway - One Lane Closed - Moving Operation
10-05-01	Four Lane Highway - One Lane Closed - Stationary Operation
10-05-02	Four Lane Highway - One Lane Closed - Moving Operation
10-06-01	Standard Four To Two Lane Temporary Right Crossover Signing
10-06-02	Standard Four To Two Lane Temporary Left Crossover Signing
10-07	Seal Coat Signing
10-08	Signing of Fresh Oil, Piled, Windrowed or Loosely Spread Material
10-09	Trucks Entering Highway
10-10	Advisory Alternate Route Signs

Section:**FORWARD****Subject:****TABLE OF CONTENTS**

10-11-01	Detour Signing - Two Lane - Local Roadside Detour
10-11-02	Detour Signing - Extensive Detour - Complete Exclusion of Traffic
10-11-03	Road Closed
10-13-01	Pavement Edge Drop-Off - Travelled Way
10-13-02	Pavement Edge Drop-Off - Centreline
11-00	TYPICAL TRAFFIC ACCOMMODATION PLANS - PAVEMENT MARKINGS
11-02	Matrix
11-03-01	Manual Premarking - Manual Premarking, TRPM's, Brightening & Splitting - Two Lane Highway
11-03-02	Manual Premarking - Manual Premarking, TRPM's, Brightening & Splitting - Four Lane Highway
11-04	Premarking at Intersections
11-06	Automated Premarking
11-08-01	Pavement Signs at Intersections - 2 lane
11-08-02	Pavement Signs at Intersections - 4 lane
11-09	Pavement Signs - Stop Bars
11-10-01	Pavement Signs - Railroad Crossing Bars & Crosswalks
11-10-02	Four Lane Highway - One Lanes Closed
11-11-01	Striping Two Lane Highway
11-11-02	Striping Four Lane Highway
11-11-03	Establishment of No Passing Zones with Pilot Vehicles
11-12	Pavement Signs - Bridge Markings
11-13	Pavement Signs - Curbing
11-14-01	Wrap - 2 Lane
11-14-02	Wraps - 4 Lane Highway
11-15	Pavement Signs - Painted Medians
12-00	TYPICAL TRAFFIC ACCOMMODATION PLANS - TESTING SERVICES
12-01	Introduction
12-02	Matrix
12-03	Short Duration - Two Lane Highway - AADT < 1000
12-04	Short Duration - Two Lane Highway - AADT > 1000
12-05	Short Duration Work - Four Lane Highway

Section:**FORWARD****Subject:****TABLE OF CONTENTS**

13-00	TYPICAL TRAFFIC ACCOMMODATION PLANS - ENGINEERING SERVICES
13-02	Matrix
13-03	Surveying - Two Lane Highway - AADT < 1000
13-04	Surveying - Two Lane Highway - AADT >1000
13-05	Surveying - Four Lane Highways
13-06	Surveying - Four Lane Highways Continuous Moving
14-00	TYPICAL TRAFFIC ACCOMMODATION PLANS - PRESERVATION
14-02	Matrix
14-03-01	Thermopatch - Two Lane Highway
14-03-02	Thermopatch - Four Lane Highway
14-04	Gauging Road on AC - Four Lane Highway
14-05	Two Lane Highway - Lane(s) Under Repair
15-00	TYPICAL TRAFFIC ACCOMMODATION PLANS - BRIDGES
15-02	Matrix
15-03-01	Two Lane Highway - One Lane Closed Long Duration
15-03-02	Four Lane Highway - One Lane Closed Long Duration
15-03-03	Two Lane Highway - One Lane Closed Short Duration
15-03-04	Four Lane Highway - One Lane Closed Short Duration
15-03-05	Bridge Closed - Use Detour One Lane With Traffic Lights
16-00	TYPICAL TRAFFIC ACCOMMODATION PLANS - TRAFFIC GUIDANCE
16-01	Introduction
16-02	Matrix
16-03	Ditch
16-04	Shoulder
16-05	Road Surface
16-06	Shoulder
16-07	Road Surface - Four Lane Highway
16-08	Road Surface
18-00	EXAMPLE PROJECT PLANS
18-01	Introduction
18-02	Example - Detailed Long Duration Project Plan

TRAFFIC CONTROL DEVICES
MANUAL FOR WORK ZONES

Section: **FORWARD**

Subject: **DEFINITIONS**

SUMMARY

Words or phrases used in this Manual, are:

"board"

means the Highway Traffic Board (HTB)

"brief duration work"

Foreseen, planned roadwork which require stops of 15 minutes or less that must be carried out near an accompanying work vehicle, in conformity with a typical plan or:

Unforeseen, unplanned roadwork that must be carried out in conjunction with a vehicle equipped with a rotary flashing amber light.

"ministry"

means Saskatchewan Ministry of Highways and Infrastructure.

"Deputy Minister"

means Deputy Minister of Saskatchewan Ministry of Highways and Infrastructure.

"document"

means a section of the Manual (one or more pages) identified by a unique document number (e.g. 301, etc.).

"highways"

means provincial highways and public highways maintained by the ministry.

"long duration work"

includes all construction, maintenance and utility activities requiring a work area for a period of time greater than one day.

"manual"

means "Traffic Control Devices Manual for Work Zones" except when used to specifically describe another manual.

"moving operations"

Road work performed using a vehicle moving up to 20 km/hr for slow moving operations, or greater than 20 km/hr for fast moving operations. The work area will be affected for a short duration of time and will then be returned to its original state. An example of a moving operation is paving.

"provincial highway"

means a public highway, designated as a provincial highway by *The Provincial Highway Designation Regulations*.

"public highway"

means a right-of-way or roadway and includes a bridge, culvert, drain, or other public improvement erected upon or in connection with such public highway.

"short duration work"

includes any daytime maintenance activity, construction project, utility work, preliminary survey work, pavement marking or other miscellaneous highway activity planned for one day or less.

Section:

FORWARD

Subject:

DEFINITIONS

“stationary operation”

Any operation on the roadway where the surface is affected for several hours and the work is completed on a section basis rather than a continuous basis. Example of this type of operation would be base surfacing where windrows are present on the road surface or the laying of the material is occurring.

"traffic observers"

are provided at work areas to warn workers of impending risk from oncoming traffic.

"work area"

means that portion of the roadway where work is being undertaken.

"work site"

includes the transition area which moves traffic out of its normal path, the buffer space which provides protection for motorists and workers, the work area defined above, and the termination area which lets traffic resume its normal path.

"work zone"

means an area of roadway or 10 metres off the edge of pavement where highway construction, maintenance, or utility work activities are taking place.

A work zone is typically marked by signs, channeling devices, barriers, pavement markings, and/or work vehicles. It extends from the first warning sign (WD-A41) or flashing lights on a vehicle to the “End of Work Area” sign (CS-16) or where traffic is no longer being affected.

A work zone may be for short or long durations and may include stationary or moving activities. These include:

Long-term stationary highway construction such as building a new bridge, adding travel lanes to the roadway, and extending an existing roadway.

Mobile highway maintenance such as striping the roadway, median, and roadside grass mowing/landscaping, and pothole repair.

Short-term stationary utility work such as repairing electric, gas, water lines within the roadway.

Most work zones can be divided into five area: Advance Warning Area, Transition Area, Buffer Space, Work Area, and Termination Area.

TRAFFIC CONTROL DEVICES
MANUAL FOR WORK ZONES

Section: **FORWARD**

Subject: **NOTICE TO MANUAL USERS**

NOTICE TO
MANUAL USERS

The material and information in this Manual is intended to provide a guide to accommodate traffic in work zones and providing for its safe passage. Work zone situations may arise which require further or other measures than those described in this Manual to ensure the safe passage of traffic. In each work zone situation, the Manual user should assess the traffic accommodation needs and ensure that all reasonable measures are taken to provide for the safe passage of traffic.

This Manual does not contain a set of absolute rules which must be obeyed without question and without regard to the topography of the work zone, the design of the roadway, the traffic conditions or other factors affecting the work zone. The paramount principle which must be followed always is this: **The maximum level of safety which is practical to achieve in the work zone must be achieved.** Safety must take into account the needs of both motorists and workers in the work zone.

The need for uniform signing of work zones must not be overlooked in the application of the principle of optimizing safety. Non-standard signs or signing methods should not be used to achieve a marginal increase in safety if the changes may lead to motorist confusion in other work zones.

There are a number of measures which apply in every work zone situation, such as the need to erect signs warning of the work zone. However, common sense and a reasonable understanding of motorist needs and reactions are necessary to ensure that the signs are located appropriately. Uniform signing methods aid motorist recognition and appropriate reaction. The guidelines in this Manual shall be followed for the sake of uniformity in the accommodation of traffic in work zones, unless the circumstances of the work zone require that the guidelines be modified to appropriately accommodate traffic.

Compliance with the guidelines in this Manual may not protect the Manual user from third party liability.

Section:**FORWARD****Subject:****NOTICE TO MANUAL USERS****USAGE OUTSIDE
THE MINISTRY**

The Saskatchewan Ministry of Highways and Infrastructure recognizes that this Manual may be used by persons other than those employed by the ministry. The policies, guidelines and practices in this Manual represent recommended practices in common work zone situations on provincial highways. Other road authorities should consider the characteristics of the roadways for which they are responsible and the traffic to be accommodated in developing appropriate policies, guidelines and practices for accommodating traffic.

**OTHER SOURCES
OF INFORMATION**

For further guidance in traffic accommodation, users of this Manual may refer to the *Manual of Uniform Traffic Control Devices for Canada*.

TRAFFIC CONTROL DEVICES MANUAL FOR WORK ZONES

Section:

INTRODUCTION

Subject:

PURPOSE AND RESPONSIBILITY

SUMMARY

The Traffic Control Devices Manual for Work Zones is published and issued by Ministry of Highways and Infrastructure to provide the guidelines for uniform use of devices for traffic control at all work zones on or adjacent to highways.

PURPOSE OF TRAFFIC CONTROL

The fundamental purpose for controlling traffic at work zones is to provide safe passage for motorists through the work zone, as well as safeguarding the workers by separating the traffic from the area of work. All organizations performing work on highways have a responsibility to install and maintain such traffic control devices as are necessary to achieve a reasonable level of safety for all concerned.

THE "MANUAL" IN OTHER EDITIONS

This Manual is a component of the Ministry's "Traffic Control Devices Manual", but is published separately for easy reference.

- Field Manual

The field edition is a reproduction of selected contents of the Manual at a reduced scale. Its purpose is to provide a ready reference for information required in the field.

USAGE OUTSIDE OF THE MINISTRY

Saskatchewan Ministry of Highways and Infrastructure recognizes that others will have access to this Manual. The Manual incorporates many Ministry policies, guidelines and practices which may render it unsuitable for use by others. It is intended as a set of minimum specifications which, if met, would adequately protect the public and the workers on other road systems.

Engineering judgement and common sense must be used in the application of these guidelines. All other users of the Manual are responsible for any traffic control design which the user may produce, as well as all risk of liability associated with any use of this Manual.

Section:**INTRODUCTION****Subject:****PURPOSE AND RESPONSIBILITY****MINISTRY USAGE**

Ministry employees will use the guidelines, principles and typical plan layouts contained in this Manual when planning traffic control measures for typical work zones. The employee must exercise engineering judgement in the application of these guidelines to non-typical work zones.

CONTENT AND SCOPE

The Manual sets forth guidelines for the arrangement of traffic control devices required for the guidance of traffic during road construction, maintenance and other work activities on or adjacent to highways.

The guidelines are suggested for typical situations. A number of typical situations are illustrated showing the appropriate application of standard traffic control devices.

Text and schematic drawings in this Manual are not legal standards except where Statutes or Regulations pursuant thereto are precisely quoted. Criteria for position, location and use of traffic control devices is provided solely for the purpose of guidance and information, and is not a legal standard.

**TRAFFIC CONTROL DEVICES
MANUAL FOR WORK ZONES**

Section:

INTRODUCTION

Subject:

MANAGEMENT OF MANUAL

SUMMARY

This Manual is intended as a guide for Ministry employees, contractors and others engaged in temporary work on or adjacent to highways.

**ASSIGNED MANAGEMENT
RESPONSIBILITY**

Development of the Ministry guidelines pertaining to the physical features and use of traffic control devices is the responsibility of the Design and Traffic Engineering Standards Section, Technical Standards Branch. Accordingly, the Design and Traffic Engineering Services is responsible for managing all aspects of this Manual (e.g. distribution, records, maintaining the associated file, periodic reviews, updating, etc.).

**STANDING
COMMITTEE**

The Ministry will maintain a standing committee whose primary function is to conduct a periodic review of the existing manual documentation.

• **Composition**

The standing committee should be comprised of members representing the various functional groups involved with traffic control in work zones.

• **Appointment**

The members of the committee will be appointed by the Executive Director, Technical Standards Branch.

REVIEW

All sections of this Manual should be reviewed every three years. During the review process, the standing committee should analyze work zone accident records from all available sources to determine if traffic control revisions are necessary to address reoccurring types of accidents.

REVISION

In addition to the revisions resulting from the review process, the standing committee will assess and make recommendations on any requests or suggestions for addition or revision to the contents of the Manual.

Section:

INTRODUCTION

Subject:

MANAGEMENT OF MANUAL

APPROVAL

In accordance with ministry policy, all documentation in this Manual, including Bulletins, will be approved in accordance with ministry policy

The record of approval of individual Manual documents is maintained in the working file.

BULLETIN

Any new or revised information that needs to be circulated to Manual holders on an urgent basis, and time does not permit preparation of the material in final form, should be transmitted as a "BULLETIN".

• Format

Bulletins will be prepared in memorandum form. The following information will be displayed on each Bulletin page transmitted to Manual holders:

1. the word "BULLETIN";
2. Manual document number represented by the Bulletin; and
3. issue date.

• Procedure

The Bulletin will be approved in accordance with ministry policy.

Distribution of Bulletins will be the responsibility of the Design and Traffic Engineering Standards Section, Technical Standards Branch.

Any Bulletin that is distributed will be rewritten in proper Manual form within one year of the date it is issued.

MANUAL MAINTENANCE

Manual holders are responsible for keeping their Manual up to date by:

1. making the necessary entry in the Record of Amendments form in the Manual;
2. placing new or revised documents in the Manual as they are received;
3. placing Bulletins at the beginning of the related chapter; and
4. removing all superseded material and obsolete Bulletins upon receipt of revisions.

TRAFFIC CONTROL DEVICES
MANUAL FOR WORK ZONES

Section:

INTRODUCTION

Subject:

SHALL/SHOULD/MAY

SHALL/SHOULD/MAY

The Traffic Control Devices Manual uses the words "shall" "should", and "may" to describe various traffic operation conditions.

1. SHALL(*) - a mandatory condition. Where certain requirements are described with the "shall" stipulation, it is mandatory that these requirements be met.
2. SHOULD - An advisory condition. Where the word "should" is used, it is considered to be an advisable or recommended procedure, but not mandatory.
3. MAY - a permissive condition. No requirement for design or application is intended.

Please be guided by these definitions. In the event of liability the courts could place an emphasis on these definitions, which also reflect common English usage of the words.

- * The traditional grammatical distinction between SHALL and WILL is fading. They are sometimes used interchangeably to convey the same meaning.

TRAFFIC CONTROL DEVICES
MANUAL FOR WORK ZONES

Section:

GENERAL

Subject:

REQUIREMENTS OF TRAFFIC
CONTROL DEVICES

SUMMARY

This Manual provides the characteristics of effective traffic control devices. These characteristics must be considered in the design of traffic control devices and the use of the devices in work zones.

While this Manual provides guidelines for design and application of traffic control devices, it is not a substitute for good judgement. Placement, maintenance and uniformity shall be considered in each situation to ensure effectiveness.

CHARACTERISTICS OF
EFFECTIVE TRAFFIC
CONTROL DEVICES

Effective traffic control devices:

1. fulfill a need;
2. command attention;
3. convey a clear, simple meaning;
4. command respect of road users; and
5. give adequate time for proper response.

CONSIDERATIONS

The following shall be taken into consideration in designing and utilizing traffic control devices effectively:

• Design

The design of the device should:

1. ensure such features as size, contrast, colours, shape, composition and lighting or reflectorization are combined to draw attention to the device;
2. produce a clear meaning when shape, size, colours and simplicity of message are combined; and
3. ensure that legibility and size combine with placement to permit adequate time for the motorist to recognize and respond to the device and that uniformity, size and legibility combine to command respect.

Section:

GENERAL

Subject:

REQUIREMENTS OF TRAFFIC
CONTROL DEVICES

If modification of a device is necessary to achieve optimum safety in a particular application of a device, the modifications shall be the minimum necessary to achieve optimum safety and have regard to the characteristics of effective traffic control devices and the design and uniformity considerations in this Manual.

- Placement

Devices should be placed:

1. within the cone of vision of the viewer so that it will command attention;
2. to convey the proper meaning; and
3. where motorists travelling at normal speed have adequate time to make a proper response.

- Operation or Application

Appropriate devices and related equipment must be used to meet the specific traffic requirements at a given location.

To the extent possible, the device must be placed and operated in a uniform and consistent manner to assure that motorists can be expected to respond properly to the device, based on their previous exposure to similar traffic control situations.

The use of standard flags or flashing amber lights in conjunction with signs is permitted, provided these devices do not interfere with the motorists' view of the sign face.

- Maintenance

Devices must be maintained to ensure that they are legible and visible. Clean, legible, properly installed devices in good working condition command the respect of motorists.

In addition to physical maintenance, functional maintenance is required to adjust traffic control devices to current conditions and to remove or cover unnecessary traffic control devices.

- Uniformity

Uniform traffic control devices simplify the task of the motorists by aiding in recognition, understanding and interpretation. In economic terms, uniformity reduces costs associated with manufacture, installation, maintenance and administration.

Simply stated, uniformity means treating similar situations in the same way, regardless of who performs the work or the area of the province in which it is located.

**TRAFFIC CONTROL DEVICES
MANUAL FOR WORK ZONES**

Section:

GENERAL

Subject:

NEED FOR GUIDELINES

SUMMARY

This Manual gives written and schematic guidelines for traffic control. These guidelines are flexible. The guidelines should be followed to the extent that it is possible to do so, for the sake of consistency and uniformity and modified to the extent necessary to achieve optimum traffic control and safety in a particular situation.

**GUIDELINE
APPLICATION**

Traffic control is necessary to route traffic through and around highway work activities. Due to the variety of work activities and topographical features encountered in work zones, no one sequence of traffic control devices is universally applicable. The guidelines in this Manual may be used to achieve appropriate traffic control in the situations described in this Manual and must be adapted to achieve appropriate traffic control to suit the particular circumstances of other situations.

LAW PREVAILS

Traffic control must not contravene the law.

TRAFFIC CONTROL DEVICES MANUAL FOR WORK ZONES

Section:

GENERAL

Subject:

APPLICATION OF GUIDELINES

SUMMARY

It is not practical to prescribe detailed standards of application for all situations that may conceivably arise. Consequently, guidelines are presented for the most common situations. It is emphasized that these are guidelines for typical situations and that additional or other protection must be provided when unusual complexities and hazards prevail.

EXTENT OF PROTECTION

The speed and volume of traffic, sight distance, visual clutter, duration of operation and exposure to hazards are among the considerations which must be taken into account in providing protection for a particular work zone. In all situations the particular circumstances of the work zone must be considered together with the guidelines in this Manual, to achieve traffic accommodation which provides optimum safety for motorists and workers.

APPLICATION OF THE GUIDELINES

Guidelines for the use of traffic control devices are illustrated for typical and common situations. Physical features or other factors may require additional protection when unusual complexities and hazards occur. In these instances, common sense and engineering judgement must be used, together with the guidelines in this Manual, to select and place the most appropriate devices.

UNIFORMITY OF APPLICATION

Uniformity of application of traffic control devices is equally as important as standardization of design and placement of devices. Motorists' recognition and understanding is facilitated by marking similar conditions consistently. The application and use of traffic control devices must take into account the particular features of a work zone which differ from the typical situations illustrated in the typical plans in this Manual. To the extent that it is necessary to draw a motorists' attention to these particular features, it must be done in a manner as consistent with these guidelines as the circumstances permit.

CONTRACTS

This Manual must be referenced in all contracts for construction or maintenance activities which require traffic accommodation.

MANAGEMENT RESPONSIBILITY AND TRAINING

Responsibility for traffic accommodation must be clearly assigned within an organization and personnel must be appropriately trained to ensure that engineering judgement and common sense are used, together with knowledge of the guidelines in this Manual.

TRAFFIC CONTROL DEVICES MANUAL FOR WORK ZONES

Section:

GENERAL

Subject:

PRINCIPLES

SUMMARY

This Manual provides guidelines for the design, installation and maintenance of traffic control devices. These guidelines are directed to the safe and expeditious movement of traffic through work zones and to the safety of individuals performing the work.

PRINCIPLES AND RELATED PROCEDURES

Work zones may present the motorist with unexpected or unusual situations. Consequently, special care must be taken in applying traffic control techniques in these areas.

Consideration of the following principles and procedures will contribute to the safety of motorists and workers in work zones:

- Traffic Safety

Traffic safety in work zones is an integral element of every project from planning through to final completion of the work. It must be given a high priority. Safety of the motorist and workers must be kept in mind at all times.

Careful design and application of traffic accommodation plans are vital elements in the achievement of traffic and worker safety.

- Traffic Movement

The objective should be to route traffic through zones with geometric and traffic control devices as nearly as possible to those encountered for normal highway situations.

Work zones should not confuse the motorist. Hence, abrupt changes should be avoided. Well delineated transitions should be provided, whenever possible, especially where lanes are closed, roadway widths are reduced and where detours are required. Traffic movement through the work zone should be inhibited as little as possible.

- Guidance for Motorists

Motorists should be guided in a clear and positive manner while approaching and traversing work zones.

Adequate warning, delineation and channelization by use of appropriate traffic control devices for varying conditions of light and weather will be provided to assure the motorist of positive guidance in advance of and through the work zone.

For long duration work areas, inappropriate pavement markings should be removed to eliminate any misleading cues to drivers. On short duration projects, existing markings may be left in place if the intended vehicle paths can be appropriately delineated using other traffic control devices.

Section:

GENERAL

Subject:

PRINCIPLES

Flagging procedures, when used, can provide positive guidance to the motorist when travelling through the work zone.

- Operation

It is important to ensure that all elements of the traffic accommodation plan are implemented in a manner which is consistent and effective in providing safe conditions for motorists and workers. Work zones should be regularly monitored under varying conditions of traffic volumes, light, and weather to ensure that traffic control measures are operating effectively and that all devices used are clearly visible, clean and in good repair.

The circumstances of each accident in a work zone should be examined to determine the adequacy of traffic accommodation measures. Measures to correct any deficiencies must be implemented as soon as it is practical. In addition, accident records should be maintained and analyzed periodically to guide officials in improving the work zone operation. Modification in traffic controls or working procedures may be required in order to expedite safe traffic movement and promote worker safety.

When the work zone is inactive, including nights, weekends and holidays, signs not required for traffic accommodation will be removed or covered. All traffic control devices will be removed or covered immediately after they are no longer applicable.

- Roadside Safety

The maintenance of roadside safety requires constant attention.

To accommodate run-off-the-road incidents, disabled vehicles or other emergency situations, it is desirable to provide an unencumbered roadside recovery area that is as wide as practical.

Traffic is channelized by the use of pavement markings, signing, flexible posts and other lightweight devices which yield when hit by errant vehicles. In addition, barriers may be used to provide protection to workers, particularly in longer term or labour intensive activities such as bridge deck repairs. Barriers should be placed to minimize the risk of right angle impact or other risk to motorists.

Equipment, materials and debris should be stored in such a manner as not to be vulnerable to run-off-the-road vehicle impact.

TRAFFIC CONTROL DEVICES MANUAL FOR WORK ZONES

Section: FUNDAMENTALS OF WORK ZONE
TRAFFIC CONTROL

Subject: ADVANCE SIGNING AND
WORK ZONE COMPONENTS

SUMMARY

Traffic controls and the work activity must be coordinated to provide safe and expeditious movement of traffic along with efficient work progress.

Traffic controls in work zones warn motorists of potential hazards, separate motorists from the work force and delineate a path for traffic to follow.

Work zone traffic control devices are usually not used singularly but are deployed as a system of devices. The correct deployment of the devices is an important element in achieving safe performance of highway work.

This document outlines the general principles for preparation of traffic accommodation plans which describe how the system of devices is employed. Examples of typical traffic accommodation plans for common situations are included in this Manual.

ADVANCE SIGNING ZONE

The advance signing is the section of roadway two to three kilometres prior to the work zone in both directions. The advance signing can be divided into 2 sections which are described below and illustrated on the last page of section 301.

- Project Information Area

The project information area is used to provide the driver with specific details of the project. This area is two to three kilometres from the project limit and may include signs that define what type of construction is occurring, the cost of the project and total length of the project these signs would be installed by the Ministry.

- Speed Transition Area

The speed transition area is used to inform drivers that they need to start reducing their speeds. The transition area allows drivers to slow down at a more reasonable rate.

WORK ZONE

An work zone is an area of a roadway or 10 metres off the edge of pavement where highway construction, maintenance, or utility-work activities are taking place.

A work zone is typically marked by signs, channeling devices, barriers, pavement markings, and/or work vehicles. It extends from the first warning sign (WD-A41) or flashing lights on a vehicle to the “End of Work Area” sign (CS-16) or where traffic is no longer being affected.

Section:
FUNDAMENTALS OF WORK ZONE
TRAFFIC CONTROL

Subject:
ADVANCE SIGNING AND
WORK ZONE COMPONENTS

A work zone may be for short or long durations and may include stationary or moving activities. These include:

- Long-term stationary highway construction such as building a new bridge, adding travel lanes to the roadway, and extending an existing roadway.
- Mobile highway maintenance such as striping the roadway, median, and roadside grass mowing/landscaping, and pothole repair.
- Short-term stationary utility work such as repairing electric, gas, or water lines within the roadway.

Most work zones can be divided into five areas: Advance Warning Area, Transition Area, Buffer Space, Work Area, and Termination Area.

- Advance Signing Area

The advance warning area is used to inform drivers to expect roadwork ahead. Motorists require sufficient distance to adjust to the altered situation before reaching it. The warning area may vary from a single sign or flashing lights to a series of signs in advance of the work area.

- Transition Area

When work is being performed on one or more of the lanes, lane closure is required. In the transition area, traffic is channeled from the normal alignment to the path required to move traffic past the work area.

It is imperative that no work material, vehicles or equipment be stored or parked in the transition area.

The transition area should be delineated by channelizing devices, unless otherwise indicated in the typical layout.

The length and condition of the taper for the specific situation is extremely important. An inadequate taper will likely produce undesirable traffic movements and increase the possibility of accidents.

The transition area must be obvious to motorists. The intended path must be clearly delineated so that drivers will not mistakenly follow the wrong path. For long duration operations, there may be a requirement to remove existing pavement markings and possibly to enhance the transition area with temporary pavement markings to identify a clear route where there could be confusion regarding the proper path.

Section:
**FUNDAMENTALS OF WORK ZONE
 TRAFFIC CONTROL**

Subject:
**ADVANCE SIGNING AND
 WORK ZONE COMPONENTS**

With moving operations, the transition area moves with the work area. A vehicle with a flashing arrow sign may be used to warn and guide traffic into the proper lane.

- Buffer Space

The buffer space is the open and unoccupied area between the transition and work areas. This space provides a margin of safety for both motorists and workers. It will be free of equipment, workers, materials, and parked vehicles.

- Work Area

The work area is that portion of the roadway where the work is being undertaken. Work areas may be in a fixed location or may move as work progresses. The work area is set aside for workers, equipments and material storage.

Channelizing devices may delineate the work area. As an additional safety feature, barriers may shield the work area in a confined location. Every practical effort will be made to minimize hazards to motorists and workers.

- Termination Area

The termination area provides the necessary distance for the traffic to clear the work area and return to the normal traffic lanes.

A downstream taper may be used at the end of the work zone to show motorists that they can move back into the lane that was closed. The taper is placed in the termination area to smooth the traffic flow.

- Removing/covering signs or devices

The WD-A41 (Roadwork Ahead) sign and the WD-A41T (Workers Present) tab shall be removed or covered when workers are no longer present in the work zone.

The CS-46C (Maximum 60 Fines Triple) sign shall be removed or covered when workers are no longer present. In situations where a hazard remains on the road surface when the workers or equipment are no longer present, the 60 km/hr sign may remain. The “Fines Triple” portion of the sign shall be covered.

All traffic control devices shall be removed or covered immediately after they are no longer applicable.

Section: FUNDAMENTALS OF WORK ZONE TRAFFIC CONTROL

Subject: ADVANCE SIGNING AND WORK ZONE COMPONENTS

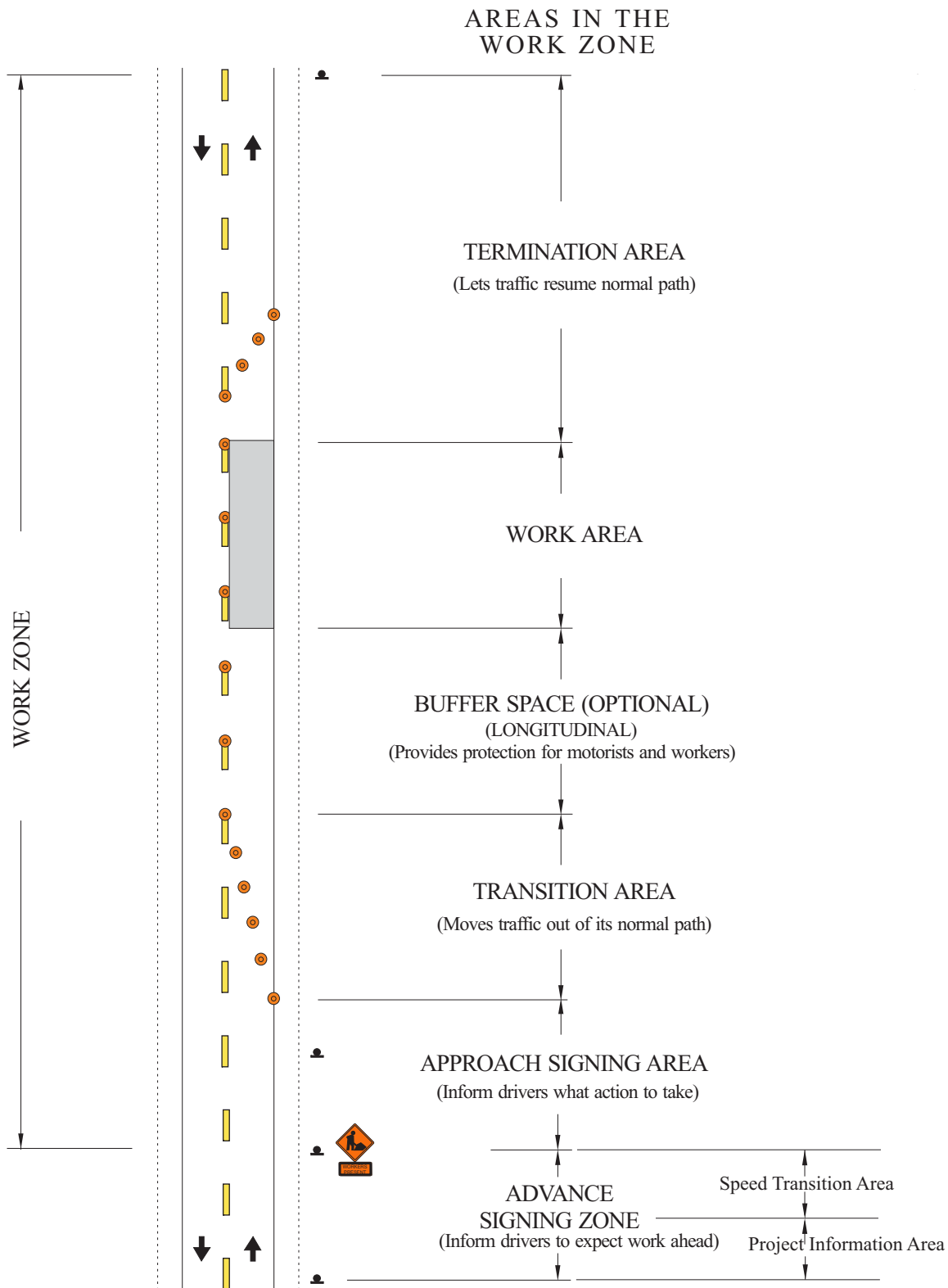

TRAFFIC CONTROL DEVICES MANUAL FOR WORK ZONES

Section:
FUNDAMENTALS OF WORK ZONE
TRAFFIC CONTROL

Subject:
TRAFFIC ACCOMMODATION PLANS

SUMMARY

A Traffic Accommodation Plan, in detail appropriate to the complexity of the work, will be available and put into operation before the site is occupied. Typical Traffic Accommodation Plans are to be adopted to adequately address issues specific to individual projects. All Traffic Accommodation Plans must be kept on site and available upon request.

RANGE AND DETAIL OF TRAFFIC ACCOMMODATION PLANS

Traffic Accommodation Plans may range in scope from a reference to a typical Traffic Accommodation Plan in this Manual to a very detailed Traffic Accommodation Plan designed solely for a specific project. The needed detail in the plan depends on the complexity of the work and on the conflicts between traffic and the work.

The Traffic Accommodation Plan includes, but is not limited to, such items as signing, application and removal of pavement markings, placement of devices for delineation, channelization and detours.

TYPICAL TRAFFIC ACCOMMODATION PLANS

Each project needs to be assessed to determine the adequacy of the typical Traffic Accommodation Plan in achieving worker safety and the required level of traffic control. The Manual contains typical Traffic Accommodation Plans which portray typical applications of traffic control devices for a variety of work zone activities and situations. For a normal and repetitive type situation, for which the typical plan adequately fulfils the need, no separate plan needs to be developed.

TRAFFIC ACCOMMODATION PLANS FOR SPECIFIC PROJECTS

A detailed Traffic Accommodation Plan will be prepared for projects where the typical Traffic Accommodation Plan is determined to be inadequate to achieve the required level of traffic control and worker safety.

TRAFFIC ACCOMMODATION PLANS

- Project Examples

An example of a situation where a detailed Traffic Accommodation Plan may be required is where several workers are confined to a restricted work area such as a bridge deck repair project. Another example of where a detailed plan may be required is on projects with high traffic volumes in close proximity to a larger city.

TRAFFIC CONTROL DEVICES MANUAL FOR WORK ZONES

Section:
**FUNDAMENTALS OF WORK ZONE
TRAFFIC CONTROL**

Subject:
TRAFFIC MANAGEMENT PLANS

SUMMARY

A Traffic Management Plan (TMP), in detail appropriate to the complexity of work will be prepared by the contractor and completed prior to occupying the construction site.

BACKGROUND

A TMP is a set of coordinated traffic management strategies that describes how a contractor will manage work zone impacts of a highway construction project. Traffic management strategies are comprised of an operational plan, communication plan and incident management strategies. The need for a TMP is determined in the design phase of construction. They will be produced whenever there is increased exposure to motorists and workers as a result of a larger percentage of truck traffic, where traffic delays are significant, there are environmental impacts etc.

Guidance on the information required in the TMP will be provided in the Special Provisions section of the contract.

OPERATIONAL PLAN

An operational plan includes strategies used to mitigate work zone impacts through the use of improved traffic operations and management techniques.

An operational plan may include travel demand management strategies, ITS strategies, including signals, safety strategies, enforcement strategies, etc.

COMMUNICATION PLAN

A communication plan provides processes to inform the travelling public, stakeholders and MHI of traffic operations and planned and unplanned changes to traffic operations. A communication plan is intended to be adjusted as required throughout the project as issues arise.

A communication plan will:

- Define a process to routinely notify MHI of scheduled work;
- Define a process to notify the travelling public of unscheduled traffic delays;
- Ensure the local Rural Municipality, local businesses and affected residents are made aware of the schedule including expected road closures, extended delays and detour routes in advance of the commencement of work.

Section: FUNDAMENTALS OF WORK ZONE
TRAFFIC CONTROL

Subject: TRAFFIC MANAGEMENT PLANS

INCIDENT MANAGEMENT PLANS

It identifies the processes and procedures for detecting and responding to unplanned events or incidents. The intent is to ensure the safety of motorists and workers while minimizing the effects on traffic flow and construction works.

An incident response plan will:

- Identify the type of traffic incidents that could occur in the work zone
- Identify the Traffic Accommodation Supervisor
- Contain a contact list of emergency response agencies
- Identify procedures to respond to a traffic incident that occurs within a work zone including:
 - Emergency detour routes
 - Procedure to allow emergency vehicles access to site
- Identify a procedure to inform MHI of the following:
 - Incident occurrence
 - Response measures taken
 - Clearance measures taken
- Identify the procedure to restore traffic flow around an incident site as quickly as possible.

TRAFFIC CONTROL DEVICES
MANUAL FOR WORK ZONES

Section:
FUNDAMENTALS OF WORK ZONE
TRAFFIC CONTROL

Subject:
STATUTES AND REGULATIONS

SUMMARY

Regulations made pursuant to the Statutes of Saskatchewan will pertain to work zone locations as they would to any other provincial highway locations. Some legislation and regulatory provisions, as amended from time to time, can apply specifically to work zone activity. Several of these provisions, as well as provisions related to "Speeds" generally, are included here for ready reference.

Information with respect to Minister's Orders, pursuant to any of the following Legislation, is outlined in the Ministry's *Financial Administration Manual* and the *Non-Financial Signing Authority Delegation Document*.

THE HIGHWAYS AND
TRANSPORTATION ACT
1997

• Section 20 - Speed Zones

Section 20(1) The Minister may establish speed zones on any provincial highway and on any authorized detour from a provincial highway for any class or classes of vehicles by erecting official signs indicating the maximum speed applying to each class of vehicle in the speed zone.

(2) The Minister may establish no-parking zones by erecting official signs stating that parking is prohibited or limited within that no parking zone.

(3) Where the Minister has established a no-parking zone, no person shall park within that no-parking zone, including on that portion of the roadway situated to the right of the solid white line and commonly referred to as "the shoulder".

(4) No person shall fail to comply with the prohibition or limitation indicated on an official sign erected pursuant to subsection (1) or (2).

(5) Every person who contravenes subsection (4) is guilty of an offence and liable on summary conviction to a fine as set forth in Category B in Schedule A.

Section: FUNDAMENTALS OF WORK ZONE
TRAFFIC CONTROL

Subject: STATUTES AND REGULATIONS

- Section 20.1 - Speed Limits

20.1(1) The Minister may fix the maximum speed on a provincial highway or a portion of a provincial highway.

(2) If the Minister fixes a maximum speed on a provincial highway or portion of a provincial highway pursuant to subsection (1), the minister shall cause to be erected and maintained, at those locations along the provincial highway or the portion of the provincial highway that the minister considers appropriate, signs indicating the maximum speed.

- Section 27 -
Erection of Speed Signs

Official signs may be erected, maintained and removed by:

(a) employees of the Ministry;
 (b) persons under contract with the Ministry to do work on a public highway; or
 (c) any person authorized by the Minister to work in the right of way of a public highway.

THE TRAFFIC SAFETY ACT

- Sections 199, 201, 203 - Speed

199(1) Subject to the other provisions of this Act, no person shall drive a vehicle on a highway:

(a) at a speed greater than 80 km/hr; or

(b) at a speed greater than the maximum speed indicated by any signs that are erected on the highway in accordance with section 200 or 201 or that are placed at the entrance to a park in accordance with section 202.

(2) Notwithstanding any provisions of this Act, a person who drives a vehicle at a speed greater than 50 km/hr over the applicable speed limit mentioned in subsection (1) is guilty of an offence.

(3) No person shall drive a vehicle on a highway at a speed greater than is reasonable and safe in the circumstances.

(4) No person shall drive a vehicle on a highway at a speed that impedes the normal and reasonable movement of traffic on the highway except when necessary for safe operation of the vehicle.

Section:
**FUNDAMENTALS OF WORK ZONE
 TRAFFIC CONTROL**

Subject:
STATUTES AND REGULATIONS

201 If pursuant to *The Highways and Transportation Act, 1997* or any former *Highways and Transportation Act*, a speed zone is established by the erection of an official sign, no person shall drive a vehicle on the portion of the highway within the speed zone at a greater speed than that indicated.

203(1) No person shall drive a vehicle on a highway at a speed greater than 60 km/hr when passing:

- (a) a highway worker or flagperson; or
- (b) any highway equipment occupied by a highway worker, whose presence on the highway is marked in the manner determined in the regulations made by the board.
- (c) any highway equipment on a highway that has its Ministry issued warning lights in operation, whether it is in motion or not.

(2) A flagperson or peace officer may direct traffic by voice, hands, signs or other signals while controlling traffic.

(3) Every person driving a vehicle shall obey the directions given pursuant to subsection (2).

THE HIGHWAY WORKER IDENTIFICATION REGULATIONS

- Section 1 and 2 -
 Marking Presence of
 Highway Workers

(1) These regulations may be cited as *The Highway Worker Identification Regulations*.

(2) For the purposes of subsection 37(1) of *The Highway Traffic Act*.

(a) The presence of highway workers on a highway is to be marked by the erection of a sign that:

- i) displays a black symbol of a highway worker on an orange background;
- ii) is placed not more than three kilometres in advance of the actual location of the highway workers;
- iii) is a minimum size of 60 cm by 60 cm; and
- iv) is reflective or illuminated at night.

(b) The presence of flagpersons on a highway is to be marked in accordance with clause (a) and, in addition:

- i) flagpersons shall wear a brightly coloured vest, shirt or jacket that is not covered by any other clothing or article;

Section: FUNDAMENTALS OF WORK ZONE
TRAFFIC CONTROL

Subject: STATUTES AND REGULATIONS

of 450 mm by 450 mm and displays the word "STOP" on one side and the word "SLOW" on the other side; and

iii) vests, shirts or jackets worn as required by subclause (i) and paddles used as required by subclause (ii) are to be reflectorized at night.

SIGNS REQUIRED

To legitimize 203(1) of *The Traffic Safety Act*, and *The Highway Worker Identifications Regulations* as discussed above, Only the Roadwork Ahead sign (WD-A41) shown below is required at the beginning of the work zone and repeated every three kilometres if needed.



WD-A41

THE OCCUPATIONAL HEALTH AND SAFETY REGULATIONS

• Section 132 - Designated Signallers

132(1) Where the giving of signals by a designated signaller is required by these regulations, an employer or contractor shall:

- (a) designate a worker to be the designated signaller;
- (b) ensure that the designated signaller is sufficiently trained to carry out the signallers' duties in a manner that will ensure the signaller's safety and the safety of other workers; and
- (c) keep a record of the training required by clause (b) and give a copy of the record to the designated signaller.

(2) An employer or contractor shall:

- (a) provide each designated signaller with, and require the signaller to use, a high visibility vest, armbands or other high visibility clothing, whether the signaller is on a public highway or is at any other place of employment; and

Section:
**FUNDAMENTALS OF WORK ZONE
 TRAFFIC CONTROL**

Subject:
STATUTES AND REGULATIONS

- (b) provide each designated signaller with a suitable light to signal with during hours of darkness and in conditions of poor visibility.
 - (3) An employer or contractor shall:
 - (a) install suitably placed signs to warn traffic of the presence of a designated signaler before the signaler begins work; and
 - (b) where reasonably practicable, install suitable overhead lights to illuminate a designated signaler effectively.
 - (4) A designated signaler shall ensure that it is safe to proceed with a movement before signaling for that movement to proceed.
 - (5) Where the giving of signals by a designated signaler is required by these regulations, an employer or contractor shall ensure that:
 - (a) no worker other than the designated signaler gives signals to an operator except in an emergency; and
 - (b) only one designated signaler gives signals to an operator at a time.
 - (6) Where hand signals cannot be transmitted properly between a designated signaller and an operator, an employer or contractor shall ensure that additional designated signallers are available to effect proper transmission of signals or that some other means of communication is provided.
 - (7) Where two or more designated signallers are used, an employer or contractor shall ensure that the designated signallers are able to communicate effectively with each other.
- Section 133 - Risk From Vehicular Traffic
- 133(1) An employer or contractor shall ensure that a worker who is at risk from vehicular traffic, whether on a public highway or at any other place of employment, is provided with and required to use a high visibility vest, armllets or other high visibility clothing.
 - (2) Where there is a danger to a worker from vehicular traffic on a public highway, an employer or contractor shall develop and implement a traffic control plan, in writing, to protect the worker from traffic hazards by the use of one or more of the following:

Section:
FUNDAMENTALS OF WORK ZONE
TRAFFIC CONTROL

Subject:
STATUTES AND REGULATIONS

- (a) warning signs;
 - (b) barriers;
 - (c) lane control devices;
 - (d) flashing lights;
 - (e) flares;
 - (f) conspicuously identified pilot vehicles;
 - (g) automatic or remote controlled traffic control systems;
 - (h) designated signallers directing traffic.
- (3) An employer or contractor shall ensure that:
- (a) workers are trained in the traffic control device plan developed pursuant to subsection (2); and
 - (b) the traffic control plan developed pursuant to subsection (2) is made readily available for reference by workers at the place of employment.
- (4) An employer or contractor shall use designated signallers to control traffic on a public highway only where other methods of traffic control are not adequate or suitable.
- (5) Where designated signallers are used to control traffic on a public highway, an employer or contractor shall provide:
- (a) at least one designated signaller if:
 - (i) traffic approaches from one direction only; or
 - (ii) traffic approaches from both directions and the designated signaller and the operator of an approaching vehicle would be clearly visible to one another; and
 - (b) at least two designated signallers if traffic approaches from both directions and the designated signaller and the operator of an approaching vehicle would not be clearly visible to one another.

Section: FUNDAMENTALS OF WORK ZONE
TRAFFIC CONTROL

Subject: STATUTES AND REGULATIONS

- (6) Where there is or may be a hazard to a worker from traffic at a place of employment other than a public highway, an employer or contractor shall develop and implement a traffic control plan to protect the worker from traffic hazards.
- (7) A traffic control plan required by subsection (6) must:
- (a) be in writing;
 - (b) be made readily available for reference by workers at the place of employment; and
 - (c) set out, where appropriate,
 - i) the maximum allowable speed of any vehicle or class of vehicles, including powered mobile equipment, in use at the place of employment;
 - ii) the maximum operating grades;
 - iii) the location and type of control signs;
 - iv) the route to be taken by vehicles or powered mobile equipment;
 - v) the priority to be established for classes of vehicle;
 - vi) the location and type of barriers or restricted area; and
 - vii) the duties of workers and the employer or contractor.
- (8) A worker who operates a vehicle or unit of powered equipment at a place of employment and who does not have a clear view of the path to be traveled shall not proceed until a person who has a clear view of the path to be travelled by the vehicle or unit of powered mobile equipment signals to the worker that it is safe to proceed.
- (9) Where a provision of this section conflicts with a provision of the *Highway Traffic Act*, the *Highways and Transportation Act, 1997*, the *Vehicle Administration Act*, and a regulation made pursuant to any of those Acts or a bylaw of a municipality made pursuant to

Section:
FUNDAMENTALS OF WORK ZONE
TRAFFIC CONTROL

Subject:
STATUTES AND REGULATIONS

the *Urban Municipality Act, 1984*, the *Rural Municipality Act, 1989* or the *Northern Municipalities Act*, the provision of the other statute, regulation or bylaw prevails.

- (10) Nothing in this section applies to a peace officer in the performance of the peace officer's duties.

TRAFFIC CONTROL DEVICES
MANUAL FOR WORK ZONES

Section: FUNDAMENTALS OF WORK ZONE
TRAFFIC CONTROL

Subject: SPEEDS

SUMMARY

Special care must be taken when designing sign placement so that vehicle speed is safely reduced from normal highway speed to the restricted speed levels required in work zones.

Speed control misuse at a work zone can damage the credibility of work zone speed reduction efforts. Misuse practices include such things as unreasonably low speed limits and leaving reduced speed limits in place after the work activity has been completed.

STATUTORY
PROVISIONS

There are statutory provisions and authorities for establishing maximum speed limits on provincial highways or any portion thereof.

Verbatim Sections of Acts referred to below are included in the "Statutes and Regulations" document in the Manual.

- General

Section 199 of *The Traffic Safety Act* stipulates that the maximum speed on any highway is 80 km/h unless otherwise posted. This section also has provision to intervene if normal traffic flow is impeded by vehicles travelling too slowly.

- Speed Zones and Signs

Section 20(1) of the *Highways & Transportation Act, 1997* makes provision for establishing speed zones on provincial highways and detours by erection of official signs indicating the maximum speed that applies.

Section 201 of *The Traffic Safety Act* stipulates that vehicles travelling within a speed zone established by official signs indicating the maximum speed shall not exceed the posted speed.

- Speed When Passing a Highway Worker

Section 203(1) of *The Traffic Safety Act* stipulates a 60 km/h maximum speed for vehicles "when passing a highway worker or flagperson or any equipment occupied by a highway worker whose presence is marked in accordance with regulations" made by the Highway Traffic Board. *The Highway Worker Identification Regulations* are included in the "Statutes and Regulations" document in TCDM 303.

Section:
FUNDAMENTALS OF WORK ZONE
TRAFFIC CONTROL

Subject:
SPEEDS

**MAXIMUM SPEEDS IN
WORK ZONES**

Each project needs to be assessed to determine if a speed restriction other than the maximums stipulated in current statutory provisions is required.

Some of the factors to be considered in determining appropriate maximum speeds include traffic volumes, the normal highway speeds in the vicinity of the work zone, the distance affected by the work zone, the time required to complete the work, the nature and complexity of the work and the highway alignment in the work zone.

Transitional Speed Areas

Transitional speed areas used to reduce travellers speed gradually and prepare them to make proper decisions when approaching the work zone. Transitional speed areas will be used on construction or maintenance projects after an assessment of the road and traffic composition has been completed.

**AUTHORITY TO SET
SPEED LIMITS**

Delegated authority of work zone speed control can be found in the Ministry's *Non-Financial Signing Authority Delegation Document*.

TRAFFIC CONTROL DEVICES
MANUAL FOR WORK ZONES

Section: FUNDAMENTALS OF WORK ZONE
TRAFFIC CONTROL

Subject: TEMPORARY REGULATORY
SPEED SETTING

SUMMARY

Temporary regulatory speed zones shall be implemented in all work zones. Authority to set temporary speed limits in a work zone is delegated to the Traffic Accommodation Supervisor (TAS). Speed zones are to be removed when the work area is inactive.

BACKGROUND

The Ministry gives authority to temporarily set the regulatory speeds as listed in the *Non-Financial Signing Authority Delegation* Document. Table 1.1 shows the minimum level of authority that an approver has based on a specific activity:

Table 1.1 – Non-Financial Signing Authority Delegation for Work Area Speed Control

Activity	Recommendations	Delegated Authority to Implement
Work Zone Speed Control – Temporary 60km/hr Regulatory Signs (RB-1)⁽⁸⁾		
Construction & Design Activities without an on-site Contractor		
MHI		Traffic Accommodation Supervisor
Consultant		Traffic Accommodation Supervisor
Activities with a Contractor on-site		
Where a Minor Contract form was used (Plan prepared by MHI)		Signatory
All other Contracts		Traffic Accommodation Supervisor
Ministry Staff		Traffic Accommodation Supervisor
Permits (Plan prepared by MHI)		Permittee

Position delegated to implement must hold a current certificate as a Traffic Accommodation Supervisor except where the sign plan is prepared by MHI.

Section:
FUNDAMENTALS OF WORK ZONE
TRAFFIC CONTROL

Subject:
TEMPORARY REGULATORY
SPEED SETTING

ENFORCEMENT

The Temporary Regulatory Speed Limit Sign-off sheets shall be used when installing a temporary regulatory speed sign to ensure that it is properly enforced.

The sign will be removed if a temporary speed sign is installed without proper documentation or by a non-approved authority.

DOCUMENTATION

All documentation of the Work Area Speed Control – Temporary Regulatory Speed Signs Approval Sheet shall be submitted to the project manager upon request and at the end of the project copies of these documents shall be submitted in the final report.

PROCEDURE

The CS-46C sign shall be removed or covered if workers or equipment are not present.

In situations where a hazard remains on the road surface when workers or equipment are not present the 60 km/hr sign can remain. The 'FINES TRIPLE' portion of the sign must be covered.

Existing permanent regulatory speed signs that are located in the Work zone shall be covered so that the temporary regulatory Speed sign does not conflict with it.

A higher temporary work zone speed limit shall not be installed where a lower permanent speed limit exists:

Example: Do not install a temporary 60 km/hr speed sign where a permanent speed limit of 40 km/hr already exists.

CS-46C may be produced in speed increments of 10 km/hr: 60 km/hr, 50 km/hr, 40 km/hr, 30 km/hr, etc.

Section: FUNDAMENTALS OF WORK ZONE
TRAFFIC CONTROL

Subject: TEMPORARY REGULATORY
SPEED SETTING

SPEED LIMIT MANAGEMENT GUIDANCE FOR WORK ZONES

Speed Limit (km/hr)					Description
<60	60	80	100	110	
X					<ul style="list-style-type: none"> When hazards are present that requires vehicles to travel slower than the recommended work zone speed limit of 60 km/hr. The speed limit selected will be based on engineering judgment. Proper approval must be given by the project manager before the speed limit is implemented.
	X				<ul style="list-style-type: none"> Regular Work Zones with a reduced speed regulatory sign. When passing equipment that has its ministry issued warning lights in operation, whether it is in motion or not. When passing a highway worker or flag person. The presence of workers/equipment is within 10 m of the edge of shoulder. In a work zone where there is less than 3.0 km between work areas and conditions do not allow for an increased speed. When passing a highway vehicle with emergency flashing lights on a two lane highway.
		X			<ul style="list-style-type: none"> When the reduction in speed results in a difference of 20 km/h or greater from the preceding zone or when engineering judgment is deemed necessary. Transition speed when approaching work zones on 2/4 lane 'high exposure' construction projects on the National Highway System. When travelling between work areas within a work zone and there is greater than 3.0 km between the work areas and conditions are allowable for an increased speed.
			X		<ul style="list-style-type: none"> All work is outside 10 m of the shoulder of the roadway for a two lane highway that is posted at 100 km/hr. When travelling between work areas on a two lane highway within a work zone and there is greater than 3.0 km between the work areas and conditions are allowable for an increased speed. Regular two lane highway conditions are present with no adverse geometric or road conditions identified.
				X	<ul style="list-style-type: none"> All work is 10 m off the shoulder of pavement for a multi-lane highway. When travelling between work areas on a multi-lane highway within a work zone and there is greater than 3.0 km between the work areas and conditions are allowable for an increased speed. Regular multi-lane highway conditions are present with no adverse geometric or road conditions identified.

Section: FUNDAMENTALS OF WORK ZONE TRAFFIC CONTROL

Subject: TEMPORARY REGULATORY SPEED SETTING

Work Area Speed Control – Temporary Regulatory Speed Limit Sign-off Sheet

PROCEDURE: SHALL BE FILLED OUT WHEN CS-46C IS USED INCONJUNCTION WITH IS-82 ‘PHOTO ENFORCED’ SIGN. REFER TO TCDMWZ 906.

CONTRACT NO: _____

DATE: _____
(MM/DD/YYYY)

TIME OF INSTALLATION	TIME OF SIGN REMOVAL	LOCATION*	INSTALLED SIGN CODE AND SPEED**	DIRECTION OF TRAVEL	SIGN-OFF INITIALS
<input type="checkbox"/> A.M. <input type="checkbox"/> P.M.	<input type="checkbox"/> A.M. <input type="checkbox"/> P.M.	<input type="checkbox"/> i) <input type="checkbox"/> ii) _____ _____	<input type="checkbox"/> RB-1 & _____ KM/H <input type="checkbox"/> CS-46C	<input type="checkbox"/> NORTH <input type="checkbox"/> SOUTH <input type="checkbox"/> EAST <input type="checkbox"/> WEST	
<input type="checkbox"/> A.M. <input type="checkbox"/> P.M.	<input type="checkbox"/> A.M. <input type="checkbox"/> P.M.	<input type="checkbox"/> i) <input type="checkbox"/> ii) _____ _____	<input type="checkbox"/> RB-1 & _____ KM/H <input type="checkbox"/> CS-46C	<input type="checkbox"/> NORTH <input type="checkbox"/> SOUTH <input type="checkbox"/> EAST <input type="checkbox"/> WEST	
<input type="checkbox"/> A.M. <input type="checkbox"/> P.M.	<input type="checkbox"/> A.M. <input type="checkbox"/> P.M.	<input type="checkbox"/> i) <input type="checkbox"/> ii) _____ _____	<input type="checkbox"/> RB-1 & _____ KM/H <input type="checkbox"/> CS-46C	<input type="checkbox"/> NORTH <input type="checkbox"/> SOUTH <input type="checkbox"/> EAST <input type="checkbox"/> WEST	
<input type="checkbox"/> A.M. <input type="checkbox"/> P.M.	<input type="checkbox"/> A.M. <input type="checkbox"/> P.M.	<input type="checkbox"/> i) <input type="checkbox"/> ii) _____ _____	<input type="checkbox"/> RB-1 & _____ KM/H <input type="checkbox"/> CS-46C	<input type="checkbox"/> NORTH <input type="checkbox"/> SOUTH <input type="checkbox"/> EAST <input type="checkbox"/> WEST	
<input type="checkbox"/> A.M. <input type="checkbox"/> P.M.	<input type="checkbox"/> A.M. <input type="checkbox"/> P.M.	<input type="checkbox"/> i) <input type="checkbox"/> ii) _____ _____	<input type="checkbox"/> RB-1 & _____ KM/H <input type="checkbox"/> CS-46C	<input type="checkbox"/> NORTH <input type="checkbox"/> SOUTH <input type="checkbox"/> EAST <input type="checkbox"/> WEST	

ADDITIONAL COMMENTS: _____

SIGNED BY (CHECK SIGNING AUTHORITY): _____

*LOCATION SHALL BE RECORDED IN ONE OF TWO WAYS:

- i) BY LATITUDE AND LONGITUDE GPS COORDINATES OR
- ii) BY CONTROL SECTION AND STATION/KM

**RB-1 (SPEEDS MAY VARY) -



**CS-46C -



Section: FUNDAMENTALS OF WORK ZONE
TRAFFIC CONTROL

Subject: TEMPORARY REGULATORY
SPEED SETTING

Work Area Speed Control – Temporary Regulatory Speed Limit Sign-off Sheet

PROCEDURE: SHALL BE USED WHEN RB-1 (SPEEDS MAY VARY) IS POSTED WHEN WORKERS ARE NOT PRESENT AND A HAZARD EXISTS ON THE ROADWAY.

CONTRACT NO: _____

DATE: _____
(MM/DD/YYYY)

TIME OF INSTALLATION	TIME OF SIGN REMOVAL	LOCATION*	INSTALLED SIGN CODE AND SPEED**	DIRECTION OF TRAVEL	SIGN-OFF INITIALS
<input type="checkbox"/> A.M. <input type="checkbox"/> P.M.	<input type="checkbox"/> A.M. <input type="checkbox"/> P.M.	<input type="checkbox"/> i) <input type="checkbox"/> ii) _____ _____	RB-1 & _____ KM/H	<input type="checkbox"/> NORTH <input type="checkbox"/> SOUTH <input type="checkbox"/> EAST <input type="checkbox"/> WEST	
<input type="checkbox"/> A.M. <input type="checkbox"/> P.M.	<input type="checkbox"/> A.M. <input type="checkbox"/> P.M.	<input type="checkbox"/> i) <input type="checkbox"/> ii) _____ _____	RB-1 & _____ KM/H	<input type="checkbox"/> NORTH <input type="checkbox"/> SOUTH <input type="checkbox"/> EAST <input type="checkbox"/> WEST	

ADDITIONAL COMMENTS: _____

SIGNED BY (CHECK SIGNING AUTHORITY): _____

*LOCATION SHALL BE RECORDED IN ONE OF TWO WAYS:

- i) BY LATITUDE AND LONGITUDE GPS COORDINATES OR
- ii) BY CONTROL SECTION AND STATION/KM

**RB-1 (SPEEDS MAY VARY) -



THIS PAGE INTENTIONALLY LEFT BLANK

TRAFFIC CONTROL DEVICES MANUAL FOR WORK ZONES

Section:

SIGNS

Subject:

CLASSIFICATION OF SIGNS

CLASSIFICATIONS

Work zone signs fall into three major classifications:

1. Temporary Warning Signs
2. Regulatory Signs
3. Information and Guide Signs

TEMPORARY WARNING SIGNS

- Function

Temporary warning signs for work zone projects are the most important signs used to notify drivers of specific hazards which may be encountered when those operations are underway.

- Design

Warning signs for work zones are generally diamond shaped and have an orange reflective background with a black symbol and/or legend message and black sign border.

- Dimensions

The minimum dimensions of temporary warning signs is 90 cm x 90 cm. Larger signs may be considered for long term or complex work zones. When the sign interferes with the operation of the vehicle, other sizes may be considered when used in conjunction with other devices.

REGULATORY SIGNS

- Function

Regulatory signs impose legal obligations and/or restrictions on all traffic. While provisional control of traffic will ordinarily be accomplished through warning signs, there are temporary conditions of traffic situations in work zones where the use of regulatory signs becomes necessary.

- Design

Regulatory signs, with some exceptions, such as the Stop sign, Yield sign and Do Not Enter sign are rectangular and fully reflective.

- Dimensions

Regulatory signs shall be of the same minimum dimensions as described in SK TCDM 400.

Section:**SIGNS****Subject:****CLASSIFICATION OF SIGNS****INFORMATION AND GUIDE SIGNS**

- **Function** Reference to information signs in this document is limited to their application for guiding traffic through portions of roadway where work zone activities may otherwise create confusion.
- **Design** Information and guide signs with few exceptions have a rectangular shape with the longer dimension being horizontal. They show a white legend on a green background.
- **Dimensions** The size and dimensions of information signs shall be as described in SK TCDM 400.

TRAFFIC CONTROL DEVICES
MANUAL FOR WORK ZONES

Section:

SIGNS

Subject:

SIGNING CATEGORIES

GENERAL

Three main categories of signing are used with regard to location of traffic control devices in work zones:

1. Advance Signing;
2. Approach Signing;
3. Work Site Signing.

ADVANCE SIGNING

This category includes all the signs used to give advance notice to motorists of an activity or road obstruction ahead. This type of signing does not require an immediate reaction from the driver.

APPROACH SIGNING

This category includes the warning and regulatory signs placed at the immediate approach to the work site requiring reaction by the road user.

Approach signing shall inform the motorists of any required action.

WORK SITE SIGNING

This category includes the warning signs required to advise the motorist of activities or obstructions. Regulatory and information signs shall be erected at the work site as required to advise and guide the motorists.

TRAFFIC CONTROL DEVICES
MANUAL FOR WORK ZONES

Section:

SIGNS

Subject:

SIGN INSTALLATION & PLACEMENT
LATERAL AND VERTICAL POSITION

LATERAL POSITION

• Single Post Fixed Signs

Signs shall be located on the right hand side of the roadway with the near edge from 0.3 m to 4.5 m from the edge of the shoulder line.

Signs 120 cm or less in width may be erected on single posts.

• Double Post Fixed Signs

Signs shall be located on the right hand side of the roadway with the near edge of the sign from 2.0 m to 4.5 m from the edge of the shoulder line.

Signs exceeding 120cm in width and/or exceeding an area of 1.44 square m in area shall be erected on two posts.

• Portable Signs

Signs shall be located on the right hand side of the roadway with the near edge of the sign from 0.3 m to 4.5 m from the edge of the shoulder line.

• General Requirements

Single and double post mounted signs should be used for long duration work.

The lateral position of fixed signs and portable signs is shown on pages 3 and 4 of TCDMWZ 403.

VERTICAL POSITION

• Single and Double Fixed Signs

The signs shall be erected to a height of between 0.45 m and 2.5 m above the travelled portion of the roadway and the bottom edge of the lowest sign.

• Portable Signs

The signs shall be erected to a height of between 0.45 m and 2.5 m above the travelled portion of the roadway and the bottom edge of the lowest sign.

The vertical position of fixed signs and portable signs is shown on pages 3 and 4 of TCDMWZ 403.

Section:

SIGNS

Subject:SIGN INSTALLATION & PLACEMENT
LATERAL AND VERTICAL POSITION**PORTABLE STANDS**

Signs mounted on portable stands or barricades are suitable for temporary conditions. Positioning of the portable stand is illustrated on page 4 of TCDMWZ 403.

All signs shall be mounted such that the sign face is positioned and oriented towards traffic. The stand should yield upon impact to minimize hazards to motorists.

SIGN MOUNTED ON VEHICLE

For certain operations, a large sign may be effectively mounted on a vehicle stationed in advance of the work or moving along with the work. This may be the working vehicle itself or a vehicle provided expressly for this purpose.

**SIGN MOUNTED ON
BARRICADE**

Detour signs, although ordinarily erected on separate posts, may also be mounted on or above barricades, but should not be permitted to interfere with the effectiveness of necessary regulatory and warning signs.

ROLL UP SIGNS

Roll up signs on portable stands are suitable for temporary conditions, providing the sign meets the size, shape, colour and reflectivity as described in TCDMWZ 404.

Section:

SIGNS

Subject: SIGN INSTALLATION & PLACEMENT
LATERAL AND VERTICAL POSITION
LONG DURATION

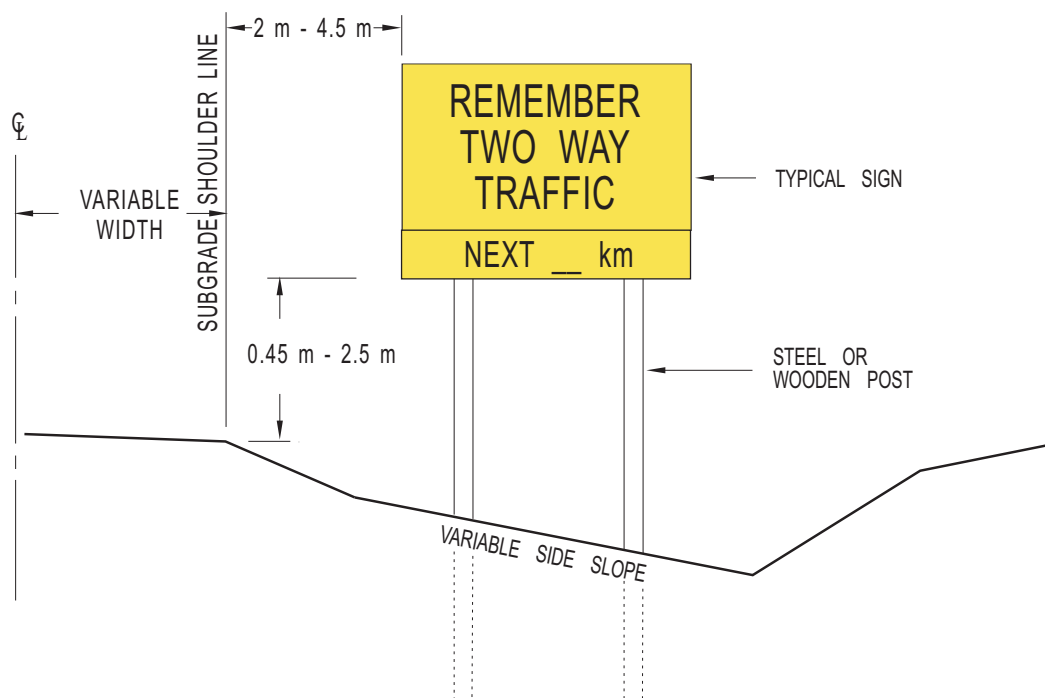
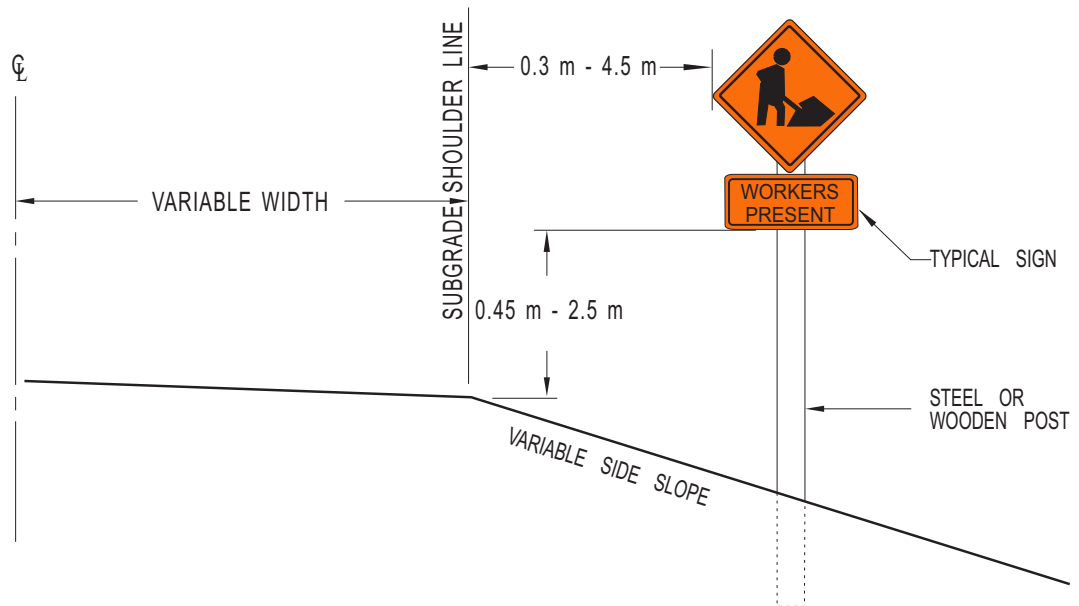

Date

2009-08-25

Page

3 of 4

Section:

SIGNS

Subject: SIGN INSTALLATION & PLACEMENT
LATERAL AND VERTICAL POSITION
SHORT DURATION

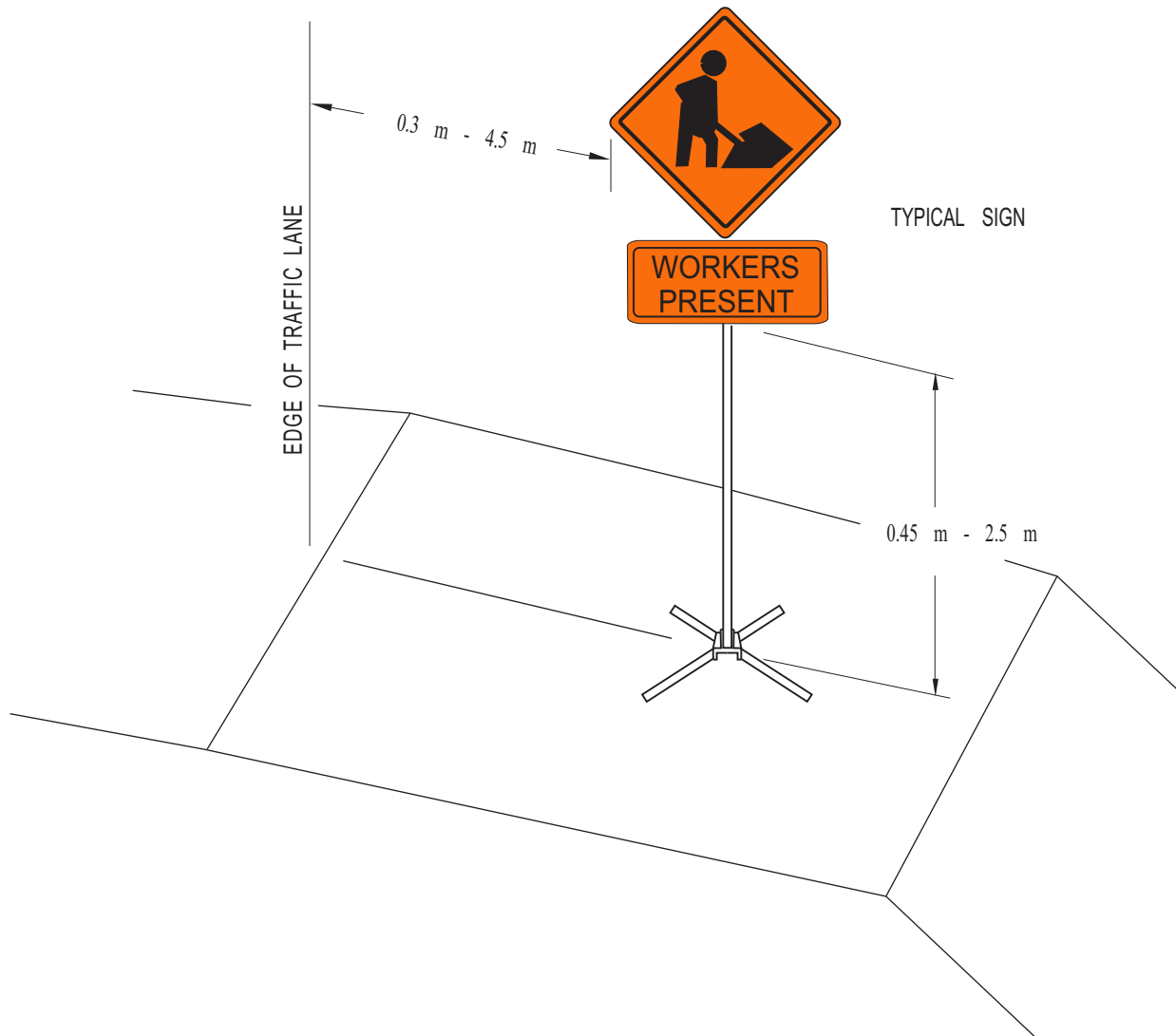

TRAFFIC CONTROL DEVICES
MANUAL FOR WORK ZONES

Section:

SIGNS

Subject:

SIGN DESCRIPTION

SUMMARY

This section provides a description and use for the signs most commonly used in roadway work operations.

Work zone signs fall into the same major categories, as do other traffic signs: regulatory, warning and guide/information. Many traffic signs normally used elsewhere will also find application for signing in work zones. Temporary warning signs in work zones have a black legend and an orange background colour. Other signs follow the normal standards.

The use of standard flags or flashing amber lights in conjunction with signs is permitted provided these devices do not interfere with the motorist's view of the sign face.







TRAFFIC CONTROL DEVICES
MANUAL FOR WORK ZONES

Section:

SIGNS

Subject:

SIGN DESCRIPTION
REGULATORY

CODE	SIGN	SIZE (cm)	COLOUR MESSAGE	BGRD	DESCRIPTION	SPEC
RA-1		75 x 75	White	Red	Stop Indicates to drivers facing the sign to stop completely and not to proceed until it is safe to do so.	245S
RA-2		75x75x 75	Red	White	Yield Indicates to drivers facing the sign to yield the right of way, stopping if necessary before entering the intersection area, and not proceed until it is safe to do so.	245S
RB-1		60x75	Black	White	Maximum Speed Indicates to motorists the maximum legal vehicle speed which is permitted on the roadway section indicated by the presence of the signs. The maximum speed in kilometres per hour, as established by law, and shown in multiples of 10 km/h.	245S
RB-5		60x75	Black	White	Maximum Speed Ahead Indicates to motorists that they are approaching a section of roadway upon which the statutory speed limit is reduced. Is always followed by the Maximum Speed sign (RB-1) at a distance of not less than 90 nor more than 150 m.	245S
RB-11R/L		60x60	Black	White	No Right Turn (Left)	240
RB-16		60x60	Black	White	No U Turns	240
RB-23		75x75	Red	White	Do Not Enter	245S

Section:

SIGNS

Subject:

SIGN DESCRIPTION
REGULATORY





CODE	SIGN	SIZE (cm)	COLOUR MESSAGE BGRD	DESCRIPTION	SPEC	
RB-24		60x75	Black	White	Two Way Traffic Installed to advise motorists they are about to enter a two way roadway. Placed on each side of the roadway at the beginning of the section where two way traffic is permitted.	245S
RB-25		60x75	Black	White	Keep Right Installed in the gore point at the transition from two lane to four lane highway and face the motorist travelling along the two lanes highway towards the four lane highway.	245S
RB-31		75x75	Black	White	Do Not Pass Installed to warn motorists that passing would be hazardous due to lane closures or windrowed material.	245S
RB-32		75x75	Black	White	Passing Permitted May be installed at the end of a no passing zone where a Do Not Pass sign has been installed at the beginning.	240
RB-61		75x75	Black	White	Truck Route	245S
RB-62		75x75	Black	White	Truck Prohibition	245S
RB-63		60x60	Black	White	Weight Limit Control	245S
RB-151		60x60	Black	White	Rural Parking Control	240
RB-155		60x60	Black	White	Rural Stopping Control	240

Section:

SIGNS

Subject:

SIGN DESCRIPTION
REGULATORY

CODE	SIGN	SIZE (cm)	COLOUR MESSAGE BGRD	DESCRIPTION	SPEC
RC-4R/L		60x75	Black	White	Stop Line Right (Left) 240
RS-25		240x120	Black	White	Highway Closed Ahead Installed to indicate to the motorist that the road is closed due to a hazardous condition. 245S
RS-26		120x75	Black	White	Road Closed Installed where a road is closed entirely to public traffic. 245S
RS-27		150x75	Black	White	Road Closed To Thru Traffic Installed where a road is closed entirely to public traffic. 245S
RS-28		240x120	Black	White	Highway ___ Closed ___ km Ahead Should be installed to advise motorists that a certain highway is closed to traffic beyond a certain point. 245S

The route numbers and kilometres can be ordered separately in the form of E Series decals so that the signs can be used at various locations.

Date

2009-08-25

Page

3 of 3









TRAFFIC CONTROL DEVICES
MANUAL FOR WORK ZONES

Section:

SIGNS

Subject:

SIGN DESCRIPTION
WORK ZONE

CODE	SIGN	SIZE (cm)	COLOUR MESSAGE	BGRD	DESCRIPTION	SPEC
ID-B5L/R		45x30	Black	Orange	Detour Arrow - 90 degrees Left (Right) Shall be installed in conjunction with a Route Marker to form an assembly to give advance information on a turn or change in the direction of a route.	240
ID-B7		45x30	Black	Orange	Detour Arrow – Vertical See ID - B5	240
ID-B8		45x30	Black	Orange	Detour Arrow – Horizontal See ID-B5	240
ID-B9R/L		45x30	Black	Orange	Detour Arrow - 45 degrees Right (Left) See ID-B5	240
GSD-1		45x30	Black	Orange	Detour Arrow – Doubleheaded	240
GSD-2R/L		45x30	Black	Orange	Detour Arrow – Doubleheaded Right Angle (Left)	240
WD-A1R/L		90x90	Black	Orange	Right (Left) Turn (90 degrees)	240
WD-A2R/L		90x90	Black	Orange	Right (Left) Curve (90 degrees)	240

Section:





SIGNS

Subject:





SIGN DESCRIPTION
WORK ZONE

CODE	SIGN	SIZE (cm)	COLOUR MESSAGE BGRD	DESCRIPTION	SPEC
WD-A3L		90x90	Black Orange	Left (Right) Curve	240
WD-A4R/L		90x90	Black Orange	Right (Left) Reverse Turn	240
WD-A5R/L		90x90	Black Orange	Right (Left) Reverse Curve	240
WD-A6R/L		90x90	Black Orange	Right (Left) Winding Road	240
WD-A7		60x60	Black Orange	Advisory Speed Tab Shall be installed in conjunction with standard warning signs.	240
WD-A8		90x90 120x120	Black Orange	Checkerboard (dead-end)	240
WD-A8B		90x90 120x120	Black Orange	Checkerboard (Doubleheaded Horizontal Arrow)	240







Section:	SIGNS	Subject:	SIGN DESCRIPTION WORK ZONE
-----------------	--------------	-----------------	---------------------------------------

CODE	SIGN	SIZE (cm)	COLOUR MESSAGE BGRD	DESCRIPTION	SPEC
WD-A8L/R		90x90 120x120	Black Orange	Checkerboard (turn left or right)	240
WD-A9		45x60 60x75	Black Orange	<p>Chevron Alignment Shall be installed to provide additional guidance for motorists as to changes in the horizontal alignment due to lane closures and highway diversions.</p> <p>Shall be installed on the outside of a curve or sharp turn and along the taper for a lane closure. The signs shall be located at right angles to oncoming traffic. The spacing of the signs should be such that the motorist always has two in view until the change in alignment eliminates the need for the signs.</p> <p>Should be installed at a height of 1.2 m above the near edge of the nearest traffic lane to the bottom of the sign.</p>	240
WD-A14		90x90	Black Orange	T Intersection	240
WD-A18		90x90	Black Orange	Railway Advance Warning	240
WD-A18R/L		90x90	Black Orange	Railway Advance Warning (45 degrees Right/Left)	240





Section:	SIGNS	Subject:	SIGN DESCRIPTION WORK ZONE
-----------------	--------------	-----------------	---------------------------------------

CODE	SIGN	SIZE (cm)	COLOUR MESSAGE BGRD	DESCRIPTION	SPEC
WD-A22		90x90	Black Orange	Bump Shall warn of a sharp change in the profile of the road that is sufficiently abrupt to create a hazardous condition, to cause considerable discomfort to passengers, to cause a shifting of cargo, or to deflect a vehicle from its true course when the bump is crossed at speeds 25% greater than normal driving speed for that section of the road.	240
WD-A23		90x90	Black Orange	Road Narrows Shall indicate in advance a reduction in the width of the roadway but only in cases where no reduction occurs in the number of traffic lanes.	240
WD-A23 L/R		90x90	Black Orange	Road Narrows Left (Right)	240
WD-A24		90x90	Black Orange	Narrow Structure Shall indicate in advance a structure (bridge, culvert, subway, overpass and similar structures) having a clear roadway width of 5 to 6 m inclusive, or any structure with a roadway clearance less than the width of the approach pavement. Where the structure has a clear roadway width of less than 5 m thereby permitting only a single lane of traffic, a One Lane tab (WD-A24T) shall be added immediately below the narrow structure sign.	240
WD-A24T		75x45	Black Orange	One Lane	240





Section: SIGN	Subject: SIGN DESCRIPTION WORK ZONE
-------------------------	--

CODE	SIGN	SIZE (cm)	COLOUR MESSAGE BGRD		DESCRIPTION	SPEC
WD-A25		90x90	Black	Orange	Pavement Ends Shall indicate that an asphalt or concrete roadway is about to end and that its continuation has a gravel surface.	240
WD-A28S		60x45	Black	Orange	Next ___ km Shall indicate how many kilometres a motorist should expect work zone activity on the highway. The Numbers 0 to 9 sign tab (WD-A28T) should be used in conjunction with the Next ___ km sign to indicate the length of the temporary condition.	240
WD-A28T		10x15	Black	Orange	Numbers 0 to 9 for WD-A28S	240
WD-A31		90x90	Black	Orange	Divided Highway Begins Shall be installed on the approaches to a section of a highway where the opposing flows of traffic are separated by a median, and shall indicate the transition from a non-divided to divided highway cross-section ahead.	240
WD-A32		90x90	Black	Orange	Divided Highway Ends Shall be installed at the end of a section of divided highway as a warning of two way traffic ahead, and shall indicate the transition from divided to non-divided highway cross-section ahead. Should be installed on both sides of the roadway.	240
WD-A33R/L		90x90	Black	Orange	Right (Left) Lane Ends Shall indicate in advance, on the approaches to work sites, that there is a temporary reduction in the number of traffic lanes either from the right or the left.	240





Section:	SIGNS	Subject:	SIGN DESCRIPTION WORK ZONE
-----------------	--------------	-----------------	---------------------------------------

CODE	SIGN	SIZE (cm)	COLOUR MESSAGE BGRD	DESCRIPTION	SPEC
WD-A41		90x90	Black Orange	<p>Roadwork Ahead Shall indicate that construction or maintenance activities are in progress upon or adjacent to the roadway and that workers or equipment may be exposed to the motorist.</p> <p>Shall always be installed first in the sequence of approach signs.</p> <p>Establishes the maximum speed of 60 km/h when passing highway workers or equipment engaged in roadwork per Section 203 (1) of <i>The Traffic Safety Act</i>. Refer to TCDM 303.</p> <p>The roadwork ahead sign shall be removed or covered if workers or equipment are not present.</p>	246S
WD-A41H		60x60	Black Orange	<p>Roadwork - Hinged</p>	240
WD-A41T		75x45	Black Orange	<p>Workers Present Shall only be used as a tab under the WD-A41 Roadwork Ahead Sign. Tab and sign shall be covered or removed if workers or equipment are not present.</p>	246S
WD-A43 R/L		90x90	Black Orange	<p>Roadside Diversion Right (Left) Shall indicate a minor deviation of the normal roadway. It shall be installed either as an advance sign or in the sequence of approach signs.</p>	240







Section:	Subject:
SIGNS	SIGN DESCRIPTION WORK ZONES

CODE	SIGN	SIZE (cm)	COLOUR MESSAGE BGRD	DESCRIPTION	SPEC	
WD-A44		45x30 74x30	Black	Orange	<p>Detour Shall indicate that motorists will be required to depart completely from their normal route to follow an alternate routing.</p> <p>Shall be repeated in any subsequent series of guide signs along the detour as necessary to properly advise the motorist of the temporary routing.</p> <p>When used with a route marker, the size should be 45 x 30 cm. When used with a warning sign, the size should be 75 x 30 cm.</p>	240
WD-A45		90x90	Black	Orange	<p>Flagperson Ahead Shall indicate a work area where a flagperson is on duty. Shall be installed last in the sequence of signs in advance of the flagperson.</p> <p>The flagperson sign shall be removed or covered if the flagperson is not present.</p>	246S
WD-A46		90x90	Black	Orange	<p>Survey Crew Shall indicate that surveying activities are in progress upon or adjacent to the highway and that workers or survey equipment may be exposed to the motorist.</p> <p>The survey crew sign shall be removed or covered if workers or equipment are not present.</p>	246S
WD-A48 R/L		90x90	Black	Orange	<p>Truck Entrance Right (Left) Shall indicate a location where trucks are entering or crossing the main roadway.</p>	240
WD-A49		90x90	Black	Orange	<p>Pavement Drop-Off Shall indicate to motorists that they are on or approaching a section of roadway where either or both the adjacent lane or shoulder are lower or higher than the motorists' travel lane.</p> <p>Sign when pavement drop-off exceeds 60mm.</p>	240



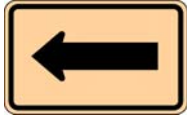

Section:	Subject:
SIGNS	SIGN DESCRIPTION WORK ZONE

CODE	SIGN	SIZE (cm)	COLOUR MESSAGE	BGRD	DESCRIPTION	SPEC
WD-A50		90x90	Black	Orange	Grooved Pavement Indicates that work activities create a surface condition which may affect the control and stability of vehicles. It shall be installed either as an advance sign or in the sequence of approach signs. The Next ___ km sign tab (WD-A28S) should be used in conjunction with the Grooved Pavement sign to indicate the length of this temporary condition.	240
WD-A50T		75x45	Black	Orange	Grooved Pavement Tab	240
WD-B1		90x90	Black	Orange	Stop Ahead Shall indicate the existence of a stop sign.	240
WD-B3		90x90	Black	Orange	Two-Way Traffic Ahead Shall indicate to motorists driving on a one way street or highway that they are approaching a section where two way traffic is in operation and that the normal rules of the road for the two way operation apply.	240
WD-B4		90x90	Black	Orange	Signals Ahead Shall indicate to motorists the existence of traffic control signals ahead and may generally be employed to the advantage of motorists where the signals are not visible for a distance of 120 m, or in such other cases where the prevailing approach speed or conditions of visibility are such as to justify its use. The sign tab (WD-B4T) may be used to indicate the distance to the traffic signal rounded to the nearest 50 m.	240

Section:	SIGNS	Subject:	SIGN DESCRIPTION WORK ZONE
-----------------	--------------	-----------------	---------------------------------------

CODE	SIGN	SIZE (cm)	COLOUR MESSAGE BGRD	DESCRIPTION	SPEC	
WD-C5		90x90	Black	Orange	<p>Slippery When Wet Shall indicate an extraordinarily slippery road surface condition. The use of this sign shall be kept to an absolute minimum and upon the correction of the slippery condition, the sign shall be removed.</p> <p>On rural highways, the sign shall be installed at not greater than 3 km intervals on long sections of slippery road surface.</p>	240
WD-S9		90x90	Black	Orange	<p>Watch For Rocks Should be installed when earth excavation containing rocks is placed on the subgrade.</p>	240
WD-S10		120x60	Black	Orange	<p>Large Directional Arrow</p>	240
WD-S28		90x90	Black	Orange	<p>Soft Shoulder Should be installed where soft shoulders present a hazard to vehicles that leave the pavement.</p> <p>Should be installed at regular intervals, about 300 m apart over short stretches and 900 m on long sections.</p>	240
WD-S90		90x90	Black		<p>Vinyl Sign Cover</p>	
CS-1		90x90	Black	Orange	<p>Begin Detour Shall be used ahead of a detour that directs traffic onto an alternate route in order to bypass the work zone. The sign when used should be placed 400 metres in advance of the start of the detour.</p>	240

Section:	SIGNS	Subject:	SIGN DESCRIPTION WORK ZONE
-----------------	--------------	-----------------	---------------------------------------

CODE	SIGN	SIZE (cm)	COLOUR MESSAGE BGRD	DESCRIPTION	SPEC
CS-2		90x90	Black Orange	Barricade Ahead	240
CS-3		90x90	Black Orange	End Detour 125 m Should be used to indicate the end of a detour. The sign when used should be placed 125 m in advance of the end of the detour.	240
CS-5		90x90	Black Orange	Be Prepared To Stop May be used to advise the motorist to be prepared to stop due to obstructions in the traveled way.	240
CS-6	See TC-17		Black Orange	Yield To Oncoming Traffic	
CS-7		90x90	Black Orange	Fresh Oil Shall be used to warn motorists of uncovered road oil on the highway surface, which could splash onto vehicles. The Fresh Oil sign shall remain until the surface can be traveled at normal speeds without splashing occurring. The Next ___ km sign tab (WD-A28S) should be used in conjunction with the Fresh Oil sign to indicate the length of this temporary condition.	240
CS-8		90x90	Black Orange	Rough Road Should be installed in advance to warn motorists of a rough section of road through a work zone. The Next ___ km sign tab (WD-A28S) should be used in conjunction with the Rough Road sign to indicate the length of this temporary condition.	240







Section: SIGN	Subject: SIGN DESCRIPTION WORK ZONE
-------------------------	--

CODE	SIGN	SIZE (cm)	COLOUR MESSAGE BGRD		DESCRIPTION	SPEC
CS-9		90x90	Black	Orange	Loose Gravel Should be installed to warn motorists that there is loose gravel on the highway. The Next__km sign tab (WD-A28S) should be used in conjunction with the Loose Gravel sign to indicate the length of this temporary condition.	240
CS-10		120x60	Black	Orange	Detour Next __km Shall be installed to warn motorists of an upcoming detour. The Numbers 0 to 9 sign tab (WD-A28T) should be used in conjunction with the Detour Next__km sign to indicate the length of the detour.	240
CS-11L/R		120x75	Black	Orange	Road Closed Detour Left (Right) Shall be used where a road is closed to through traffic. The arrow is used to indicate the direction of an alternate route for through traffic around a closed section of highway.	240
CS-12R		240x24	Black	Orange	Barricade Board Right Shall be used in conjunction with the Barricade Stands to form a Standard Barricade. The stripes are placed at 45 degrees on the boards. Two boards can be placed together to form an arrow head to indicate direction.	156
CS-12L		240x24	Black	Orange	Barricade Board Left See CS-12R	156
CS-13			White		Barricade Stand (pair) Used in conjunction with the Barricade Boards to form a Standard Barricade.	
CS-14		75x75	Black	Orange	End Of Work Zone Shall be installed at the outer limits of construction zone as the driver is leaving the construction zone.	240





Section:	SIGNS	Subject:	SIGN DESCRIPTION WORK ZONE
-----------------	--------------	-----------------	---------------------------------------

CODE	SIGN	SIZE (cm)	COLOUR MESSAGE BGRD	DESCRIPTION	SPEC	
CS-16		60x75	Black Orange	End Of Work Area Installed beyond the end of a work area where the work is being undertaken. This sign is not intended to replace the CONSTRUCTION ENDS sign, which is installed at the limits of construction.	240	
CS-16H		60x75	Black Orange	End Of Work Area - Hinged	240	
CS-17		90x90	Black Orange	Overhead Lines Should be installed up to 10m in advance of the overhead line to give warning to truckers that their raised boxes might come in contact with overhead lines.	240	
CS-18A & CS-18B		120x120 120x120	White Green White Green	Alternate Route Map (message) Alternate Route Map (map) May be installed when travel through the work zone cannot be ensured at the designated class of traffic accommodation.	210 210	
CS-19		240x120	White Green	Alternate Route Map 150m Ahead Shall be installed only in conjunction with an Alternate Route Map sign (CS-18).	220	
CS-20		120x120	Black Orange	Traffic Being Assisted	240	
CS-21		330x180	Black/ Green	White/ Green	Work Zone Courtesy Shall be installed only on those highway projects that have a value greater than \$3,000,000.	240



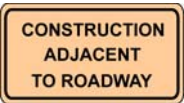

Section: SIGNS	Subject: SIGN DESCRIPTION WORK ZONE
---------------------------------	--

CODE	SIGN	SIZE (cm)	COLOUR MESSAGE BGRD	DESCRIPTION	SPEC
CS-23		15x60 30x90	Black Orange	Work Zone Delineator May be used to delineate detours, windrows, shoulder widening, sharp drop off pavement edge and to channelize traffic along a specified route. May also be used to mark tapers in advance of closed lanes and to provide separation between work zones and the flow of traffic.	146
CS-26N	 FRONT BACK	45x45		Hand Paddle with no Handle Shall be used by flagpersons to indicate the appropriate instruction to motorists approaching a work site.	335
CS-26S		45x45		CS-26N Hand Paddle with 30 cm handle	335
CS-26L		45x45		CS-26N Hand Paddle with 150 cm handle	335
CS-27R		240x24	Black Orange	Keep Right Shall be the top board when used in conjunction with the Barricade Stands to form a Standard Barricade to signify keep right	156
CS-27L		240x24	Black Orange	Keep Left See CS-27R	156
CS-28		90x90	Black Orange	Loose Stones Should be installed on seal coat projects or other areas to warn motorists that there are loose stones on the highway surface. The Next ___ km sign tab (WD-A28S) should be used in conjunction with the Loose Stones sign to indicate the length of this temporary condition.	240
CS-29		90x90	Black Orange	Blasting Area Ahead	240









Section:	Subject:
SIGN	SIGN DESCRIPTION WORK ZONE

CODE	SIGN	SIZE (cm)	COLOUR MESSAGE BGRD		DESCRIPTION	SPEC
CS-30		90x90	Black	Orange	Bridge Repair Ahead	240
CS-32		164x50	Black	Orange	Pilot Vehicle - Follow Me Shall be mounted on a pilot vehicle where it is required to lead motorists through a work area.	246A
CS-33		90x90	Black	Orange	Work Zone Ahead Shall be installed to provide advance warning of a Long Duration work zone. The Work Zone Ahead sign can be used to identify the presence of the upcoming work zone.	246S
CS-34		180x90	Black	Orange	Work Zone Adjacent To Roadway May be installed to inform motorists of work adjacent to the roadway. The Next ___ km sign tab (WD-A28S) should be used in conjunction with the Construction Adjacent To Roadway sign to indicate the length of this temporary condition.	240
CS-35R/L		90x90	Black	Orange	Squeeze Left (Right)	240
CS-36		90x90	Black	Orange	Blowing Dust Should be installed to warn motorists of blowing dust conditions in or adjacent to the work area. The Next ___ km sign tab (WD-A28S) should be used in conjunction with the Blowing Dust sign to indicate the length of this temporary condition.	240

Section:	SIGNS	Subject:	SIGN DESCRIPTION WORK ZONE
-----------------	--------------	-----------------	---------------------------------------







CODE	SIGN	SIZE (cm)	COLOUR MESSAGE BGRD	DESCRIPTION	SPEC	
CS-38		245x30	White	Red	Wide Load "D"	240
CS-40		360x120	White	Blue	Orange Zone Awareness (Requires WD-A41) Not installed within the work zone. Department installed sign to raise public awareness of work zones.	240
CS-40B		360x120	White	Blue	Snow Zone Awareness (requires CS-40BT) Not installed within the work zone. Department installed sign to raise public awareness of work zones.	240
CS-40BT		90x90	Black	Yellow	Snow Zone Tab - (Part of CS-40B)	240
CS-41		120x60	Black	Orange	Slow Down And Save Your Windshield May be installed for temporary surface conditions to warn motorists of danger to their windshield due to loose stones on the highway.	240

Section:	SIGNS	Subject:	SIGN DESCRIPTION WORK ZONE
-----------------	--------------	-----------------	---------------------------------------

CODE	SIGN	SIZE (cm)	COLOUR MESSAGE	BGRD	DESCRIPTION	SPEC
CS-42		90x90	Black	Orange	Road Sweeper Ahead Should be installed to warn motorists of a road sweeping operation. May be installed as part of the sign assembly on a stripping unit.	240
CS-43		164x50	Black	Orange	Pass When Safe	246A
CS-44		164x50	Black	Orange	When Safe Pass As Shown Shall be mounted on the rear of a pilot vehicle, which follows the striper.	246A
CS-45		240x180	White	Blue	Joint Project	240
CS-45T		240x30	White	Blue	Joint Project Tab	240
CS-46C		60x120	Black	White	60 km/hr Fines Triple Shall be installed to advise motorists of the maximum legal speed in the work zone. Shall be removed or covered when worker are no longer present. In situations where a hazard remains when the workers are no longer present, the 60 km/hr sign may remain. The "Fines Triple" portion of the sign must be covered.	245S
CS-47		330x90	Black	Orange	Bridge Repairs Ahead Shall indicate to motorists that they may be approaching a stop condition. A tab shall be placed on the bottom of the sign giving the distance to the stop condition.	240
CS-47T		330x45	Black	Orange	Maximum Width _____ m The Numbers 0 to 9 sign tab (WD-A28T) should be used in conjunction with the Maximum Width ___ m sign to indicate the length of the temporary condition.	240
CS-48		240x120	Black		Flashing STOP Board Shall indicate to drivers facing the sign to stop their vehicles completely and not to proceed until it is safe to do so.	

The Flashing STOP Board consists of a 120x 120 cm STOP sign mounted on a 120 x 240 cm sheet of plywood painted black. Alternating flashing lights on each side of the STOP sign.

Section:	Subject:
SIGN	SIGN DESCRIPTION WORK ZONE

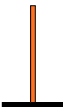
CODE	SIGN	SIZE (cm)	COLOUR MESSAGE BGRD	DESCRIPTION	SPEC
CS-49		60X45 75x45	Black Orange	Advisory Distance	240
CS-50		164x50	Black Yellow	Wet Paint Installed as part of the sign assembly on a stripping unit.	140
CS-56		3.8 cm	Black	Numbers (equipment identification) Decal	580
CS-57	 Ministry of Highways and Infrastructure	17x44	Black	Highway Crests (vehicle identification)	620
CS-58	Illustration Not Available	60x60	Black	Asphalt Tank Identification	220
CS-58A		60x60	Black	Asphalt Type Tab (for CS-58)	275
CS -63 & CS-64	Discontinued			Men Working/Fresh Oil	
CS-75		45 cm	Orange	Traffic Cone – 50 km/hr or less May be used to delineate detours, windrows, shoulder widening, sharp drop-off pavement edge and to channelize traffic along a specified route. They may also be used to mark tapers in advance of closed lanes and to provide separation between work zones and the flow of traffic.	
CS-76		70 cm	Orange	Traffic Cone – More than 50 km/hr See CS-75	
CS-77		100 cm	Orange	Traffic Delineator – More than 50 km/hr (weighted base) See CS-75	

Section: SIGNS	Subject: SIGN DESCRIPTION WORK ZONE
-----------------------	--

CODE	SIGN	SIZE (cm)	COLOUR MESSAGE BGRD	DESCRIPTION	SPEC
------	------	-----------	---------------------	-------------	------

CS-78



10 cm x Var.
Orange

Flexible Delineator
May be used to delineate detours, windrows, shoulder widening, sharp drop-off pavement edge and to channelize traffic along a specified route. They may also be used to mark tapers in advance of closed lanes and to provide separation between work zones and the flow of traffic.

CS-79

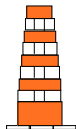

Variable Orange

Flexible Drum
Provides an alternative method to delineate detours, windrows, shoulder widening, sharp drop-off pavement edge and to channelize traffic along a specific route. May also be used to mark tapers in advance of closed lanes and to provide separation between work zones and the flow of traffic. Are generally used in situations where they will remain in place for prolonged periods of time.

CS-80



Raised Delineator

TC-17









75x45 Red White





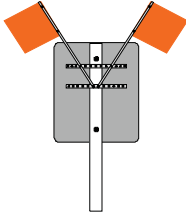

“TO ONCOMING TRAFFIC” tab 245S

**TRAFFIC CONTROL DEVICES
MANUAL FOR WORK ZONES**

Section:
SIGNS
Subject:
**SIGN DESCRIPTION
WARNING**

CODE	SIGN	SIZE (cm)	COLOUR MESSAGE BGRD	DESCRIPTION	SPEC
WS-13		90x90	Black Yellow	Gravel Sections	240
WS-16A		35x35x 35	Red Orange	Slow Moving Vehicle (small)	310
WS-16B		75x75x 75	Red Orange	Slow Moving Vehicle (large)	310
WS-18		120x150	Black Yellow	Advisory Exit Speed	245S
WS-21		45x45	Fluorescent	Metal Flags	273
WS-25		75x75	Black Yellow	Broken Pavement	245S

Section:	Subject:
SIGNS	SIGN DESCRIPTION WARNING

CODE	SIGN	SIZE (cm)	COLOUR MESSAGE BGRD	DESCRIPTION	SPEC
WS-30		90x90	Black Yellow	Heavy Truck Haul	245S
WS-53		240x120	Black Yellow	Remember Two Way Traffic Shall be installed to advise motorists that they are on a two way roadway and that the normal rules of the road for two way operation apply. Should be installed 800 m beyond the RB-24 sign (Two Way Traffic Sign) and placed every 3 km thereafter within the work zone. The sign tab Next ___ km (WD-53T) shall indicate the length of two-way traffic to be encountered by the motorists within the work zone.	245S
WS-53T		240x45	Black Yellow	NEXT ___ km Tab	245S
WS-54		270x120	Black Yellow	Highway Closed When Flashing	245S
WS-60		210x120	Black Yellow	Advance Runaway Truck Ramp	245S
WS-61		210x150	Black Yellow	Directional Runaway Truck Ramp	245S
WS-65		75x60	Black Yellow	Vehicle Backs Up	240

**TRAFFIC CONTROL DEVICES
MANUAL FOR WORK ZONES**

Section:

SIGNS

Subject:

MANUFACTURING SPECIFICATIONS

1. SIGN SUBSTRATE

➤ Plywood (1.27 cm)

All 1.27 cm plywood including splicing material will be medium density, overlay plywood (good both sides) and meet plywood manufacturing specifications CSA 0151.

➤ Plywood (1.9 cm):

All 1.9 cm sign blanks will be 240 cm x 24 cm, good one side fir plywood planks and meet manufacturing specifications CSA 0121.

➤ Aluminum (Flat type)

Aluminum sheet alloy will be Alcan S-67 sign sheet or approved equivalent. Thickness for signs 1.44 m² or less will be a minimum of 1.6 mm. Thickness for signs greater than 1.44 m² will be a minimum of 2.0 mm. Mechanical properties, minimum ultimate tensile strength of 2672 kg/cm², a typical yield strength of 2600 kg/cm²

2. SIGN FACING

All facing materials used are to be approved by the ministry. Sign facing colours to meet ATMP 4946-09 and retain the colour for the warranted life of the material.

➤ ASTM D4956 - 09 - Type IV (High Intensity Prismatic)

To meet reflective as per Specification

Board Standard ASTM D4956-09, Standard for:
Marking Material, Retroreflective Enclosed Lens,
Adhesive Backing.

(High Intensity)



Section:

SIGNS

Subject:

MANUFACTURING SPECIFICATIONS

➤ ASTM D4956 - 09 - Type IX

Presently there are no government specifications for this product.

Very High Intensity
Reflective Sheeting



➤ ASTM D4956 - 09 - Type XI

Presently there are no government specifications for this product.

Very High Intensity
Microprismatic Cube
Reflective Sheeting



3. PLYWOOD SUBSTRATE - FABRICATION

Fabrication of all plywood sign blanks will be accomplished in uniform and workmanlike manner. All possible fabrication, including cutting, drilling of holes and edge routing should be completed prior to application of prime and finishing paint coats, sign facing and/or cut-out letters.

➤ Cleaning

Prior to applying the sign facing or painting, the surface of the sign blank will be buffed lightly and wiped clean with lint free cloth to remove any trace of grease, wax or dirt.

➤ Edge Treatment

The edge of the plywood sign blank will receive a waterproof and weatherproof edge treatment.

➤ Application of Sheeting

Application of sheeting to conform to instructions issued by the sheeting supplier. Sign sheeting 120 cm or less on the longest side will not contain any splicing. Sign sheeting greater than 120 cm will be allowed one vertical lap splice.

➤ Legend Screened

Unless sheeting suppliers' specifications state otherwise, all signs utilizing the reverse screening method will have one coat of clear coat applied to the front side of the finished sign after the reflective sheeting has been placed on the plywood blank

Section:

SIGNS

Subject:

MANUFACTURING SPECIFICATIONS

➤ Cut-out Letters

All cut-out letters, digits and symbols will be in one piece and free of joints, splices and patches.

➤ Clear Coat

Unless sheeting suppliers' specifications state otherwise, clear top coat will be applied as an edge seal on all legends, border and sign edges.

4. ALUMINUM SUBSTRATE - FABRICATION

Fabrication of all metal sign blanks will be accomplished in a uniform and workmanlike manner. All fabrication including shearing, cutting and punching of holes will be completed prior to metal degreasing and application of materials. Sign blanks, will be cut to size and shape and free of buckles, warps, dents, cockles, burrs and defects. The surface of all sign blanks will be flat. The edges of the sign blank will be smooth and free of sharp projections.

➤ Cleaning

Aluminum blanks will be degreased and etched, including all necessary rinse operations in accordance with the sign facing manufacturer's specifications.

➤ Sign Facing

Application of the sheeting to conform to instructions issued by the supplier. Sign sheeting 120 cm or less on the longest side will not contain any splicing. Sign sheeting greater than 120 cm will be allowed one vertical lap splice.

➤ Legend Screened

Unless sheeting suppliers' specifications state otherwise, all signs utilizing the reverse screening method will have one coat of clear coat applied to the front side of the finished sign after the reflective sheeting has been placed on the metal blank.

➤ Cut -Out Letters

All cut-out letters, digits and symbols will be in one piece and will free of joints, splices and patches.

➤ Clear Coat

Unless sheeting suppliers' specifications state otherwise, clear topcoat will be applied as an edge seal on all legend, border and sign edges.

Date

2009-08-25

Page

3 of 4

Section:

SIGNS

Subject:

MANUFACTURING SPECIFICATIONS

5. Sign Specifications

Spec	Materials	Background	Level	Legend	Level
140	1.27 cm medium plywood	Reflectorized	2	Non-reflective (black)	
145	1.27 cm medium plywood	Reflectorized	2	Screened	
146	1.27 cm medium plywood	Reflectorized	1	Screened	
155	1.90 cm G1S plywood	Reflectorized	2	Reflectorized	
156	1.90 cm G1S plywood	Reflectorized	1	Reflectorized	
185	1.27 cm medium plywood	Reflectorized	DG	Screened	
210	Aluminum flat type	Reflectorized	2	Screened	
240	Aluminum flat type	Reflectorized	1	Screened	
245A	Aluminum flat type	Reflectorized	DG	Reflectorized	DG
245S	Aluminum flat type	Reflectorized	DG	Screened	
246A	Aluminum flat type	Reflectorized	FDG	Reflectorized	FDG
246S	Aluminum flat type	Reflectorized	FDG	Screened	
275	Aluminum flat type	Reflectorized	2	Reflectorized	2
276	Aluminum flat type	Reflectorized	1	Reflectorized	1
280	Aluminum flat type	Reflectorized	2	Screened	
281	Aluminum flat type	Reflectorized	1	Screened	
335	Aluminum flat type	Reflectorized	DG	Reflectorized	
310	Aluminum flat type	Reflectorized outer edge	2	Fluorescent vinyl centre	
340	Aluminum handle - 30 cm				
345	Aluminum handle - 150 cm				
580	Decal	Vinyl Film		Screened	
620	Decal	Reflectorized	2	Reflectorized	2
1000	Roll-up flexible signs, impact resistant and UV stabilized	Reflectorized	2	Screened	
1050	Roll-up flexible signs, impact resistant and UV stabilized	Reflectorized	1	Screened	

**TRAFFIC CONTROL DEVICES
MANUAL FOR WORK ZONES**

Section:
**CHANNELIZATION &
DELINEATION DEVICES**

Subject:
BARRICADES

APPLICATION

The primary function of barricades is to delineate a work area in or near the travelled portion of a roadway and to block off a portion or all of a lane or roadway where closures become a necessity. Barricades will not be used to channelize traffic.

STANDARD BARRICADE

The Standard Barricade is a portable device having three panels with reflective orange and black stripes. Each barricade panel must be 24 cm wide and 240 cm long. The orange and black stripes must be at least 15 cm wide. Barricades with stripes that begin at the upper right side and slope downward to the lower left side are to be designated as "right" barricades (CS-12R).



Barricades with stripes that begin at the upper left side and slope downward to the lower right side are to be designated as "left" barricades (CS-12L).



Markings for the top barricade panels will slope downward at an angle of 45 degrees in the direction traffic is to take.

The top rail of the barricade may be replaced with a CS-27 rail signifying to keep left or right.



Regulatory or warning traffic signs may be affixed to barricades to provide additional information to the motorist regarding the road closure.

A typical plan of the Standard Barricade is shown on the next page.

Section:
**CHANNELIZATION &
DELINEATION DEVICES**

Subject:
BARRICADES

STANDARD BARRICADE

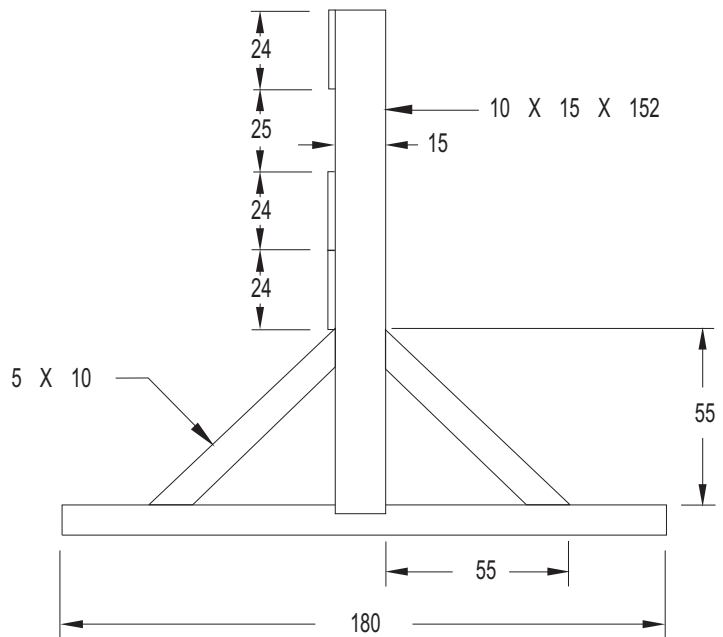
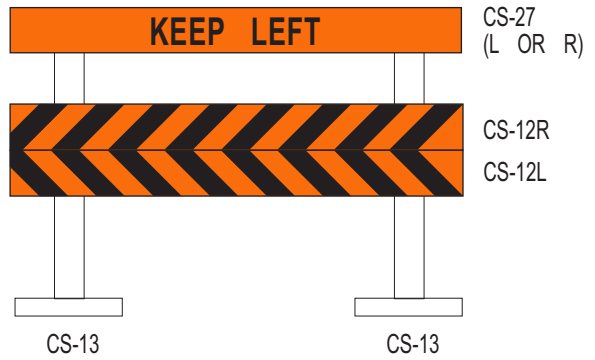
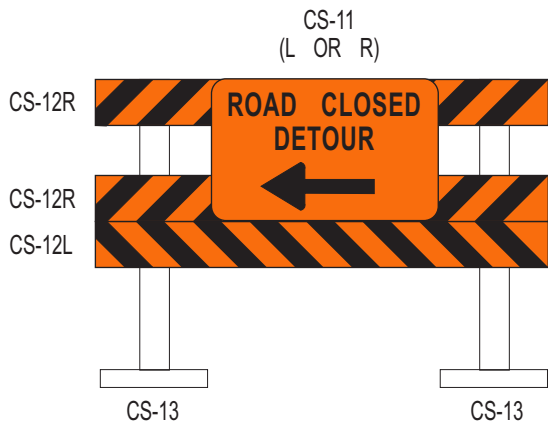

ALL DIMENSIONS IN CENTIMETRES

CS-13

Section:**CHANNELIZATION &
DELINEATION DEVICES****Subject:****BARRICADES****PORTABLE BARRICADE**

The Portable Barricade is light and easy to handle, store and transport. The intent is to use this type of barricade for short term road closures such as a washout. The barricade consists of one rail with reflective orange and black stripes.

The stability of portable barricades may be enhanced with the use of sandbags provided they are placed on or close to the barricade base.

PORTABLE BARRICADE**Date**

2009-08-05

Page

3 of 3

TRAFFIC CONTROL DEVICES MANUAL FOR WORK ZONES

Section:
**CHANNELIZATION &
DELINEATION DEVICES**

Subject:
DELINEATORS

APPLICATION

Delineation devices are used to warn and alert motorists of hazards created by work activities in or near the travelled way and to guide and direct motorists safely past the hazards.

Devices used for delineation (or channelization) should provide a smooth and gradual transition in moving traffic from one lane to another, onto a bypass or detour, or reduce the width of travelled way. They may also be used to separate traffic from the work area, pavement drop-offs, or storage areas.

Delineating cones, markers or flexible drums used for transition taper alignments may get out of their normal alignment and spacing due to being struck by vehicles or moved by the wind and suction created by fast-moving trucks, construction, maintenance, or utility activities. It is therefore necessary for the Traffic Accommodation Supervisor to patrol the delineation at frequent intervals to ensure it is functioning properly.

Since the delineators can be easily knocked down, displaced or blown over, some devices need extra weight to keep them in place. Sand bags or plastic collars may be used but solid materials such as rock, concrete, etc., are not acceptable for this purpose. Extra weights should be placed at the base of devices to provide maximum stability and to avoid the weights becoming projectiles in the event of a collision.

TYPES OF DELINEATORS

Delineation is achieved by proper placement of traffic cones, tubular markers, flexible drums, or other similar devices. Delineation devices used during the hours of darkness will be reflectorized or illuminated to show the same colour and shape by night as by day.

TRAFFIC CONES

Traffic cones are lightweight, flexible delineation devices.

Traffic cones are used primarily for daylight operations but may be used at night if equipped with white reflectorized bands.

Section:
CHANNELIZATION &
DELINEATION DEVICES

Subject:
DELINEATORS

When traffic cones are used, the size required is dependant on traffic speed:

> 50 km/hr = minimum height of 70 cm

< 50 km/hr = minimum height of 45 cm

Night time = minimum height of 70 cm

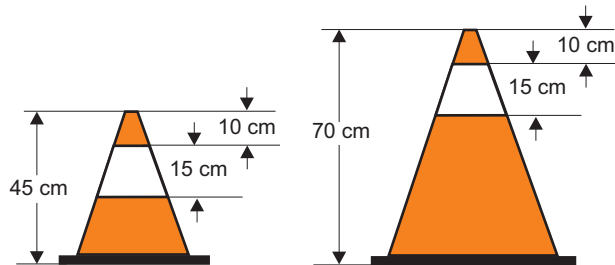

TRAFFIC CONES

FLEXIBLE DRUMS

Flexible drums are generally used in work zones where delineation devices will remain in place for extended periods of time.

For night time use, flexible drums are reflectorized by application of alternating horizontal bands of orange and white reflectorized sheeting. There must be a minimum of two white bands and three orange bands, being 10 cm deep.

TOP VIEW



SIDE VIEW

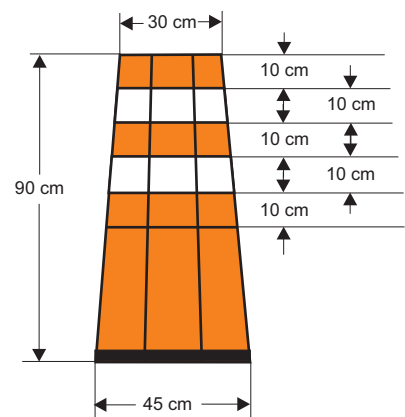

FLEXIBLE DRUMS

Section:
**CHANNELIZATION &
 DELINEATION DEVICES**

Subject:
DELINEATORS

TUBULAR MARKERS (DELINEATION POST)

Tubular markers are similar to traffic cones in that they are lightweight and easy to install and remove.

They are particularly suited to delineating traffic lanes or separating two-way traffic for short duration work.

These orange markers must have at least two circular bands of white retroreflective sheeting.

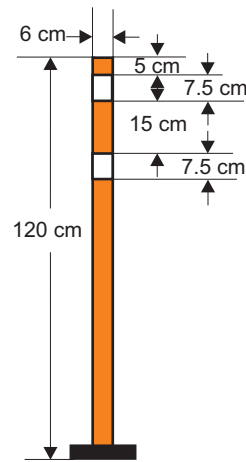

TUBULAR MARKERS

TAPERS

The single most important element within the system of traffic control devices commonly used in work zones is the transition taper for full lane closure or for other reductions in the pavement width. An inadequate taper will almost always produce undesirable traffic operations with resulting congestion and possible collisions through the area.

The taper length will comply with the following minimum requirements:

MAXIMUM SPEED (km/hr)	TAPER LENGTH (m)
30 - <60	40 - 74
60 - 100	75 - 150

Section:

CHANNELIZATION &
DELINEATION DEVICES

Subject:

DELINEATORS

SPACING OF DELINEATORS

The centre to centre distance between delineators on the taper will be as follows:

MAXIMUM SPEED (km/hr)	MAXIMUM CENTRE TO CENTRE SPACING (m)
30 - <60	5 - 9
60 - 100	10 - 15

The centre to centre distance between delineators adjacent to the direction of travel will be as follows:

MAXIMUM SPEED (km/hr)	MAXIMUM CENTRE TO CENTRE SPACING (m)
30 - <60	30 - 89
60 - 100	90 - 150

PAVEMENT EDGE DROP-OFF

At certain speeds, particularly during periods of darkness, a pavement edge drop-off becomes a potential hazard to the motorist. Every reasonable effort must be made to minimize the amount of pavement edge drop-off that is present when the travelled way is open to traffic. The length of pavement edge drop-off should be minimized by:

- scheduling the paving of adjacent lanes so that there is no pavement drop-off along the centre line of a road at the end of the day's operation; and
- scheduling the construction of shoulder base or shoulder fillets, concurrently with the paving operations.

Section:**CHANNELIZATION &
DELINEATION DEVICES****Subject:****DELINEATORS**

However, where a pavement edge drop-off is present and the travelled way is open to traffic, the following devices and practices will be utilized:

- pavement drop-off signs will be installed at not more than 3 km intervals;
- any pavement drop-off at the edge of the travelled way will be delineated when the drop-off exceeds 60 mm; and
- any pavement drop-off at centre line will be delineated when the drop-off exceeds 60 mm. Delineators will be weighed down or securely fastened to the pavement so they will not be blown over by the wind or passing vehicles.

Date

2009-08-25

Page

5 of 5

TRAFFIC CONTROL DEVICES
MANUAL FOR WORK ZONES

Section:
**CHANNELIZATION &
DELINEATION DEVICES**

Subject:
BARRIERS

APPLICATION

Barriers protect work areas and drivers by preventing or reducing vehicle penetration into the work areas and by redirecting errant vehicles in a controlled manner. The effectiveness of the barrier system depends on its correct placement and on the size, speed, and angle of approach of the errant vehicle.

Unless specified, barriers are normally placed parallel or near parallel to approaching traffic. They are solid in design and are installed in a continuous manner.

Where required, concrete barriers are most commonly used in long duration work zones to:

- Protect workers
- Separate motorists from potentially hazardous objects and areas in work zones
- Separate opposing lanes of traffic where barricades or other delineation devices are not considered adequate
- Reinforce other channelizing devices in lane closure tapers or other areas where traffic cannot be allowed to enter

PRE-CAST
CONCRETE BARRIERS

Two typical pre-cast concrete barriers are shown on the next page.

REFLECTORIZATION

Reflective material arranged at the top of the barrier can be very effective in increasing the visibility of barriers in work zones. ReflectORIZED material should be placed as close to the top of the barriers as possible to ensure that motorists can see it. Reflectors that are fastened to the top of barriers are available. The lines of sight should not be obstructed by any object between the reflectORIZATION and motorists.

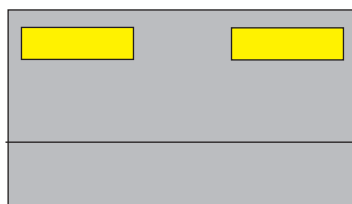

(optional)

Section: CHANNELIZATION & DELINEATION DEVICES

Subject: BARRIERS

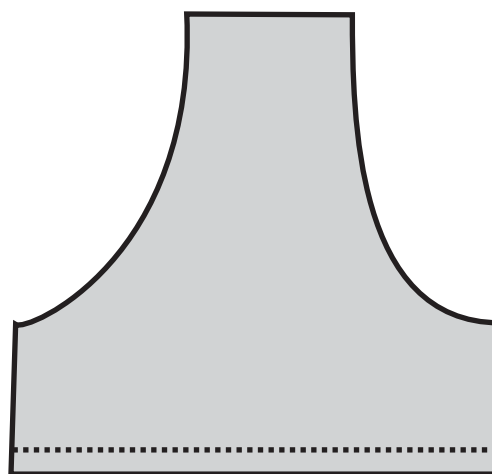
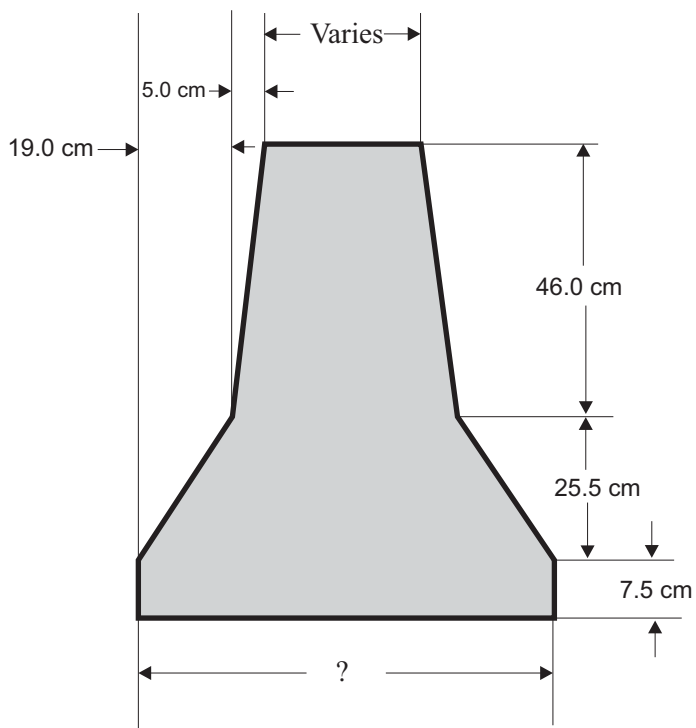
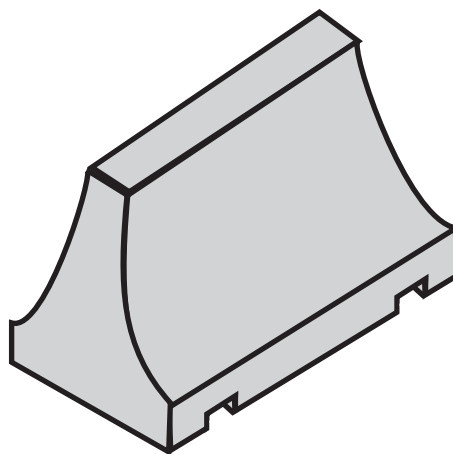
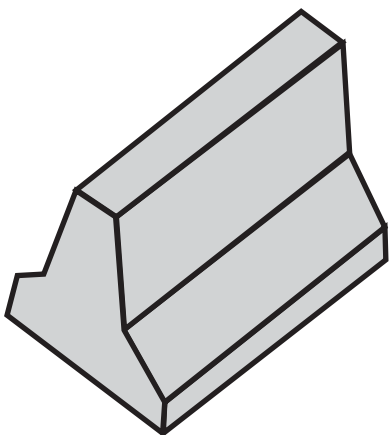

PRE-CAST
CONCRETE BARRIERS

TRAFFIC CONTROL DEVICES
MANUAL FOR WORK ZONES

Section:

MARKINGS

Subject:

PAVEMENT MARKINGS

SUMMARY

Pavement markings consist of centrelines, shoulder lines, lane lines, intersection layouts and pavement signs. Temporary pavement markings should be used in combination with appropriate warning signs, delineators or other channelizing devices to clearly indicate the required vehicle path.

Pavement markings should be used where traffic is diverted from normal paths and where guidance by warning signs or delineation does not clearly indicate the required path.

When a surface detour or temporary roadway is constructed, all necessary pavement markings and other channelizing devices will be in place along its approaches to and throughout its length before being opened to traffic.

Pressure sensitive temporary marking tape should be applied on surfacing projects to delineate the centreline on each lift of a newly constructed pavement until the permanent markings can be applied. The temporary marking tape should be applied before the end of each work shift.

Pavement markings and channelization devices should be supplemented by raised reflective markers on a temporary roadway such as on a transition from a four lane to a two lane facility.

Pavement markings are often obliterated due to work zone activities. Whenever this occurs, temporary pavement markings should be applied until the permanent markings can be replaced. Conflicting pavement markings, which might inadvertently lead motorists from the intended path, will be obliterated immediately to prevent confusion.

Typical traffic accommodation plans for the various pavement marking activities are included in Typical Plans.

All painting material must comply with Ministry specifications.

TRAFFIC CONTROL DEVICES
MANUAL FOR WORK ZONES

Section:
FLAGGING

Subject:
FLAGGING

SUMMARY

Flagpersons play an important role in the high level of traffic safety expected through work zones on Saskatchewan highway projects. Flagpersons are responsible for directing traffic through work zones, protecting the workers from traffic dangers and addressing motorists' work zone concerns.

A critical examination should be made of each project to determine if flagging is necessary, and if so, what is the minimum level that can be used to coincide with job and safety needs.

Flagging is very effective and practical for all work zone situations. Flagging is more costly to implement than most other speed control methods due to the cost of labour.

Flagpersons are provided at work areas to stop traffic intermittently as necessitated by work progress or to maintain continuous traffic flow past a work area at reduced speeds to help protect the workers. For both of these functions flagpersons shall be clearly visible to approaching motorists for a distance sufficient to permit proper response by the motorist to the flagging instructions.

Because of their extremely exposed position with a high accident potential, alternate effective means of control should be used wherever possible.

RESPONSIBILITIES

The responsibilities of the flagperson are:

- To direct traffic safely through the work zone.
- To protect the motorist from work zone dangers.
- To protect the workers, including themselves, from traffic dangers.
- To address motorists' work zone concerns.

Section:

FLAGGING

Subject:

FLAGGING

QUALIFICATIONS FOR FLAGPERSONS

It is important that qualified personnel be selected and trained in the fundamentals of flagging before being assigned to a flagging task. Flagpersons shall be certified as a flagperson by the Ministry of Highways and Infrastructure or by the Heavy Construction Safety Association of Saskatchewan.

Flagpersons shall have the required copy of the flagperson's "Certificate of Training in Workzone Flagging" with them at the worksite, and be able to readily produce it upon request.

Flagpersons should possess the following minimum qualifications:

- Average intelligence and mentally alert.
- Good physical condition, including sight and hearing.
- Courteous but firm manner.
- Neat appearance.
- Sense of responsibility for safety of public and workers.
- Ability to communicate effectively.
- Pleasing personality.

FLAGPERSON'S APPAREL

For daylight flagging operations, the flagperson's apparel shall include:

- Approved footwear.
- Fluorescent orange or other high visibility colour hard hat.
- One of the following three clothing options:
 - All high-visibility coveralls shall meet CSA Z96-09, Class 3, Level 2, minimum Table 2B for background material.
 - All high-visibility safety vests shall meet CSA Z96-09, Class 2, Level 2, minimum Table 2A for background material or ANSI/ISEA 107-1999, Class 2, Level 2. High visibility clothing must also be worn with vests. (The colour should achieve the maximum contrast between the flagperson, the roadway and the work environment.) Acceptable colours shall include white, orange or fluorescent yellow/green.
 - All high-visibility safety bib style overalls shall meet CSA Z96-09, Class 2, Level 2, minimum Table 2A for background material. A high-

Section:**FLAGGING****Subject:****FLAGGING**

visibility safety vest meeting the above standards must also be worn with the bib style overalls.

- Ministry staff and consultants refer to the Ministry of Highways and Infrastructure Safety Manual, SM 1200-400.

For night flagging operations, in addition to the daylight requirements, the flagperson's apparel shall include:

- Reflective strips or bands on the headgear and reflective armllets.

FLAGPERSON'S TOOLS

Flagperson's tools shall include:

- STOP/SLOW paddle.
- Flashlight with semi transparent red/orange cone for flagging for night time.

Flagperson's tools should also include:

- Two way radio when visibility is restricted between flagpersons.
- Horn or whistle (optional item).
- Log book and pencil for recording traffic violations.
- Eye protection.
- Suitable outerwear for prevailing conditions (rainwear).

The signs and paddles shall be:

- Ministry approved.
- Reflective.
- Kept clean at all times.
- Replaced if face or legend is damaged.

FLAGGING STATION

Flagging stations shall be adequately protected and preceded by proper advance warning signs.

Flagpersons should stay 70 to 150 m from the work area or crew.

Flagpersons shall be visible for a minimum distance for 125 m by

Date

2009-08-25

Page

3 of 11

Section:
FLAGGING

Subject:
FLAGGING

the motorist. Flagpersons shall take a position so that the motorist’s vision of the flagperson is not impaired by curves, hills, parked vehicles, traffic control signs or delineators.

Flagpersons shall stand alone, and shall not mix with other workers.

During periods of darkness, the flagging station shall be illuminated by lights where reasonably practical.

**NUMBER OF
FLAGPERSONS**

At least one flagperson shall be utilized if traffic approaches from one direction only. If traffic approaches from both directions and the flagperson and the operator of any approaching vehicle would be clearly visible to one another.

At least two flagpersons shall be utilized if traffic approaches from both directions and the flagpersons and the operator of any approaching vehicle would not be clearly visible to one another.

On sections where the two flagpersons are not visible to one another, a third flagperson, or some other means of communication, such as two way radios, is required to relay instructions to the flagperson at either end.

**ONE WAY TRAFFIC
CONTROL**

Where traffic in both directions must use a single lane, provision should be made for alternate one way movement to pass through the restricted section.

Some means of co-ordinating movements at each end of the section must be incorporated so that delays are not excessive at either end. Control points at each end of the restricted section should be chosen so as to permit easy passing of opposing line of vehicles.

Alternate one way traffic movement may be effected by the following means:

- Flagperson control.
- Pilot vehicle.

FLAGPERSON CONTROL

Where a one-lane two-way temporary traffic control zone is short enough to allow visibility from one end to the other, traffic may be controlled by either a single flagperson or by a flagperson at each end of the section. When a single flagperson is used, the flagperson should be stationed on the shoulder opposite the obstruction or work space, or in a position where good visibility and traffic control can be maintained at all times. When good visibility and traffic control cannot be maintained by one flagperson station, traffic may

Section:**FLAGGING****Subject:****FLAGGING**

be controlled by a flagperson at each end of the section. One flagperson shall be designated as the Chief flagperson for purposes of co-ordinating traffic movement. They should be able to communicate with signals or by two way radio.

PILOT VEHICLE

The use of a pilot vehicle for traffic control can be most effective where work is being performed over a long section of highway. The pilot vehicle is used to guide a train of vehicles through the restricted section or detour. Its operation must be co-ordinated with flagging operations at each end of the one lane section.

Sufficient turnaround room should be provided at these points. Provision should be made for identification of the last vehicle in the train.

The pilot vehicle shall:

- Co-ordinate the activities with flagging operations at each end of the one lane section.
- Escort the line of traffic through work area.
- Move over to the right/left shoulder of the road, depending on the direction of work, to a minimum of 35 m in advance of the flagperson station on the opposing lane and stop.
- Not travel faster than 60 km per hour.

The desirable maximum waiting time when stopping and holding motorists in a line at a work area is six to ten minutes.

Pilot vehicles should be vehicles which are easily maneuvered and shall be equipped with the following items:

- A CS-32 sign prominently displayed at the rear (PILOT VEHICLE FOLLOW ME).
- A rotating or flashing amber light mounted on the roof.
- Red flags mounted on each side at conspicuous locations.
- See TYPICAL PLAN FOR PILOT VEHICLE OPERATION - 1 OR 2 LANES UNDER REPAIR FOR THE USE WITH ALL SIGN PLANS on next page.

Date

2009-08-25

Page

5 of 11

Section:

FLAGGING

Subject:

PILOT VEHICLE OPERATION
FOR 1 LANE OR 2 LANE UNDER REPAIR
FOR THE USE WITH ALL SIGN PLANS

* CODE	REGULAR OR WZ SPEED LIMIT	0 - <60 km/h (m)	60 - 100 km/h (m)
1	LANE CLOSURE TAPER LENGTH	40 - 74	75 - 150
2	DISTANCE BETWEEN MARKERS	5 - 9	10 - 15
3	DISTANCE BETWEEN SIGNS	30 - 89	90 - 150

NOTES:

- PILOT VEHICLE OPERATOR WOULD ESCORT LINE OF TRAFFIC THROUGH WORK AREA, MOVE OVER TO THE RIGHT/LEFT SHOULDER OF THE ROAD, DEPENDING ON THE DIRECTION OF WORK, TO A MINIMUM OF 35 METRES IN ADVANCE OF THE FLAG PERSON STATION ON THE OPPOSING LANE AND STOP.
- THE PILOT VEHICLE OPERATOR WOULD WAVE THE ESCORTED TRAFFIC PAST THEIR POSITION.
- WHEN THE TRAFFIC HAD CLEARED AND IT WAS SAFE TO DO SO, TURN AROUND ON THE ROAD SURFACE IN FRONT OF THE FLAG PERSON AND PICK UP THAT LANE OF TRAFFIC.
- CORRESPONDING TRAFFIC CONTROL DEVICES WILL BE ERECTED FOR TRAFFIC TRAVELLING IN THE OPPOSITE DIRECTION.
- THE FOLLOWING SIGNS MAY BE USED IN PLACE OF THE ROUGH ROAD SIGN:

BE PREPARED TO STOP	CS-5
FRESH OIL	CS-7
LOOSE GRAVEL	CS-9
LOOSE STONES	CS-28
PAVEMENT ENDS	WD-A25
- ONE FLAGPERSON IS REQUIRED FOR ALL ACTIVITIES IN WHICH ONE LANE IS BEING AFFECTED BY CONSTRUCTION. ADDITIONAL FLAGPERSONS ARE OPTIONAL. FOR WHEN TO USE ADDITIONAL FLAGPERSONS REFER TO TCDM 701.

TWO FLAGPERSONS ARE REQUIRED FOR ALL ACTIVITIES IN WHICH BOTH LANES ARE BEING AFFECTED BY CONSTRUCTION

FLAGPERSON(S) SHALL BE VISIBLE TO THE TO THE MOTORISTS APPROACHING THE WORK ZONE FOR A MINIMUM OF 125 METRES.
- THE REGULATORY SPEED SIGN USED AT THE END OF THE WORK ZONE MUST MATCH THE SPEED LIMIT THAT WAS POSTED PREVIOUS TO THE WORK ZONE.

TYPICAL PLAN

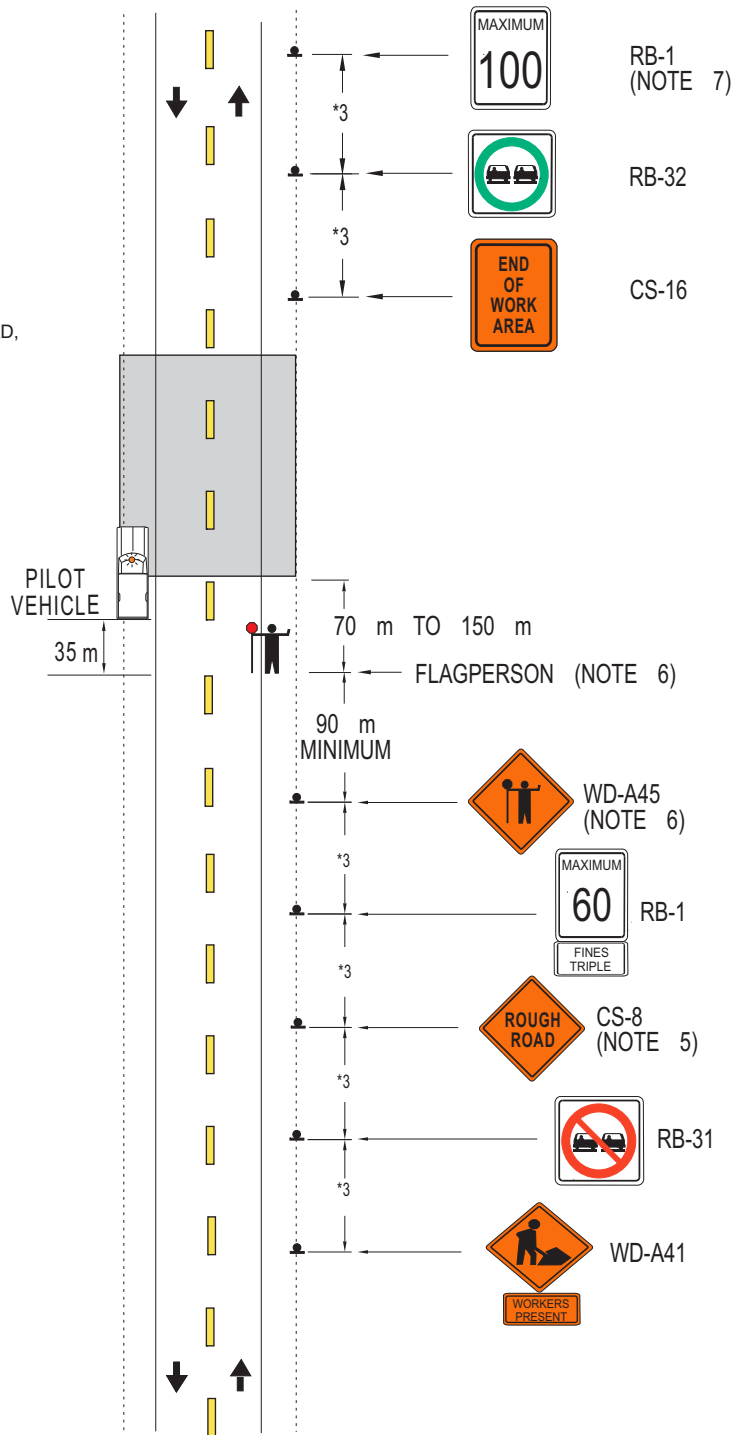

Section:

FLAGGING

Subject:

FLAGGING

FLAGGING PROCEDURE

- Careless Drivers

Flagpersons must bear in mind that when handling many vehicles and drivers there always exists the chance that erratic, unpredictable, inattentive or careless drivers will appear and become a hazard. In these cases, the flagperson must be alert and give warning of impending danger to the workers and the public. Flagpersons must determine an escape route prior to the commencement of flagging.
- Uniform Flagging

Uniform flagging procedures are an important part of traffic operations. With uniform and consistent procedures and signals, the motorist will more readily comply and proceed through the work zone in a safe manner.
- Face Traffic

The flagperson shall face traffic when signalling motorists to stop, slow down or proceed.
- Position of Flagperson

The flagpersons shall stand at a location to be visible to the motorist for a minimum distance of 125 m.

The flagperson should stand from 70 m to 150 m from the beginning of the work area. This position is illustrated on the last page of this document.
- Position of Vehicle used by the Flagperson

All vehicles that are used by flagpersons shall be parked a minimum of 15 m from the flagperson station. The vehicle will be positioned between the flagperson and the work crew. Where practical, this vehicle should be parked in the ditch and if this is not possible, as far to the right as possible onto the shoulder.
- To Stop Traffic

The flagperson shall stand on the shoulder of the road in a stationary position facing traffic. The STOP paddle shall be extended over the traffic lane and be held in a vertical position at arms length. The free arm shall be raised with the palm of the hand towards approaching traffic. The flagperson shall direct the first vehicle to the shoulder of the road with the free hand, to a point a minimum of 15 m in front of the flagpersons position. Once the vehicle has come to a full stop and when safe, the flagperson will move into the traffic lane, as far as necessary without crossing centre line. This position will ensure that the flagperson can see and be seen by the next approaching vehicle. The flagperson shall ensure the STOP paddle is held so it is visible to the stopped traffic, as well as approaching traffic.

Date

2009-08-25

Page

7 of 11

Section:**FLAGGING****Subject:****FLAGGING**

The flagperson would occasionally glance over their shoulder to ensure that traffic from the opposing lane was not entering their lane. As more vehicles approach, the flagperson would hold his free arm up and with the palm of the hand showing, direct the vehicles in behind the line of traffic already stopped.

- Traffic To Proceed

When releasing traffic, the flagperson returns to the shoulder position and turns the STOP/SLOW paddle to the Slow position. The flagperson will face the traffic, and with the SLOW paddle held in a vertical position, motion traffic ahead with the free arm.

- To Slow Traffic

The flagperson shall face traffic and hold the SLOW sign in a vertical position at arms length. For added emphasis, the flagperson may slowly raise and lower the free hand with the palm down.

- Flagperson Signals

For illustration of flagperson signals, refer to page 10 of this section.

- Relief Flagperson

Flagpersons should be relieved periodically, where possible every two hours, during the course of work; rest breaks are important to maintain effective flagging operations. A person relieving a flagperson must wear the proper apparel required for flagging operations.

- Emergency Vehicles & Crews

Flagpersons shall make every effort to accommodate travel of emergency vehicles and workers through the work zone.

- Flagpersons Shall Not

Wave the paddle to stop or move traffic.

Leave the flagging station unattended or mix with the crew. The crew safety and that of the motorist depends on being easily seen at a safe distance from other workers.

Leave the STOP/SLOW paddle standing on a post, acting as a STOP or SLOW sign.

Leave a vehicle or other obstruction near the flagging station as this may cause a distraction and prevent a quick exit in an emergency.

Wear headphones while on duty.

Sit down at the flagging station.

Section:**FLAGGING****Subject:****FLAGGING**

- **Flagperson Signs** All signs indicating that a flagperson is on duty shall be removed or covered when there is no flagperson on duty.
- **Night Flagging** When flagging at night the flagperson shall slowly wave, above the head, in a semicircular arc, a flashlight with a red/orange wand to attract the drivers attention and to illuminate the STOP/SLOW paddle.

Date

2009-08-25

Page

9 of 11

Section:

FLAGGING

Subject:

FLAGGING



FLAGPERSON SIGNALS

1. To Stop Traffic - The flagperson will stand outside the traffic lanes, and in a stationary position, facing traffic, extend the STOP sign over the traffic lane. Hold the STOP sign in a vertical position at arm's length. For greater emphasis, the free arm may be raised with the palm toward approaching traffic.



2. When it is Safe for Traffic to Proceed - The flagperson shall face the traffic, and with the SLOW sign held in a vertical position, motion traffic ahead with the free arm.



3. Where it is Desired to Alert or Slow Traffic - The flagperson shall face traffic and hold the SLOW sign in a vertical position at arm's length. For added emphasis, the flagperson may slowly raise and lower the free hand with the palm down.

Section:

FLAGGING

Subject:

FLAGGING

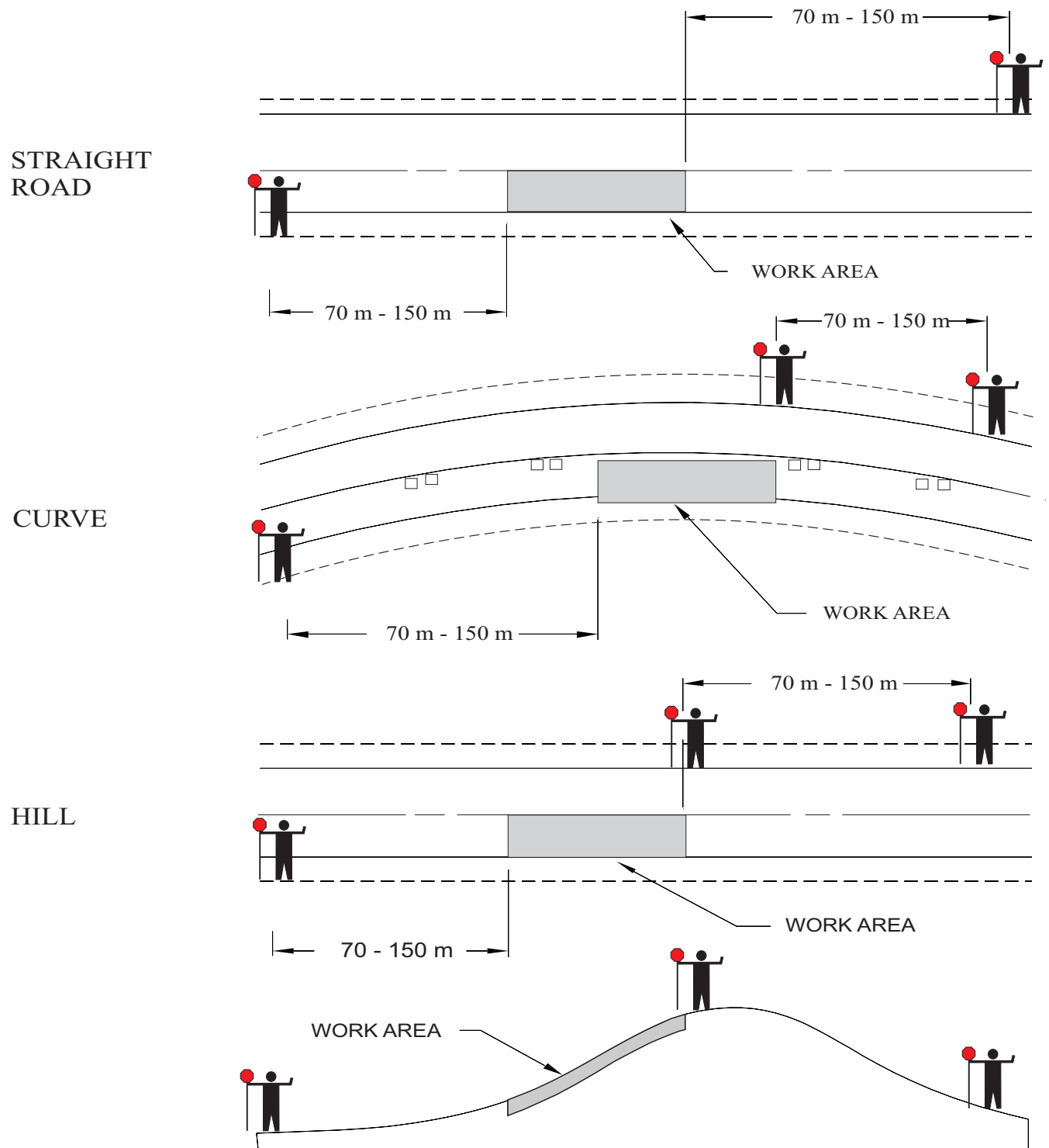

NOTE:
ON CURVES AND HILLS, THREE FLAGPERSONS OR SOME
OTHER MEANS OF COMMUNICATION ARE REQUIRED.

Date

2009-08-25

Page

11 of 11

TRAFFIC CONTROL DEVICES
MANUAL FOR WORK ZONES

Section:

FLAGGING

Subject:

TRAFFIC OBSERVER

SUMMARY

Traffic observers play an important role in maintaining employee safety in highway work zones. Traffic observers are responsible for protecting the workers from traffic dangers. Traffic observers are essentially used on fast moving projects where a flagperson isn't required but worker safety may be compromised by not being able to observe oncoming traffic. Traffic observers are not flagpersons, their sole responsibility is the safety of other workers at the job site.

QUALIFICATIONS

Traffic observers will have a valid flagperson certification.

RESPONSIBILITIES

The responsibilities of the traffic observer is to:

- Protect the workers, including themselves, from traffic dangers; and,
- Observe oncoming traffic and to warn the other workers if oncoming traffic appears to be a threat.

PROCEDURES

- The work crew will clearly determine who is the traffic observer before work begins.
- The work crew will determine the means by which the traffic observer will warn the work crew of pending danger and the means of escape. If an adequate means of escape cannot be achieved, then flagging should be considered. The decision to flag should be made prior to commencement of work and not after a situation has developed.
- The traffic observer will be located in a position that has a clear view of oncoming traffic.
- The sole responsibility of the traffic observer is to watch the traffic and warn the highway workers if oncoming traffic appears to be a threat.
- Work will not start until the traffic observer gives the "All Clear".
- If the work crew is moved off the road surface because of oncoming traffic, work will not resume until directed to do so by the traffic observer.

TRAFFIC CONTROL DEVICES MANUAL FOR WORK ZONES

Section:

LIGHTING DEVICES

Subject:

LIGHTING DEVICES

SUMMARY

Work zone activities often create conditions on the travelled way that are hazardous particularly at night when the ability of motorists to see is sharply reduced from daytime conditions. It is often desirable and necessary to supplement the reflectorized signs, barriers and delineating devices with lighting devices that are described below.

WARNING LIGHTS

- Description

Warning lights are portable, lens directed, enclosed lights. The colour of light emitted will be amber. They may be used in either a steady burn or flashing mode. Warning lights will be in accordance with current Institute of Transportation Engineers Purchase Specifications for Flashing and Steady Burn Warning Lights, with regard to colour, lens size, flash rate, and minimum on time.

- Mounting Height

Warning lights will have a minimum mounting height of 1.0 m to the bottom of the lens.

- Low Intensity

Low Intensity Flashing Warning lights are most commonly mounted on barricades, drums, or advance warning signs, and are intended to continually warn motorists that they are approaching an obstacle or other potential conflict.

- High Intensity

High Intensity Flashing Warning lights are normally mounted on advance warning signs or on independent supports. High Intensity Warning lights should be used to warn motorists of an extremely hazardous site condition within the work area. As these lights are effective in daylight as well as dark, they are designed to operate 24 hours per day.

- Steady Burn

Steady Burn lights may be used to delineate the edge of the travelled way on detour curves, lane changes, lane closures and other similar conditions.

Section:

LIGHTING DEVICES

Subject:

LIGHTING DEVICES

FLASHING LIGHT BOARDS

Flashing light boards are internally illuminated sign panels or a matrix of lights capable of either flashing or sequential display. Flashing light boards are very effective in:

1. providing additional advance warning;
2. providing directional information; and
3. encouraging motorists to leave the closed lane.

• Use of Flashing Light Boards

Flashing light boards will be used in the following manner on:

1. Two lane highway.

- Right Flashing Arrow or Right Sequential Chevron
 - for passing to the right of the work area where sufficient shoulder width is available; and
 - for local roadside detours to the right.
- Left Flashing Arrow or Left Sequential Chevron
 - for local roadside detours to the left.
- Caution Mode
 - shoulder closure;
 - lane closure;
 - stop condition; and
 - caution condition.
- For moving pavement marking operations, the left or right flashing arrow mode may be used, but only in conjunction with the When Safe Pass As Shown sign (CS44).

2. Four lane highway

- Right Flashing Arrow or Right Sequential Chevron
 - for passing to the right of the work area; and
 - for local roadside detours to the right.
- Left Flashing Arrow or Left Sequential Chevron
 - for passing to the left of the work area; and
 - for local roadside detours to the left.
- Caution Mode
 - for stop condition; and
 - caution condition.

Section:**LIGHTING DEVICES****Subject:****LIGHTING DEVICES**

- Placement of Flashing Light Boards

Placement of flashing light boards should be varied as needed to achieve the desired recognition distances. Also, care must be taken in the placement to avoid causing motorist confusion in the vicinity of ramps, median crossovers and side road intersections.

For stationary lane closures, the flashing light boards should be placed on the shoulder. When available, they should be placed at the beginning of the taper and/or where there are narrow shoulders and/or in the closed lane behind the channelizing devices on the same side of the lane closure. Placement at the start of the taper is preferred to placement in the middle of the taper.

In diversions where flashing light board need has been determined, the arrow panel should be placed behind the barricades closing the roadway.

For moving operations where a lane is closed, it is preferable that the flashing light board be placed at the rear of the activity in the closed lane on a vehicle separate from the work activity itself. The flashing light board should always remain upstream of the work activity where adequate recognition distance is available. The vehicle carrying the flashing light board should also be equipped with appropriate signing and/or lighting.

Flashing light boards may be used for moving pavement marking operations without a lane closure but only in conjunction with the When Safe Pass As Shown sign (CS44).

Generally, arrow panels should not be used for shoulder or roadside work activities nor should they be used on two lane highways because the panels can cause unnecessary lane changing.

SPECIFICATIONS FOR FLASHING LIGHT BOARDS

Flashing light boards should meet the specifications in the table below. Minimum legibility distances for various traffic conditions are based on the decision-sight distance concept. Minimum legibility distances are those at which the light board message can be comprehended by a motorist on a sunny day or clear night.

Flashing Light Board Specifications

Type	Minimum Size (cm)	Minimum Number of Lamps	Minimum Legibility Distance (m)
A	60 x 120	12	800
B	75 x 150	13	1200
C	120 x 240	15	1600

Date

2009-08-25

Page

3 of 6

Section:

LIGHTING DEVICES

Subject:

LIGHTING DEVICES

Type A light boards are appropriate for use on urban streets. Type B and C light boards are appropriate for work zone activities on two lane and four lane highways.

Light boards will be rectangular, of solid construction and finished with non-reflective flat black. Boards will be mounted on a vehicle, trailer or other suitable support. Vehicle mounted boards will be provided with remote controls. Minimum mounting height should be two metres above roadway to the bottom of the board, except on vehicle mounted boards which should be as high as practicable.

Light boards should have the capability of the following mode selections:

1. left or right flashing or sequential arrows;
2. left or right sequential chevrons;
3. double flashing arrows; and
4. caution.

The caution mode consists of four or more lamps, arranged in a pattern which will not indicate a direction.

Light boards will be capable of a minimum of 50 percent dimming from the rated lamp voltage. Light board lamps will be operated in high intensity mode during daylight hours and in low intensity mode during night-time hours. Lamp flashing rate will not be less than 25 nor more than 40 flashes per minute.

Minimum lamp "on time" will be 50 percent for the flashing arrow and 25 percent for the sequential chevron.

Light board lamps or lenses will be recess mounted or, alternately equipped with an upper hood of not less than 180°, and the colour of light emitted will be yellow.

SELF-PROPELLED EQUIPMENT

All self-propelled non-steel tracked equipment, including pickup trucks and larger, engaged in the maintenance or construction of highways will be equipped with a rotating or flashing amber light. The rotating or flashing amber light will be mounted such that it is clearly visible in all directions to the highway user.

Section:**LIGHTING DEVICES****Subject:****LIGHTING DEVICES****TRAFFIC SIGNALS**

A traffic control signal (traffic signal) is a device used for the control of vehicular and pedestrian traffic. Traffic signals alternately direct traffic to stop and go.

Traffic signals are either pre-timed or traffic-actuated devices. Under pre-timed control, duration of red, green and yellow intervals are predetermined. Under traffic-actuated control, the duration of green intervals vary according to traffic demands.

- Height of Signal Faces

The bottom of a signal face housing will be installed as follows:

1. If the signals are not mounted over the roadway, the height shall be 2.5 m to 4.5 m above the centreline top of pavement.
2. If the signals are suspended over a roadway they shall be 4.5 m to 5.8 m above the centreline top of pavement.

Within the above limits, optimum visibility and adequate clearance should be the guiding considerations in deciding signal height.

- Transverse Location of Signal Supports

Signal supports and controller cabinets should be placed as far as practicable from the edge of the roadway, but should not be less than 1.0 m from the edge of a shoulder.

MISCELLANEOUS DEVICES

Other miscellaneous lighting devices such as flares, floodlights, flashlights, lanterns, etc., may be used as required to supplement the signs and other devices in this Manual.

Section: STATUTES AND REGULATIONS

Subject: FLASHING LIGHT BOARDS OPERATING MODES

1. Flashing Arrow



2. Sequential Flashing Arrow



3. Sequential Flashing Chevron



4. Caution

Flashing Bar



Flashing Corners



TRAFFIC CONTROL DEVICES
MANUAL FOR WORK ZONES

Section:

ADDITIONAL DEVICES

Subject:

INTRODUCTION

INTRODUCTION

Standard work zone devices contained elsewhere in this manual may not always be effective in maintaining an appropriate level of traffic accommodation through work zones. Additional tools used in conjunction with standard devices can emphasize to the motorist the need for additional caution.

The traffic control devices listed in this section have been proven effective either by the Ministry by other highway jurisdictions.

The choice of device used will depend upon its effectiveness for the particular situation and the practicality of implementing. It is left to the judgement of the individual using these devices to decide which would be best for a given project.

The devices are listed in no particular order.

TRAFFIC CONTROL DEVICES
MANUAL FOR WORK ZONES

Section:

ADDITIONAL DEVICES

Subject:

ELECTRONIC VARIABLE
MESSAGE BOARDS

ELECTRONIC VARIABLE MESSAGE BOARDS (EVMB)

EVMB are message boards that can be used to provide essential information for drivers. EVMB are used in work zones predominantly to display a brief statement that informs motorists of road work or road obstruction, the location of the obstruction, and the action that motorists are expected to take.

EVMB can be used in conjunction with a radar unit. The radar sends signals directed at the oncoming traffic. The frequencies of the rebounding signals give the unit controller information about how fast vehicles are travelling. The EVMB will display the speed that a vehicle is travelling as it approaches the sign. The unit controller can be programmed to display a message (i.e. "YOU ARE SPEEDING/SLOW DOWN") when vehicles are travelling above a threshold speed. Information on Radar Feedback signs can be found in TCDMWZ 908.

EVMB are practical for a wide range of work zone situations: stationary, fast moving and for long and short duration because they are easy to implement and move. They can also be very effective at night and in inclement weather. Studies have shown EVMB to be an effective addition to work zones when the message is simple and concise, kept current and only displays verified information.

Types of EVMB

The most common type of EVMB is light-emitting, which usually have light emitting diode bulbs attached in a matrix on the viewing surface. Typically EVMB have a "full matrix" display, which allows them to form graphics as well as alphanumeric characters. Though EVMB are able to form required signs for work zones, they are not to be used in the place of required signs. "Full matrix" displays are not an essential feature of EVMB, but they are recommended because they allow greater variance in the types of display and size of font.

Portability

EVMB can be mounted on a truck or trailer.

Section:

ADDITIONAL DEVICES

Subject:

ELECTRONIC VARIABLE
MESSAGE BOARDS**Placement of EVMB**

Placement should take into account the following factors:

- The lettering must be legible from a distance of 300 m under ideal conditions.
- The EVMB located where a real need is perceived, so drivers will be more apt to respond.
- The EVMB operation shall not interfere with the visibility or general effectiveness of any other signs or devices.
- Visual clutter should be avoided when placing EVMB so that the motorist is not distracted.
- Do not place near exits, merges, intersections, etc.
- EVMB be placed in advance of predicted queues.
- EVMB are normally placed on the right shoulder of the roadway.
- EVMB that are not used in conjunction with a radar unit can be placed on both sides of a double-lane highway work zone provided that the messages are synchronized.
- The boards should be turned three degrees away from perpendicular to the direction of travel to reduce glare.
- The board shall be installed such that it has two metres minimum vertical clearance to reduce glare, enhance sight distance and increase visibility.
- The board should be level.
- EVMB shall be used on all construction and maintenance projects, lasting five days or longer, on the 1A and 1B Highways as identified in the Preservation Highways Hierarchy (TCDMWZ 910) or as specified in the contract. The contractor may wish to consider the application of the device on other project locations to supplement their traffic accommodation plan.

EVMB Messages

Messages should be designed to take into account the following factors:

- No more than two displays within a message cycle.
- Each display should be a single one to three word statement.
- Messages as brief as possible.

Section:**ADDITIONAL DEVICES****Subject:****ELECTRONIC VARIABLE
MESSAGE BOARDS**

- Abbreviations avoided if possible. When they are used they should be easily understood.
- The entire message cycle must be able to be read at least twice when driven at the posted speed or the anticipated operating speed.
- Messages not to scroll horizontally or vertically across the face of the sign.
- Avoid general messages such as “DRIVE SAFELY” or “HAVE A NICE DAY.”
- Only use verified information to ensure credibility. The message displayed shall not contradict with other signs and devices being used.
- Should be updated immediately as work zone circumstances change to maintain a high standard of validity to motorists.

TRAFFIC CONTROL DEVICES
MANUAL FOR WORK ZONES

Section:

ADDITIONAL DEVICES

Subject:

PORTABLE RUMBLE STRIPS

PORTABLE RUMBLE STRIPS

Portable rumble strips are made of rubber-like material placed perpendicular to the path of vehicles and across the full width of the shoulder and travelled lane. The purpose is to alert inattentive drivers of hazards that may not be readily apparent but which require substantial speed reduction or other cautionary manoeuvres. Portable rumble strips have the same effect as the rumble strips made with pavement, with the benefit of being easier to use and less expensive.

Rumble strips are practical for stationary and slow moving work zones and for short to long duration projects. If the work zone is moving quickly, the installation and removal of the rumble strips may become impractical.

Types of Rumble Strips

Rumble strips are a rubber mat device approximately 325 mm wide x 18 mm high extending across the approach lane of the highway.

Specifications

Rumble strips must:

- Generate a sufficient audible noise when traversed by the wheels of a vehicle as to alert the driver.
- Generate a distinct vibration when traversed.
- Be designed so as not to compromise the safety of the roadway for traffic.
- Be selectively located with respect to the potential hazard so as to maximize their effectiveness.
- The device's length should be adjustable in order to span the entire width of the roadway.
- Be well suited for quick and efficient emergency removal and lightweight to provide maximum mobility.
- The materials used be sufficiently strong to prevent unexpected failure, as well as sufficiently durable to withstand the wear caused by traffic.

Section: **ADDITIONAL DEVICES**

Subject: **PORTABLE RUMBLE STRIPS**

Placement of Rumble Strips

Rumble strips shall be used on all construction and maintenance projects, lasting five days or longer, on the 1A and 1B Highways as identified in the Preservation Highways Hierarchy or as specified in the contract. The contractor may wish to consider the application of the device on other project locations to supplement their traffic accommodation plan.

Additional sets of rumble strips may be used as required.

The rumble strips shall be removed when no workers are present.

Two sets of three rumble strips should be placed 15 m apart, 90 - 150 m prior to the regulatory speed sign. The spacing between individual strips in each set is 2 metres.

Typical 4 Lane

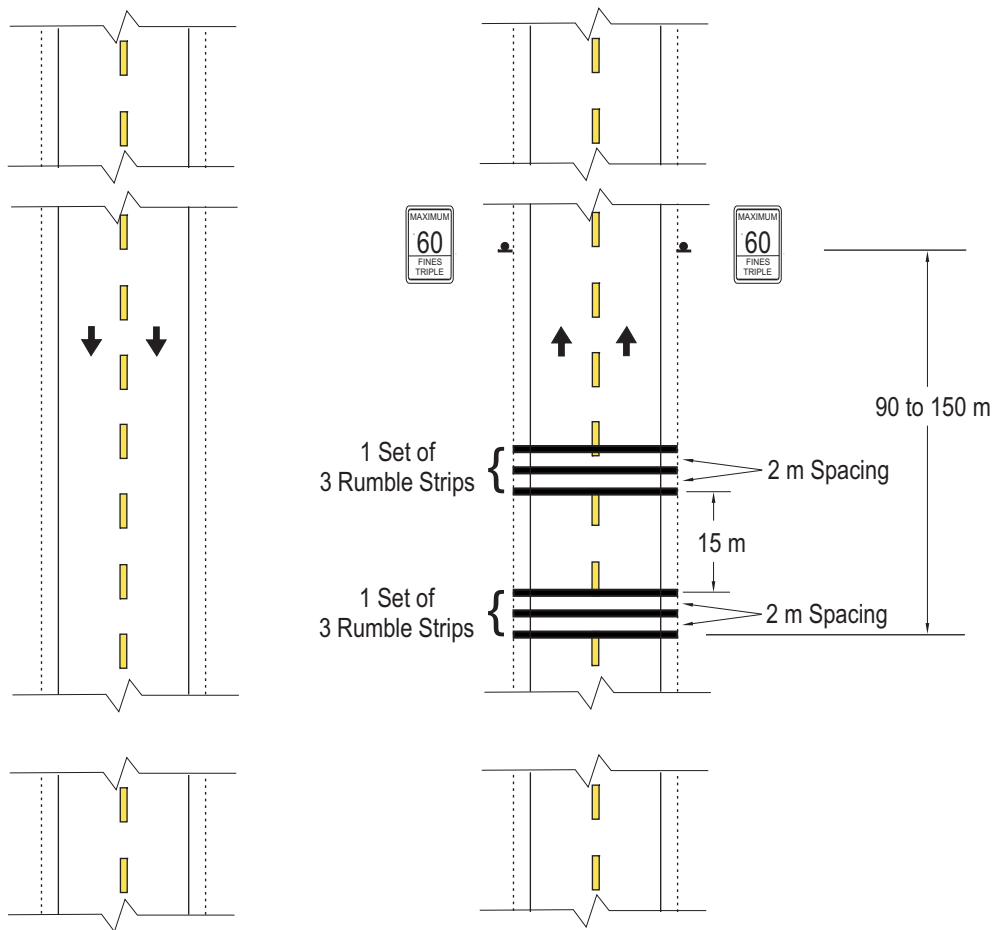

Section: **ADDITIONAL DEVICES**

Subject: **PORTABLE RUMBLE STRIPS**

Typical 2 Lane

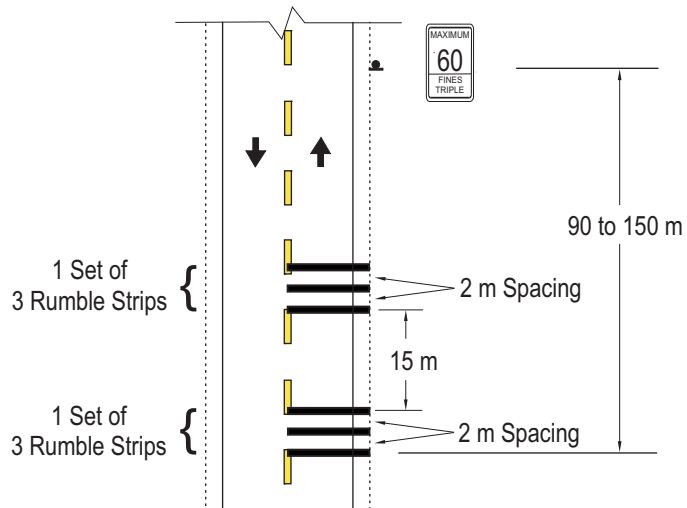
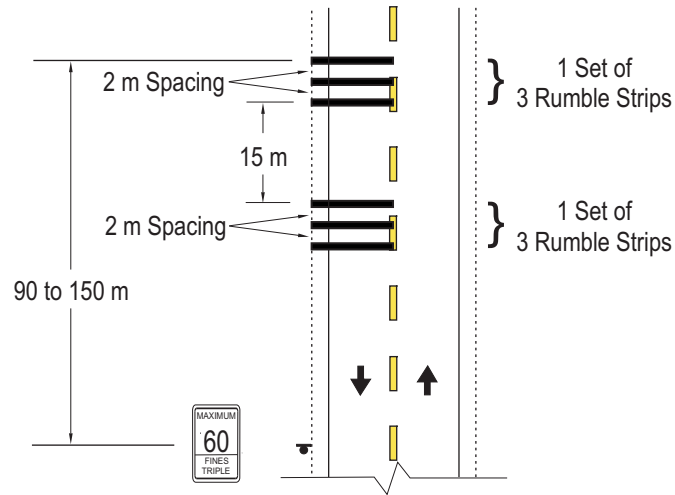

THIS PAGE INTENTIONALLY LEFT BLANK

TRAFFIC CONTROL DEVICES
MANUAL FOR WORK ZONES

Section:

ADDITIONAL DEVICES

Subject:

DUPLICATION OF KEY SIGNS

Duplication of Key Signs

Duplication of key signs is used to supplement work zone signing. The duplication of key signs give the motorist heightened visual awareness of what driving behaviour to adhere to.

Duplication of key signs is practical for long duration work on major construction projects with higher traffic volumes, on two way highways.

Specifications

The key signs to be duplicated are the WD-A41 (Road work ahead), Regulatory signs, which include the CS-46C (Max 60 with Fines Triple), RB-32 (Do not pass), and the WD-A45 (Flagperson) sign.

Signs shall be duplicated every time they appear throughout the work zone.

Placement of Duplication of Key Signs

Duplication of key signs shall be used on all construction and maintenance projects, lasting five days or longer, on the 1A and 1B Highways as identified in the Preservation Highways Hierarchy (TCDMWZ 910) or as specified in the contract. The contractor may wish to consider duplicating signs on other project locations to supplement their traffic accommodation plan.

The assembly shall be positioned as shown on the following page.

Section: **ADDITIONAL DEVICES**

Subject: **DUPLICATION OF KEY SIGNS**

TYPICAL PLAN

* CODE	REGULAR OR WZ SPEED LIMIT	0 - <60 km/h (m)	60 - 100 km/h (m)
1	LANE CLOSURE TAPER LENGTH	40 - 74	75 - 150
2	DISTANCE BETWEEN MARKERS	5 - 9	10 - 15
3	DISTANCE BETWEEN SIGNS	30 - 89	90 - 150

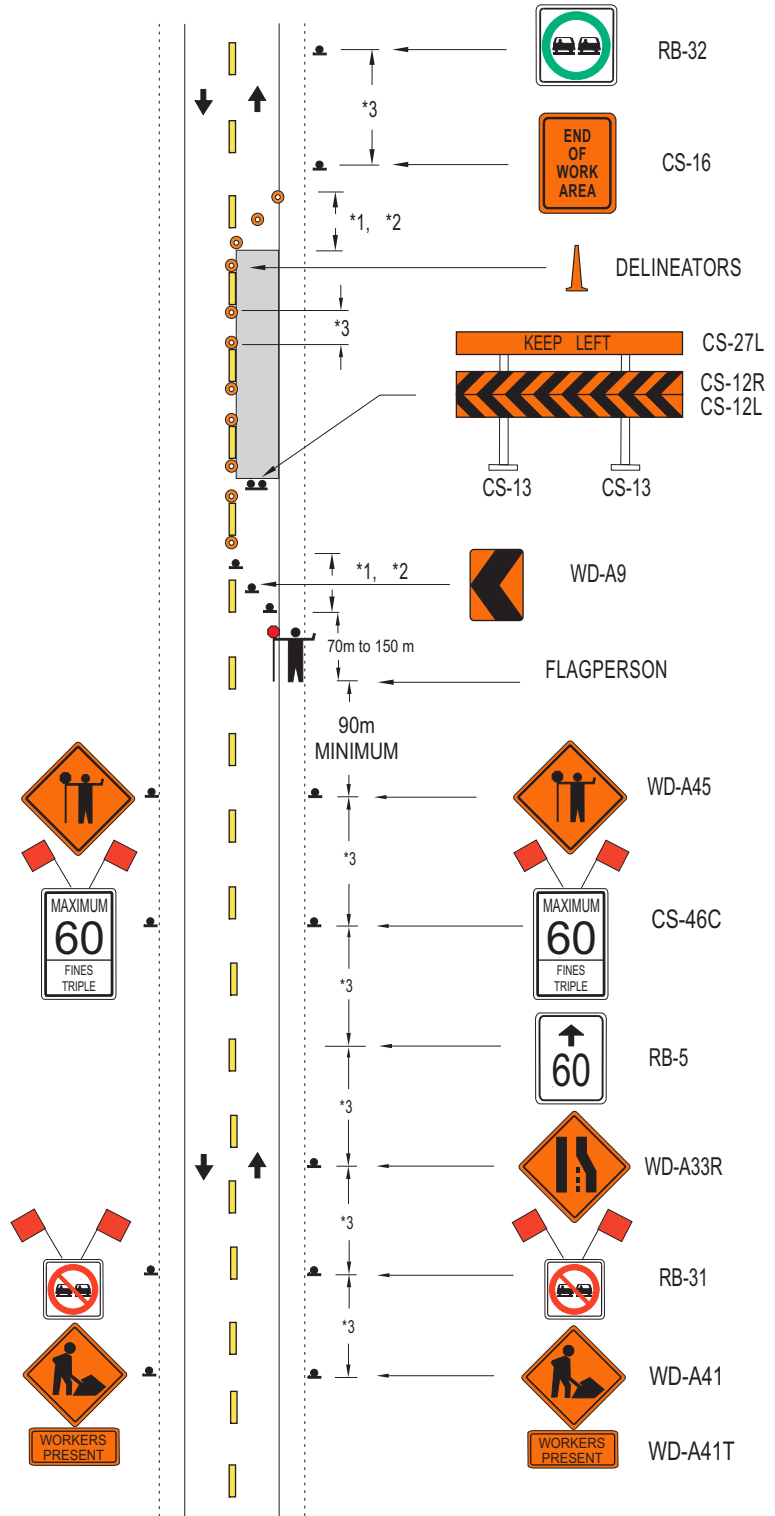

**TRAFFIC CONTROL DEVICES
MANUAL FOR WORK ZONES**

Section:

ADDITIONAL DEVICES

Subject:

LANE WIDTH REDUCTION

**LANE WIDTH
REDUCTION**

Lane width reduction uses traffic cones or similar delineation devices (see TCDMWZ section 502) to effectively narrow the driving lanes. The driver views the narrower lanes as a threat, and will slow down.

Lane width reduction is effective for most static work zone situations. It may not be practical for fast moving work zones. In some situations, such as pavement drop-offs, where delineators are already required, lane width reduction would be a very simple method to implement. For projects such as long term bridge construction or maintenance, it may be more feasible to use barriers, whereas for most highway projects, other delineators would likely be the best option.

Types of Delineators

Delineation devices can include cones (including tubular delineators), drums, striping, barriers, barricades, etc. The cost, maintainability, effectiveness and safety of the devices varies, and the supervisor of operations or the Traffic Accommodation Supervisor has to decide which type to use.

Placement of Delineators

Lane widths of 3 to 3.5 m is recommended for use of lane width reduction as a speed control technique. Generally, the narrower the lane, the slower the traffic. Lanes that are too narrow can lead to erratic maneuvers and speed differentials.

The taper length and spacing of the delineators is outlined in section TCDMWZ 502.

TRAFFIC CONTROL DEVICES
MANUAL FOR WORK ZONES

Section:

ADDITIONAL DEVICES

Subject:

AUTOMATED SPEED ENFORCEMENT

**AUTOMATED SPEED
ENFORCEMENT**

Automated speed enforcement is proven to be a useful addition to work zones. It is intended to increase compliance in areas where motorists are violating the speed limit.

**Placement of Automated
Speed Enforcement**

Automated speed enforcement should be located as close as practical to the work area. The Traffic Accommodation Supervisor should communicate with the automated speed enforcement officer to agree on a safe and visible location for the law equipment to be placed.

Automated Speed Enforcement signs (ID-33 and ID-33T) shall be used on all projects where automated speed enforcement is being used and on construction and maintenance projects, lasting five days or longer. ID-333T shall be installed on all divided highway construction and maintenance projects lasting five days or longer where automated speed enforcement is being used to identify the end of the photo enforcement.

The contractor may wish to consider the application of the signs on other project locations to supplement their traffic accommodation plan.

Automated Speed Enforcement signs (ID-33 ID-33T, and ID-333T) shall be covered or removed when no workers are present.

The assembly shall be positioned as shown on the following page.

**Requesting Automated
Speed Enforcement**

For automated speed enforcement, contact the Southern Region Office Coordinator.

For periodic or one-time traditional law enforcement in the work zones, contact:

- The Royal Canadian Mounted Police (RCMP) detachment in the work zone area, or
- The Regional Enforcement Manager to arrange for Traffic Compliance Officers, to administer speed enforcement.

Section:
ADDITIONAL DEVICES

Subject:
AUTOMATED SPEED ENFORCEMENT

TYPICAL PLAN

* CODE	REGULAR OR WZ SPEED LIMIT	0 - <60 km/h (m)	60 - 100 km/h (m)
1	LANE CLOSURE TAPER LENGTH	40 - 74	75 - 150
2	DISTANCE BETWEEN MARKERS	5 - 9	10 - 15
3	DISTANCE BETWEEN SIGNS	30 - 89	90 - 150

NOTES:

- CORRESPONDING TRAFFIC CONTROL DEVICES EXCEPT WD-A33 WILL BE ERECTED FOR TRAFFIC TRAVELLING IN THE OPPOSITE DIRECTION.
- TC-17 WILL BE USED WHEN NO FLAGPERSON ON DUTY.
- FLASHING LIGHT BOARDS SHOULD BE CONSIDERED ON HIGH VOLUME HIGHWAYS.
- WD-A9 MAY BE REPLACED WITH DELINEATORS IN DAYTIME ONLY.
- ONE FLAGPERSON IS REQUIRED FOR ALL ACTIVITIES IN WHICH ONE LANE IS AFFECTED BY CONSTRUCTION. ADDITIONAL FLAGPERSONS ARE OPTIONAL. FOR WHEN TO SE ADDITIONAL FLAGPERSONS REFER TO TCDM 701.

TWO FLAGPERSONS ARE REQUIRED FOR ALL ACTIVITIES IN WHICH BOTH LANES ARE BEING AFFECTED BY CONSTRUCTION.

FLAGPERSON(S) SHALL BE VISIBLE TO THE MOTORISTS APPROACHING THE WORK ZONE FOR A MINIMUM OF 125 METRES.

- THE REGULATORY SPEED SIGN USED AT THE END OF THE WORK ZONE MUST MATCH THE SPEED LIMIT THAT WAS POSTED PREVIOUS TO THE WORK ZONE.

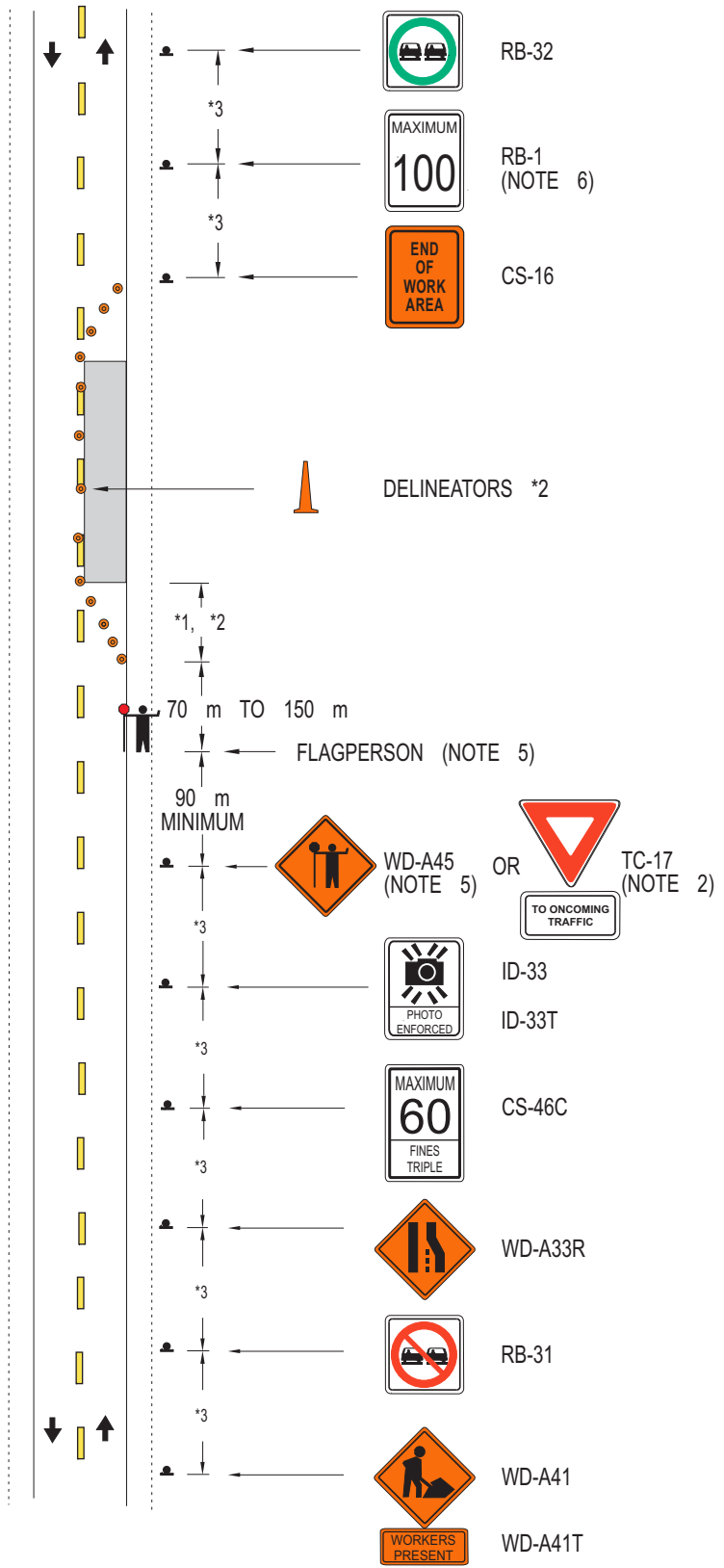

Section:
ADDITIONAL DEVICES

Subject:
AUTOMATED SPEED ENFORCEMENT

TYPICAL PLAN

* CODE	REGULAR OR WZ SPEED LIMIT	0 - <60 km/h (m)	60 - 100 km/h (m)
1	LANE CLOSURE TAPER LENGTH	40 - 74	75 - 150
2	DISTANCE BETWEEN MARKERS	5 - 9	10 -15
3	DISTANCE BETWEEN SIGNS	30 - 89	90 -150

- NOTES:
- CORRESPONDING TRAFFIC CONTROL DEVICES EXCEPT WD-A33 WILL BE ERECTED FOR TRAFFIC TRAVELLING IN THE OPPOSITE DIRECTION.
 - FLASHING LIGHT BOARDS SHOULD BE CONSIDERED ON HIGH VOLUME HIGHWAYS.
 - WD-A9 MAY BE REPLACED WITH DELINEATORS IN DAYTIME ONLY.
 - ONE FLAGPERSON IS REQUIRED FOR ALL ACTIVITIES IN WHICH ONE LANE IS AFFECTED BY CONSTRUCTION. ADDITIONAL FLAGPERSONS ARE OPTIONAL. FOR WHEN TO SE ADDITIONAL FLAGPERSONS REFER TO TCDM 701.
- TWO FLAGPERSONS ARE REQUIRED FOR ALL ACTIVITIES IN WHICH BOTH LANES ARE BEING AFFECTED BY CONSTRUCTION.
- FLAGPERSON(S) SHALL BE VISIBLE TO THE MOTORISTS APPROACHING THE WORK ZONE FOR A MINIMUM OF 125 METRES.
- THE REGULATORY SPEED SIGN USED AT THE END OF THE WORK ZONE MUST MATCH THE SPEED LIMIT THAT WAS POSTED PREVIOUS TO THE WORK ZONE.

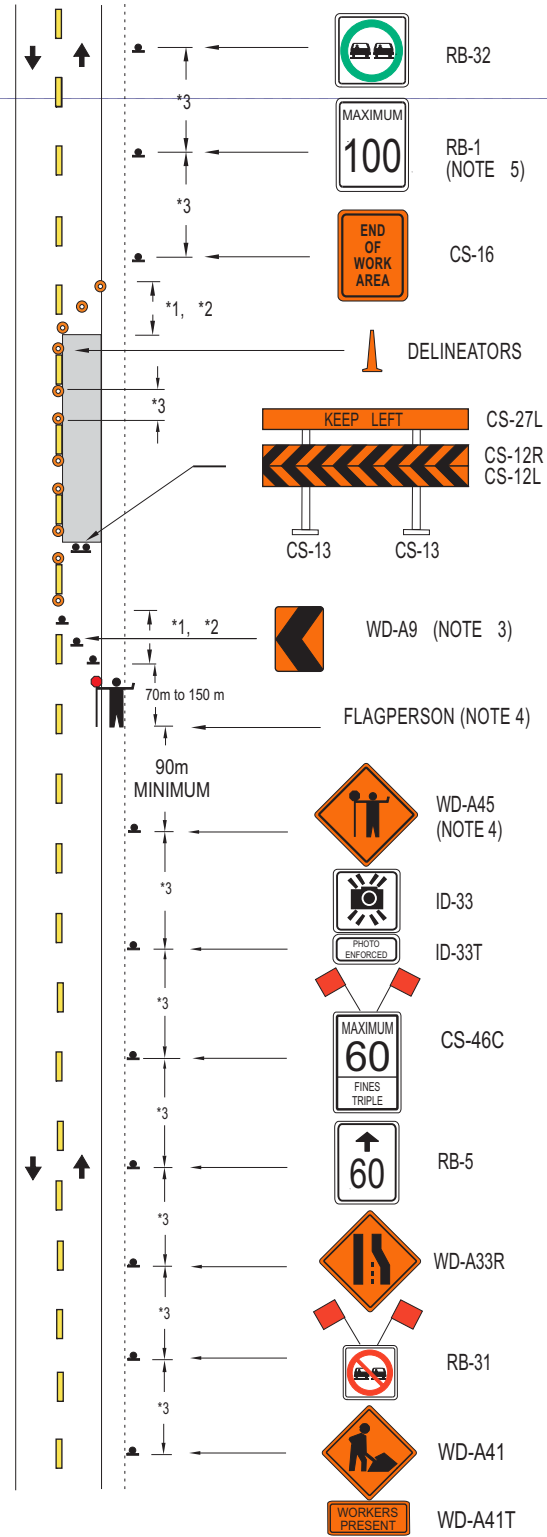

Section: **ADDITIONAL DEVICES**

Subject: **AUTOMATED SPEED ENFORCEMENT**

TYPICAL PLAN

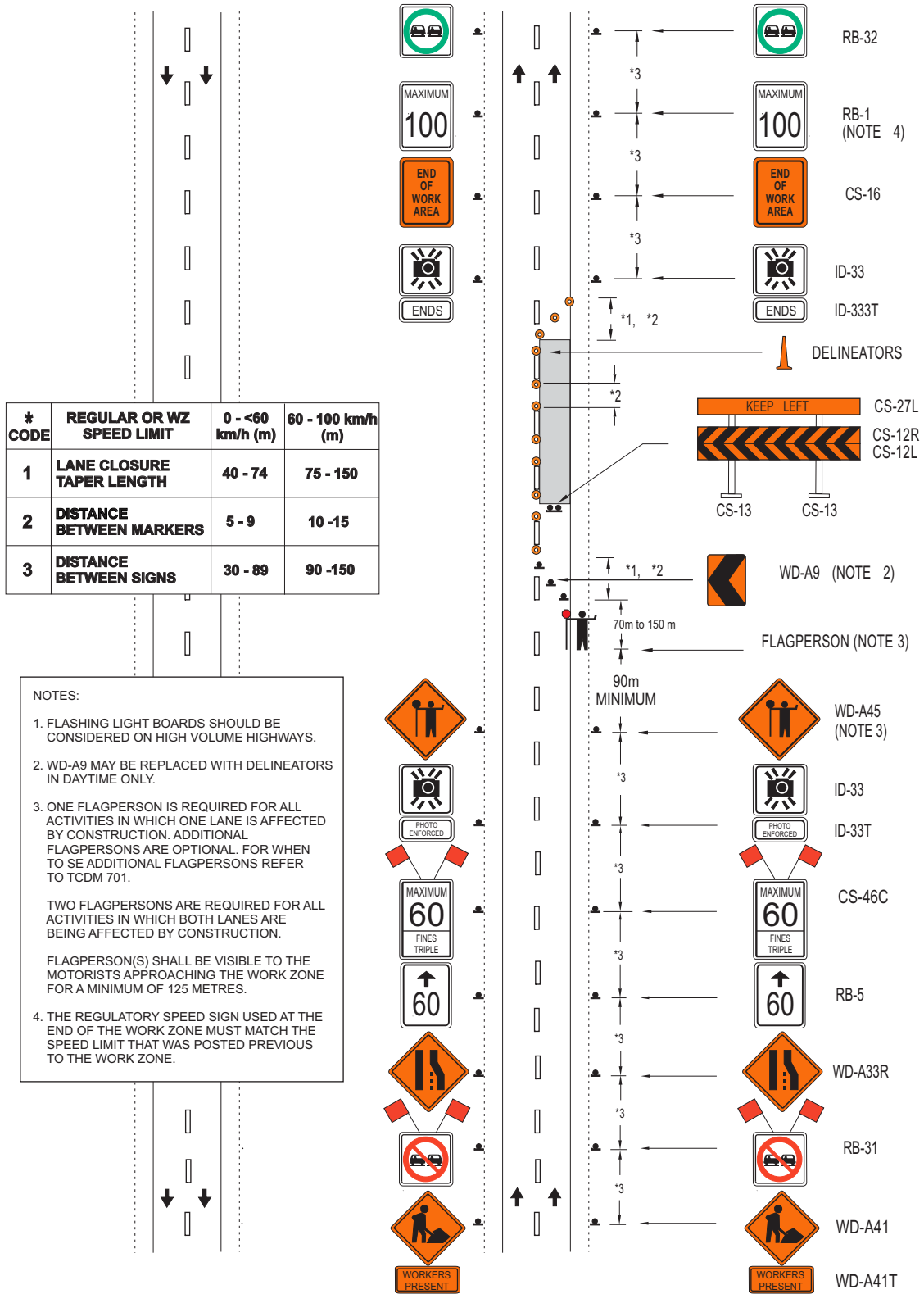

TRAFFIC CONTROL DEVICES
MANUAL FOR WORK ZONES

Section:
ADDITIONAL DEVICES

Subject:
GATEWAY ASSEMBLIES

Gateway Assemblies

Gateway assemblies are used to denote the outer limits of a construction project. These assemblies give the motorist heightened visual awareness that they are entering a construction area. They are effective in alerting the motorist of a different driving environment.

Gateway assemblies are practical for long duration work on major construction projects with higher traffic volumes. They are also effective where the construction signs may be inconspicuous due to visual distraction from other signs or roadside development.

Specifications

Gateway Assemblies consists of three 240 mm x 3600 mm double sided barricade boards (CS-12DR/L). Each board has a reflectivity of at least type IV and has wide orange and black diagonal strips on one side and wide white and black diagonal strips on the other. The barricade boards (CS-12DR) are installed on gateway assemblies placed to the right of traffic and the barricade boards (CS-12DL) are installed on those placed to the left.

Each gateway assembly is equipped with either Construction Ahead sign (CS-33), with a WD-A28S tab if necessary, or a Construction Ends sign (CS-14).

Gateway boards (CS-12DR/L) and associated signs (CS-33 and CS-14) should be mounted on 100 mm x 100 mm wooden posts. The gateway assemblies must be supported with sufficient structure to maintain the position of the boards and signs for the duration of the project.

Placement of Gateway Assembly

Gateway Assemblies shall be used on all construction and maintenance projects, lasting five days or longer, on the 1A and 1B Highways as identified in the Preservation Highways Hierarchy (TCDMWZ 910) or as specified in the contract. The contractor may wish to consider duplicating signs on other project locations to supplement their traffic accommodation plan.

Gateways shall be installed at a minimum of 600 m outside of the construction limits of the project. A gateway assembly shall be installed on each side of the roadway and perpendicular to the roadway. It shall be installed on the sideslope starting at the break point of the shoulder. The assembly shall be positioned as shown on the following pages.

Gateways are to be removed when construction signs are removed at project completion or at season shut-down.

Section: **ADDITIONAL DEVICES**

Subject: **GATEWAY ASSEMBLIES**

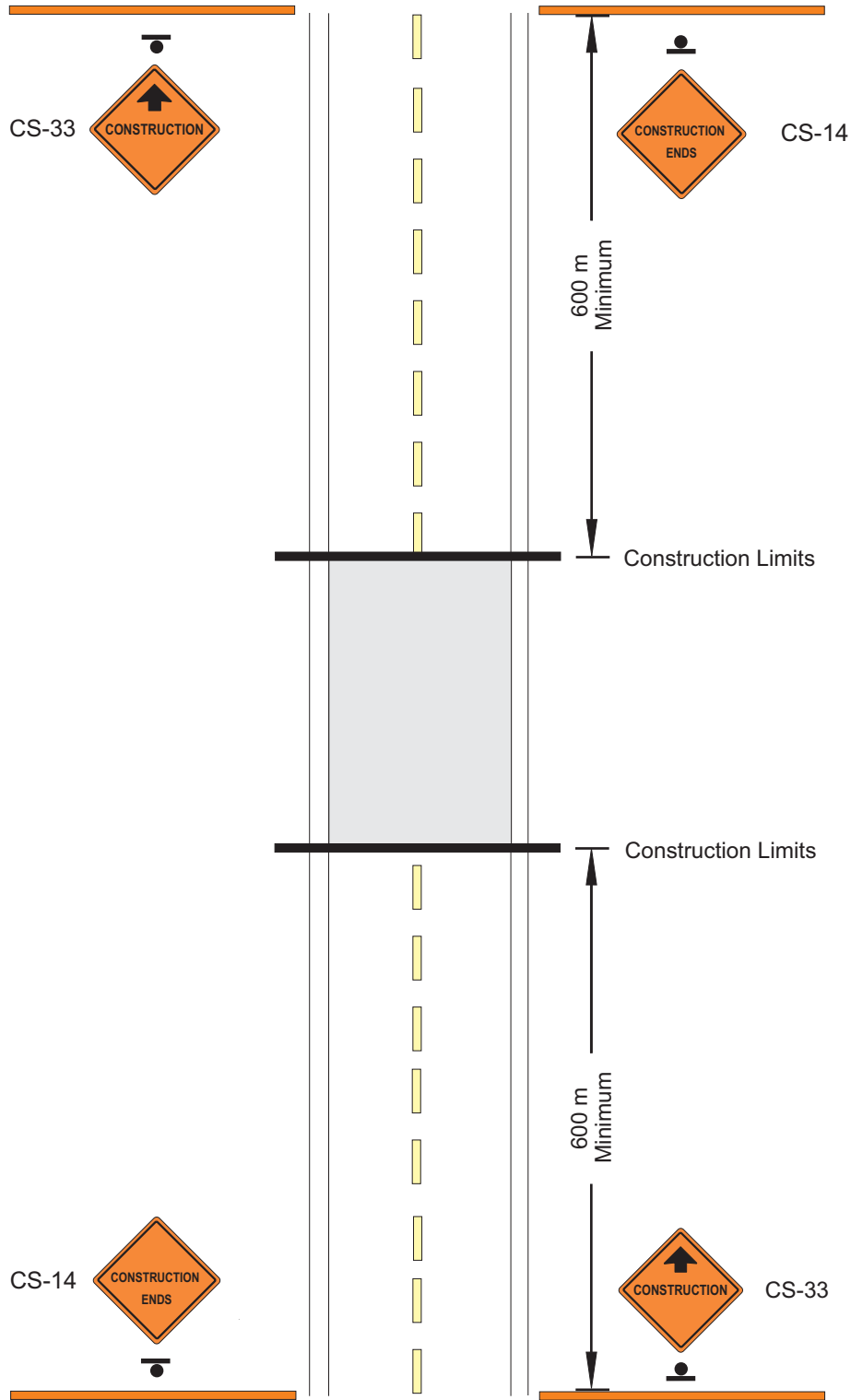

Section: **ADDITIONAL DEVICES**

Subject: **GATEWAY ASSEMBLIES**

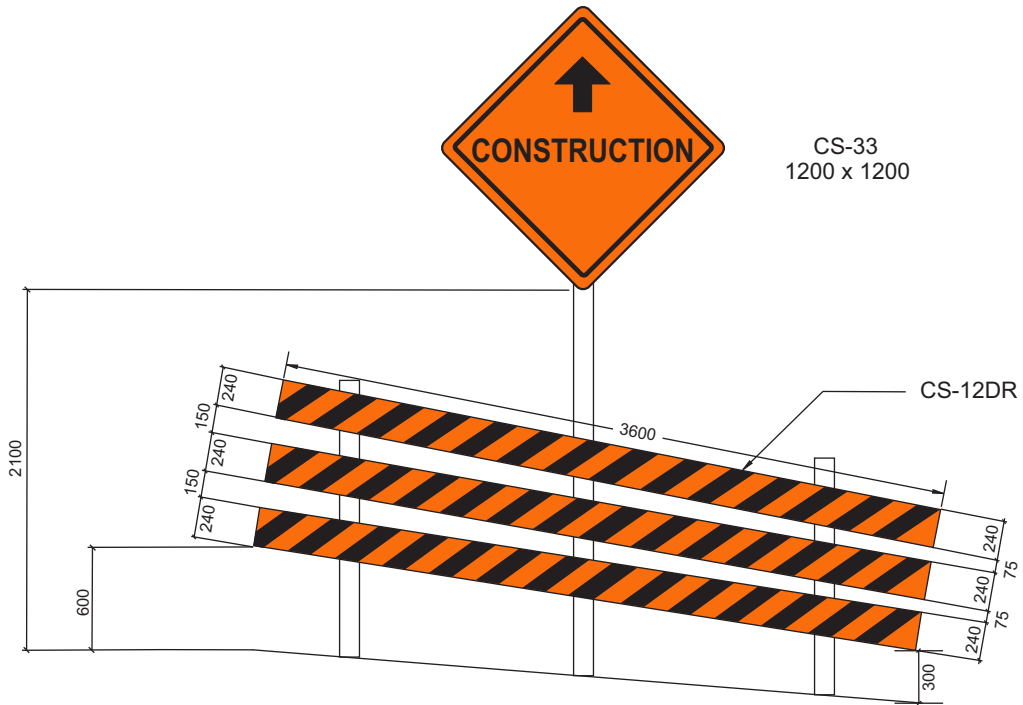

ENTERING A WORK ZONE

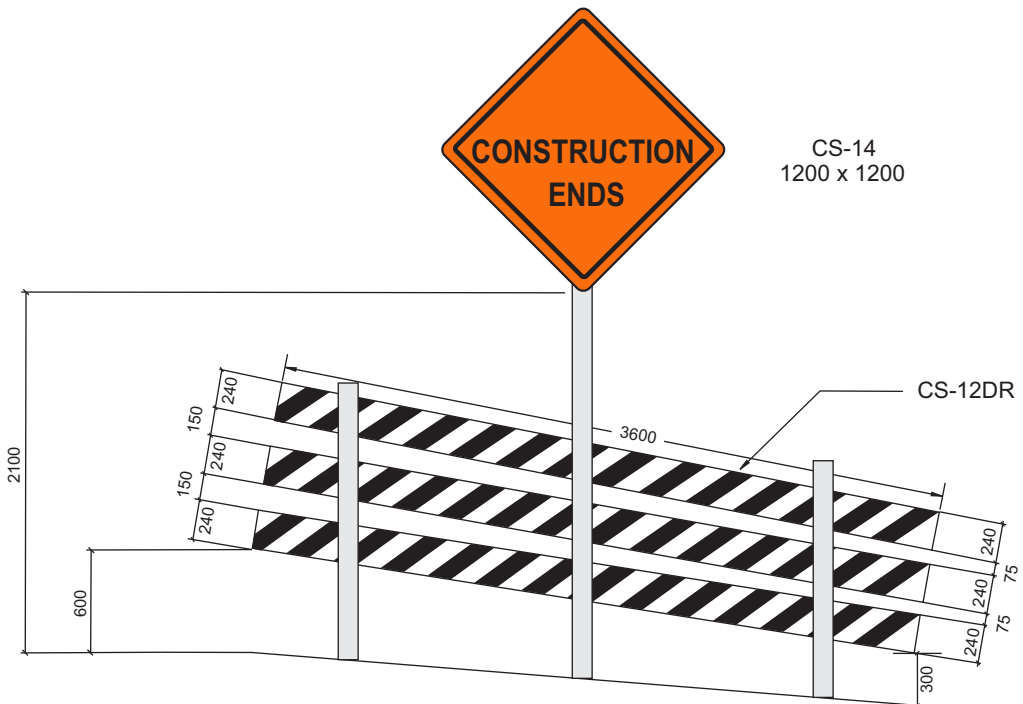

EXITING A WORK ZONE

- All dimensions shown in mm

Section: **ADDITIONAL DEVICES**

Subject: **GATEWAY ASSEMBLIES**

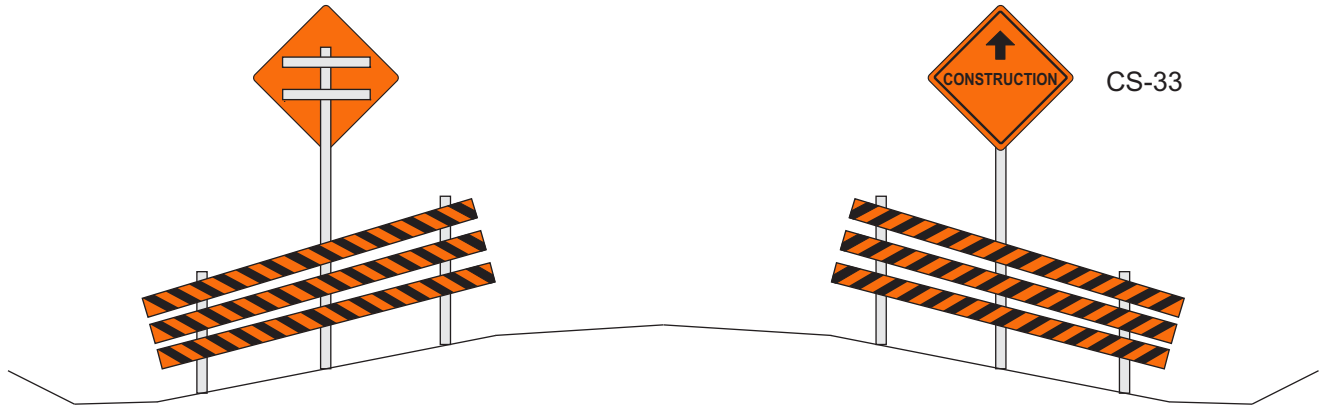

ENTERING A WORK ZONE

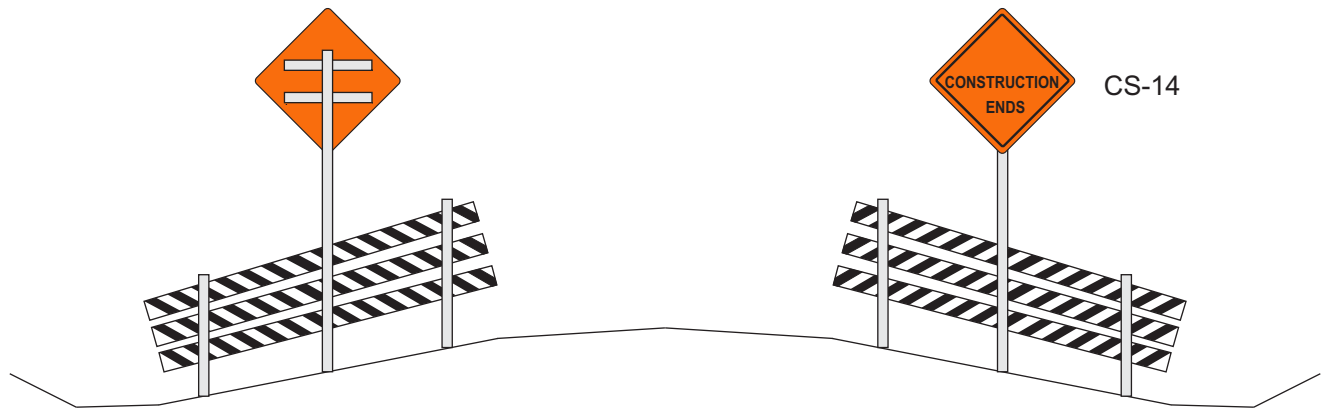

EXITING A WORK ZONE

TRAFFIC CONTROL DEVICES
MANUAL FOR WORK ZONES

Section:

ADDITIONAL DEVICES

Subject:

RADAR SPEED FEEDBACK SIGNS

**RADAR SPEED
FEEDBACK SIGNS**

Radar speed feedback signs are signs that relay vehicle speeds back to the motorist. The most common type of device is one that utilizes radar or other device to detect speeds then relays that information back to motorists via a changeable message display.

Although there are a wide variety of radar speed feedback signs, signs typically consist of a radar assembly with an electronic board which displays the drivers speed. Alternatively the signs may be accompanied with warning devices such as flashing lights to alert the driver that they are travelling in excess of the posted speed limit.

Radar speed feedback signs are practical for all work zone situations from stationary to fast moving and for both long and short duration work.

**Operational
Characteristics**

Radar speed feedback signs must meet the following criteria to be considered acceptable for use on construction projects:

- Must show a blank display, be removed or be turned away from the direction of traffic when workers are not present.
- The static background portion of the sign shall meet Ministry standards for retroreflectivity and colour.
- Must be programmable to not display speeds that are in excess of 20 km/hr above posted speeds to discourage “racing”.
- Must capture and display vehicle speeds in km/hr.
- Trailer mounted and pole mounted devices are acceptable however signs must adhere to MHI specifications for lateral and vertical position (TCDMWZ 402).
- Character height shall be at a minimum of 375 mm.
- The installation of radar speed feedback signs shall not interfere with visibility or general effectiveness of any other signs or devices.

Location

Installation shall be the next sign after the regulatory speed sign with tab “FINES TRIPLE”.

Radar speed feedback signs shall be used on all construction and maintenance projects, lasting five days or longer, on the 1A and 1B Highways as identified in the Preservation Highways Hierarchy (TCDMWZ 910) or as specified in the contract. The contractor may wish to consider radar feedback signs on other project locations to supplement their traffic accommodation plan.

TRAFFIC CONTROL DEVICES
MANUAL FOR WORK ZONES

Section:

ADDITIONAL DEVICES

Subject:

SIGN MOUNTED WARNING FLAGS

SIGN MOUNTED WARNING FLAGS Sign mounted warning flags are used to call attention to key signs in the work zone.

Although there are a wide variety of devices that may be used to call attention to key signs, sign mounted warning flags are considered the minimum device to call attention to key signs.

Warning lights and beacons may be used in place of warning flags as long as they meet Ministry of Highways and Infrastructure specifications and are approved for use by the Traffic Accommodation Supervisor.

Sign mounted warning flags signs are practical for all work zone situations from stationary to fast moving and for both long and short duration work.

Criteria for Usage Sign mounted warning flags must meet the following criteria to be considered acceptable for use on construction projects:

- Shall not block the sign face.
- Flags shall be either soft type or rigid metal style and must be bright red or fluorescent orange in colour.
- Sign flags shall not interfere with visibility or general effectiveness of any other signs or devices.

Placement of Sign Mounted Warning Flags

Sign mounted warning flags shall be used on all construction and maintenance projects, lasting five days or longer, on the 1A and 1B Highways as identified in the Preservation Highways Hierarchy (TCDMWZ 910) or as specified in the contract. The contractor or maintenance crews may wish to consider the application of the sign mounted warning flags on other project locations to supplement their traffic accommodation plan.

Flags must be used the following signs but may be used on any sign:

- RB - 31 - “NO PASSING” sign
- CS - 46C - “REGULATORY SPEED” sign with “FINES TRIPLE”

TRAFFIC CONTROL DEVICES
MANUAL FOR WORK ZONES

Section: ADDITIONAL DEVICES

Subject: PROVINCIAL HIGHWAYS
HIERARCHY

**Provincial Highways
Hierarchy**

A proper provincial highway hierarchy will ensure that important roads are preserved to an appropriate condition under the limited funding and therefore the province gets value for the money invested in highways. The economic group (1A and 1B) are typically the highest traffic volume routes (map attached page 2).

For further clarification on what Highways are categorized as the economic group (1A and 1B) contact the Regional Director of Asset Management.

Section: **ADDITIONAL DEVICES**

Subject: **PROVINCIAL HIGHWAYS HIERARCHY**

Economic Group (1A, 1B)

Legend
— EG All Roads (All Pavement)

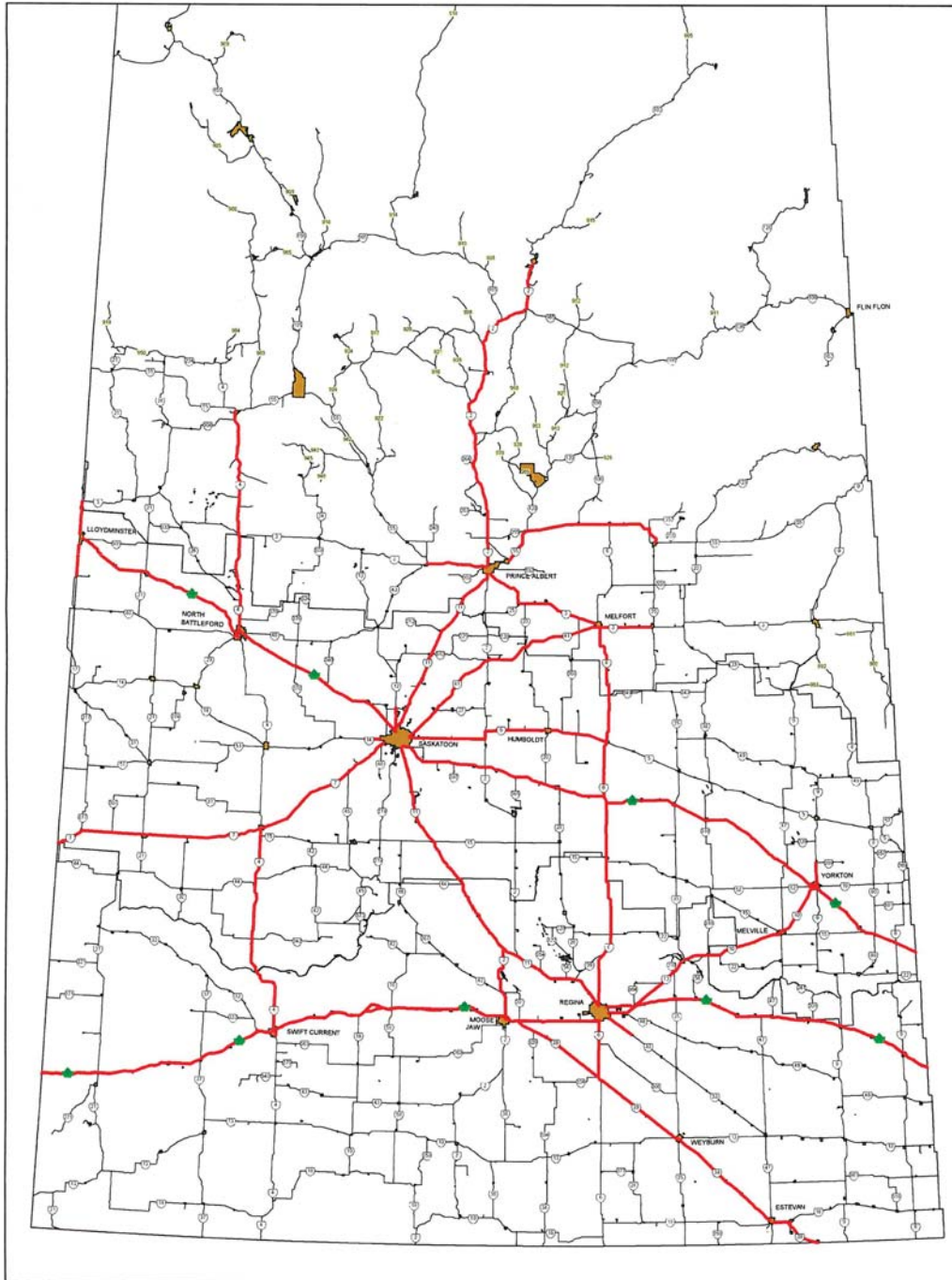

Created By: Adam Nestmann

May 15th, 2012